

PACKED INDUSTRIAL PC WITH PENTIUM-M PROCESSOR

The PIP11 is a low power, highly integrated rugged industrial PC with a specially designed aluminum housing. This allows the PIP11 to operate in a standard or also in a harsh environment without fan or ventilation holes. The design integrates standard connectors for easy connection. It can be used for any PC application where a complete solution is needed. The PIP11 is 100% PC/AT compatible, and can easily be mounted on a 35 mm DIN rail.

The PIP11 housing offers space for a 2.5 inch hard disk and a CD-ROM drive. With the integrated PC/104 (-PLUS) interface flexible expansion possibilities are available. Fully bootable FLASH disks are supported for projects where hard disks cannot be used. Particular precautions have been taken that the EMC for the entire system is within the CE and FCC limits.

All these features make the PIP11 the ideal solution for the industry wherever a flexible, rugged and durable complete Industrial PC is needed.

Features:

- Pentium-M 745 with 1.8 GHz and 2 MByte Level2 Cache
- Intel Mobile Technology components
- Up to 1.5 GB DDR333 memory with ECC
- Up to 512 MB soldered down memory with ECC
- Suspend to Disk (S4) support
- 3D graphics with up to 64 MByte shared memory
- 1 Ethernet port (10M/100M/1G Bit/s)
- 3 FireWire 1394b ports (800 MBit/s)
- 2 USB 2.0 ports (480 MBit/s)
- 2 SATA-I ports (150 MByte/s)
- 2 Ultra DMA-100 IDE ports
- 1 MByte Firmware Hub
- Standard PC interfaces (PS/2, parallel port)
- 2 serial ports with RS232 interface
- 2 serial ports with RS232 or RS485 interface (optional)
- Four full featured PC/104(-PLUS) slots without ISA Master, ISA DMA and ISA End Transfer capability
- Two-Stage watchdog timer with hardware reset capability
- UPS (optional)
- Galvanically isolated power input (optional)
- AC'97 codec (optional)
- CAN interface (optional)
- RoHS compliant

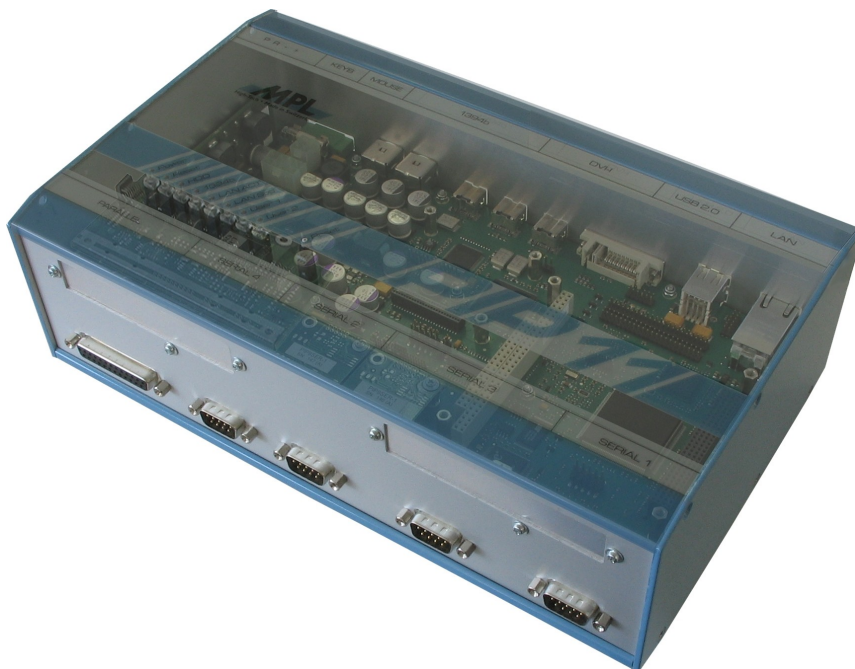

TABLE OF CONTENTS

1 INTRODUCTION..... 6

1.1 ABOUT THIS MANUAL..... 6

1.2 SAFETY PRECAUTIONS AND HANDLING..... 6

1.3 ELECTROSTATIC DISCHARGE (ESD) PROTECTION..... 6

1.4 EQUIPMENT SAFETY..... 6

1.5 MANUAL REVISIONS..... 7

 1.5.1 Related Products..... 7

 1.5.2 Revision History..... 7

1.6 RELATED DOCUMENTATION..... 8

1.7 ORDERING INFORMATION..... 8

2 GENERAL INFORMATION..... 9

2.1 ELECTRICAL..... 9

 2.1.1 Processor..... 9

 2.1.2 Chipset..... 9

 2.1.3 BIOS ROM..... 9

 2.1.4 Memory..... 9

 2.1.5 RTC..... 9

 2.1.6 PC/104-PLUS Interface..... 9

 2.1.7 Graphics..... 9

 2.1.8 USB..... 9

 2.1.9 Serial RS232 Ports..... 9

 2.1.10 RS485/RS422 Interface Modules (Optional)..... 10

 2.1.11 Parallel Port..... 10

 2.1.12 IDE (PATA) Ports..... 10

 2.1.13 SATA-I Ports..... 10

 2.1.14 Floppy Disk..... 10

 2.1.15 FireWire 1394b..... 10

 2.1.16 Ethernet..... 10

 2.1.17 Keyboard / Mouse..... 10

 2.1.18 AC'97 Audio Controller..... 10

 2.1.19 Speaker..... 10

 2.1.20 Indicators..... 11

 2.1.21 Reset Button, Power Button..... 11

 2.1.22 Hardware Watchdog Timer..... 11

 2.1.23 Temperature Sensors..... 11

 2.1.24 Specialties..... 11

2.2 PHYSICAL..... 12

 2.2.1 Housing..... 12

 2.2.2 Form factor..... 12

 2.2.3 Weight..... 12

2.3 POWER..... 12

 2.3.1 Power supply..... 12

 2.3.2 Fuse..... 12

 2.3.3 RTC Battery..... 12

 2.3.4 Input Power..... 12

2.4 ENVIRONMENT..... 12

 2.4.1 Temperature Range..... 12

 2.4.2 RELATIVE HUMIDITY..... 12

3 DIMENSIONS.....	13
3.1 TOP VIEW.....	13
3.2 BOTTOM VIEW.....	14
3.3 SIDE VIEW 1.....	15
3.4 SIDE VIEW 2.....	16
3.5 SIDE VIEW 3.....	17
3.6 SIDE VIEW 4.....	17
4 CONNECTORS.....	18
4.1 PARALLEL PORT (J2) CONNECTOR.....	18
4.2 SERIAL-1 (J46) AND SERIAL-3 (J35) CONNECTOR.....	19
4.3 SERIAL-2 (J21) AND SERIAL-4 (J10) CONNECTOR.....	19
4.4 EXTERNAL POWER (J1) CONNECTOR.....	20
4.4.1 External Power Connector Pin Out.....	20
4.4.2 Mounting An External Reset And Power Button.....	20
4.4.3 Power Up Behaviour.....	20
4.5 PS/2 KEYBOARD (J8) AND MOUSE (J9) CONNECTORS.....	21
4.6 FIREWIRE 1394b (J26, J20, J15) CONNECTORS.....	21
4.7 DUAL USB (J43) CONNECTOR.....	21
4.8 DVI-I (J30) CONNECTOR.....	22
4.9 10M/100M/1G ETHERNET (J49) CONNECTOR.....	22
5 OPERATION.....	23
5.1 BLOCK DIAGRAMS.....	23
5.2 PC/AT FUNCTIONALITY.....	24
5.3 STATUS INDICATORS.....	24
5.3.1 Power Indicator LED.....	24
5.3.2 Reset Indicator LED.....	24
5.3.3 HDD Indicator LED.....	24
5.3.4 IEEE1394b Indicator LED.....	24
5.3.5 LAN ACT Indicator LED.....	24
5.3.6 LAN Spd Indicator LED.....	24
5.3.7 USER1, USER2 Indicator LEDs.....	24
5.4 BATTERY CIRCUIT.....	24
5.5 HARDWARE WATCHDOG.....	24
5.6 RS485 / RS422 INTERFACES.....	25
6 SOFTWARE.....	26
6.1 BIOS.....	26
6.2 DEVICE DRIVERS.....	26
7 COPYRIGHT.....	29
8 DISCLAIMER.....	29
9 TRADEMARKS.....	29
10 SUPPORT.....	29
10.1 FAQ.....	29
10.2 SERIAL NUMBER AND REVISION.....	29
10.3 CONTACT MPL AG.....	29

TABLE OF FIGURES

Figure 1: PIP Housing Top View..... 12

Figure 2: PIP Housing Bottom View..... 13

Figure 3: PIP Housing Side View 1..... 14

Figure 4: PIP Housing Side View 2..... 15

Figure 5: PIP Housing Side View 3..... 16

Figure 6: PIP Housing Side View 4..... 16

Figure 7: Parallel Port Connector (DSUB 25 female) (Connector: Compona, 329 156-6).... 17

Figure 8: Serial Port Connector (DSUB 9 male) (Connector: Compona, 329 151-6)..... 18

Figure 9: Serial Port Connector (DSUB 9 male) (Connector: Compona, 329 151-6)..... 18

Figure 10: Power Connector (Connector: Phoenix Contact AG, MC1,5/4GF-3,81)..... 19

Figure 11: External Reset and Power Button Switch..... 19

Figure 12: PS/2 Keyboard & Mouse Connector (Connector: Compona, 129108-7)..... 20

Figure 13: FireWire 1394b bilingual Connector (Connector: Molex, 45241-0001)..... 20

Figure 14: Dual USB (Type A) Connector (Connector: FCI, 72309-0010B)..... 20

Figure 15: DVI-I Connector (Connector: Samtec, DVI-29-AW-FT)..... 21

Figure 16: RJ45 Connector (Connector: Bel Fuse 0826-1K1T-23)..... 21

Figure 17: PIP11-1 Block Diagram..... 22

Figure 18: PIP11 Label..... 28

1 INTRODUCTION

1.1 ABOUT THIS MANUAL

This manual, the PIP Technical Reference Manual and the PIP11 BIOS User Manual provides all the information necessary to handle and configure the PIP11.

This manual is written for technical personnel responsible for integrating the PIP11 into their systems.

It is strongly recommended to read this manual before the PIP11 is switched on.

1.2 SAFETY PRECAUTIONS AND HANDLING

For personal safety and safe operation of the PIP11, follow all safety procedures described here and in other sections of the miscellaneous manuals.

- Remove power from the system before installing (or removing) the PIP11, to prevent the possibility of personal injury (electrical shock) and / or damage to the product.
- Handle the product carefully; i.e. dropping or mishandling the PIP11 can cause damage to assemblies and components.
- Do not expose the equipment to moisture.

WARNING

There are no user-serviceable components on the PIP11.

1.3 ELECTROSTATIC DISCHARGE (ESD) PROTECTION

Various electrical components within the product are sensitive to static and electrostatic discharge (ESD). Even a small static discharge can be sufficient to destroy or degrade a component's operation!

With an open housing, do not touch any electronic components. Handle or touch only the unit chassis.

1.4 EQUIPMENT SAFETY

Great care is taken by MPL AG that all its products are thoroughly and rigorously tested before leaving the factory to ensure that they are fully operational and conform to specification. However, no matter how reliable a product, there is always the remote possibility that a defect may occur. The occurrence of a defect on this device may, under certain conditions, cause a defect to occur in adjoining and/or connected equipment. It is your responsibility to protect such equipment when installing this device. MPL accepts no responsibility whatsoever for such defects, however caused.

1.5 MANUAL REVISIONS

1.5.1 Related Products

Revision	Related To
A	• PIP11-1 Rev. A, B

1.5.2 Revision History

Revision	Date	Description
A	2006-09-20	Initial release of this document.
B	2007-04-02	- 2.4.1: Additional information on temperature ranges inserted

1.6 RELATED DOCUMENTATION

The following documents are related to this manual. For detailed Information about a specific PIP11 setting or feature please refer to this additional manuals.

Reference	Description	Available from
[1]	PIP11 BIOS User Manual	MPL AG: www.mpl.ch/t2400.html
[2]	PIP Technical Reference Manual	MPL AG: www.mpl.ch/t2400.html

1.7 ORDERING INFORMATION

The table below gives you an overview of the different PIP11 variants and its features.

Product Name	Product Features
PIP11-1	<ul style="list-style-type: none"> • 1.8 GHz Pentium-M Dothan 745 with 2 MByte Level2 Cache • 512 Myte soldered down On Board DDR333 Memory with ECC • 200 pin DDR333 SO-DIMM socket with ECC (up to 1 GB memory) • 82541PI GBit Ethernet controller • 3 1394b bilingual ports • PC/104 & PC/104-PLUS Interface • 2 RS232 ports, optionally additional 2 RS232 or RS485 ports possible • RoHS compliant
PIP11-xCx	<ul style="list-style-type: none"> • Custom Assembly for series with 100 pieces and more • Please contact MPL AG for further information
	<p>There are also many more options available for:</p> <ul style="list-style-type: none"> • Housing size, displays, touch, IP65 • PC/104-PLUS card -, PCI card -, PC-Card - and CF card extensions • CDROM • UPS, extended Input Power Module • Extended temperature • etc. <p>Please have a look at our homepage for this on www.mpl.ch/t2441.html or contact MPL AG for further information.</p>

2 GENERAL INFORMATION

This chapter provides an overview of the PIP11 and its features. It outlines the electrical and physical specifications of the product and its power requirements.

2.1 ELECTRICAL

2.1.1 Processor

- Pentium-M Dothan 745 1.8 GHz with 2 MByte Level2 Cache in 90 nm technology
- Enhanced Intel SpeedStep technology
- Supports catastrophic thermal protection

2.1.2 Chipset

- Intel 855GME & 6300ESB
- 400-MHz source-synchronous Frontside Bus
- Supports ACPI-defined power states S1 (Stop Grant), S3 (Suspend to RAM), S4 (Suspend to Disk), S5 (Soft Off)

2.1.3 BIOS ROM

- 1 MByte Firmware Hub
- Easy BIOS update
- BIOS source owned by MPL AG

2.1.4 Memory

- DDR333 (PC2700) memory
- Up to 512MByte on board with ECC
- 200 pin SO-DIMM slot supports up to 1 GByte memory with ECC

2.1.5 RTC

- Backed with field changeable on board battery

2.1.6 PC/104-PLUS Interface

- 8/16 bit memory and I/O PC/104 interface
- PC/104 DMA, Master and End Transfer not supported
- 32 bit PC/104-PLUS interface
- Up to 4 PC/104-PLUS bus master (PC/104-PLUS Spec. Rev. 2.0)

2.1.7 Graphics

- Intel IGD (Integrated Graphics Device)
- 250 MHz graphics core with 2D and 3D engine
- Dual Pipe independent display functionality
- 350-MHz, 24-bit RAMDAC
- LVDS port on 1.27mm header supports up to 1600 x 1200 (UXGA) and 1920 x 1080 (tested: 1280 x 1024, 1920 x 1080)
- Digital Video Interface on DVI-I connector supports up to 1600 x 1200 (UXGA) (tested: 1600 x 1200)
- Analog Video Interface on DVI-I connector supports up to 2048 x 1536 (QXGA) @ 75 Hz (tested: 1600 x 1200)
- DVI-I connector is ESD protected

2.1.8 USB

- 3 Ports with 1.5 / 12 / 480 MBit/s (2 external, 1 internal)
- Supports USB keyboards and mice as legacy devices
- ESD protected

2.1.9 Serial RS232 Ports

- 2 full modem serial RS232 ports, 16C550 compatible

- 2 ports can be equipped either with RS232 or with RS485/RS422 interface modules (both optional)
- COM1, COM3 with 16 byte FIFO
- COM2, COM4 with 128 byte FIFO
- Selectable transfer rates up to 230.4 kbaud
- Available on standard DB9 connectors
- ESD protected

2.1.10 RS485/RS422 Interface Modules (Optional)

- 2 galvanically isolated half- or full-duplex ports
- Automatic RS485 half-duplex direction control
- Selectable transfer rates up to 230.4 kbaud
- Available on standard DB9 connectors
- ESD protected

2.1.11 Parallel Port

- IEEE1284 compliant, SPP, EPP1.7, EPP1.9, ECP mode support
- Configurable as LPT1, LPT2, LPT3
- Floppy disk on parallel port mode, with floppy power available
- Available on DB25 connector
- ESD protected

2.1.12 IDE (PATA) Ports

- 2 Ports on 44 pin connectors with Master / Slave capability
- Support of Ultra DMA-100 Mode

2.1.13 SATA-I Ports

- 2 Ports on standard SATA connectors
- Data transfer rates up to 150 MByte/s
- Support of Soft RAID

2.1.14 Floppy Disk

- Up to 2.88 MByte FDD supported
- Signals can be routed to the parallel port connector (for an external floppy)

2.1.15 FireWire 1394b

- TI TSB82AA2 Controller
- 3 Ports on 1394b bilingual connectors support up to 800 MBit/s
- Provides VINCON power over Polyfuse to the FireWire connectors
- ESD protected

2.1.16 Ethernet

- Intel 82541PI 10M/100M/1G Bit/s Ethernet controller
- Connected over 66 MHz / 32 Bit PCI bus
- ESD protected

2.1.17 Keyboard / Mouse

- Available on 6 pin mini DIN connectors (PS/2)
- ESD protected

2.1.18 AC'97 Audio Controller

- AC'97 2.2 compliant
- AC'97 function available over optional extension PCB called SoundPAN-1. With internal Speaker and external, on the user slot available, Line IN, Line OUT, Headphone and MIC interfaces.

2.1.19 Speaker

- Available on an internal 10 pin header

2.1.20 Indicators

- Power (green), CPU OverTemp (yellow blinking) and CPU CatastrophicTemp (green blinking after restart) LED
- Reset (red) and power fail (red blinking) LED
- HDD (IDE and SATA) activity (green) LED
- IEEE1394 activity (yellow) LED
- LAN link (green) and activity (green blinking) LED
- LAN Spd LED (100MBit/s green, 1GBit/s yellow)
- 2 user-programmable LED's (yellow)

2.1.21 Reset Button, Power Button

- Connection for an external remote reset and remote power button
- ESD protected

2.1.22 Hardware Watchdog Timer

- Two-Stage Watchdog with independent count values for each stage
- Configurable granularity from 1 μ s to 10 min

2.1.23 Temperature Sensors

- Monitors the CPU, the on board memory, the switching power supply and the PCB board temperature

2.1.24 Specialties

- UPS function (optional)
- Input voltage up to 48V (optional)
- Galvanic isolated Power Supply input (optional)
- CAN Extension (optional)

2.2 PHYSICAL

2.2.1 Housing

- Aluminum
- No ventilation holes
- Easily mountable on 35 mm DIN rail

2.2.2 Form factor

- Length: 270 mm (10.63 inch) standard version
440 mm (17.32 inch) Wintergarden version with PCI slot extension
- Width: 162 mm (6.38 inch)
- Height: 62.0 mm (2.44 inch) standard version
82.5 mm (3.25 inch)
120 mm (4.72 inch)

2.2.3 Weight

- Typically 2.2 kg (4.85 lb.) (Standard housing, equipped with internal 2.5 inch HDD and CDROM)

2.3 POWER

2.3.1 Power supply

- High-efficiency 6 channel switching regulator module
- ATX behavior (Soft off)
- Power input is ESD protected

2.3.2 Fuse

- 5 x 20 mm, 3.15 AT

2.3.3 RTC Battery

- Lithium coin cell CR2032 (20.0 x 3.2 mm)
- 3 V / 230 mAh
- Field changeable

2.3.4 Input Power

- 8 V_{DC} .. 28 V_{DC}
- Optional 20 V_{DC} .. 48 V_{DC}
- The power usage can change in a wide range according to the needed CPU, memory, graphics and interfaces usage, as examples:
 - 12 W (512 Mbyte DDR333 SDRAM, HD, Windows XP Desktop Screen, GBit ETH Link, V_{IN} = 12 V)
 - 26 W (512 Mbyte DDR333 SDRAM, HD, Windows XP with SiSoft Sandra Burn In Tool, GBit ETH Link, V_{IN} = 12 V)

2.4 ENVIRONMENT

2.4.1 Temperature Range

- Storage temperature range -45°C to 85°C
- Operating temperature range -20°C to +60°C (+32°F to +140°F) (with full CPU, 3D video and memory usage, mounted on a DIN rail with freely natural convection)
- Extended operating temperature range available (screening)

2.4.2 RELATIVE HUMIDITY

- 5% to 95% non-condensing

3 DIMENSIONS

3.1 TOP VIEW

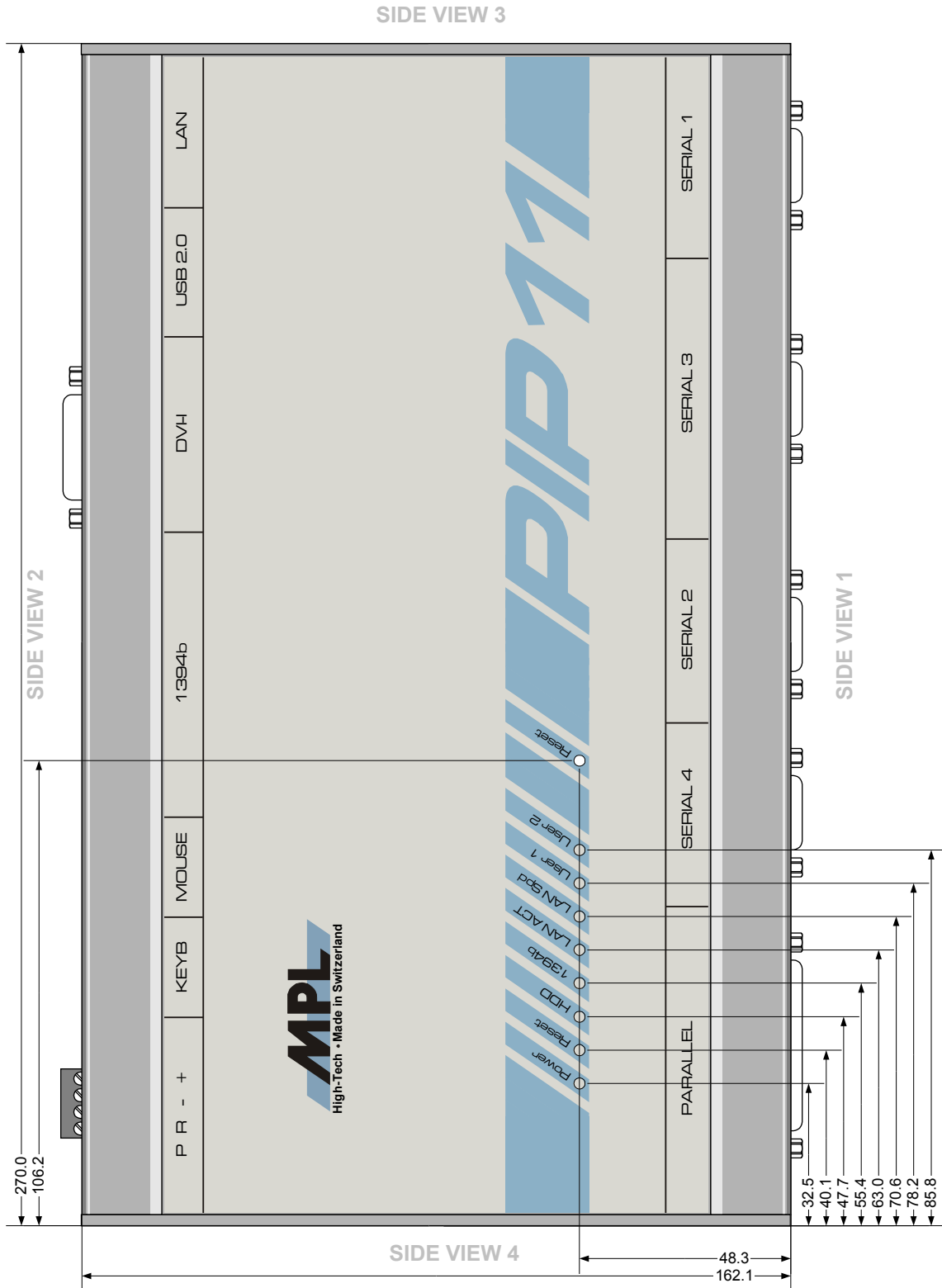

Figure 1: PIP Housing Top View

3.2 BOTTOM VIEW

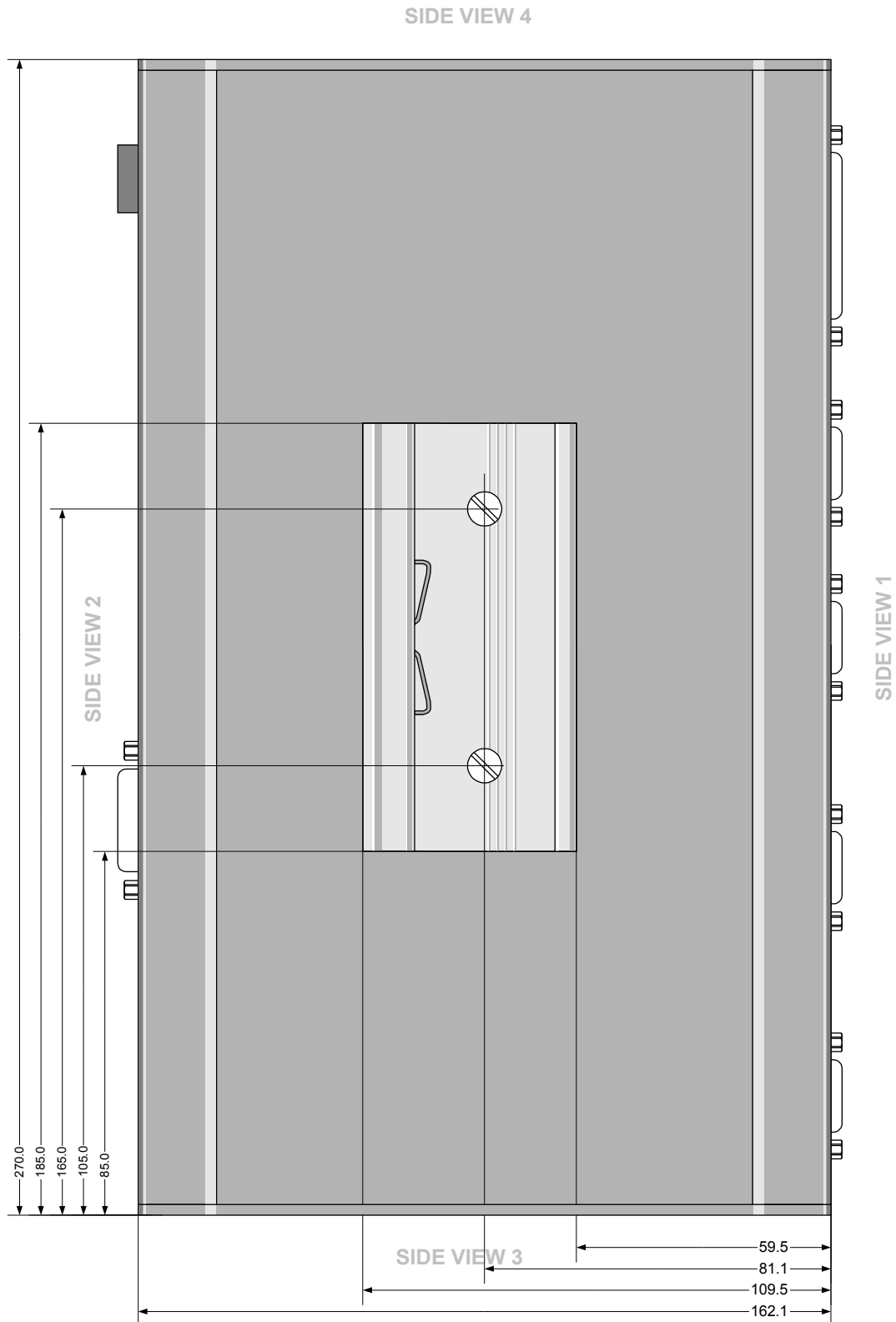

Figure 2: PIP Housing Bottom View

3.3 SIDE VIEW 1

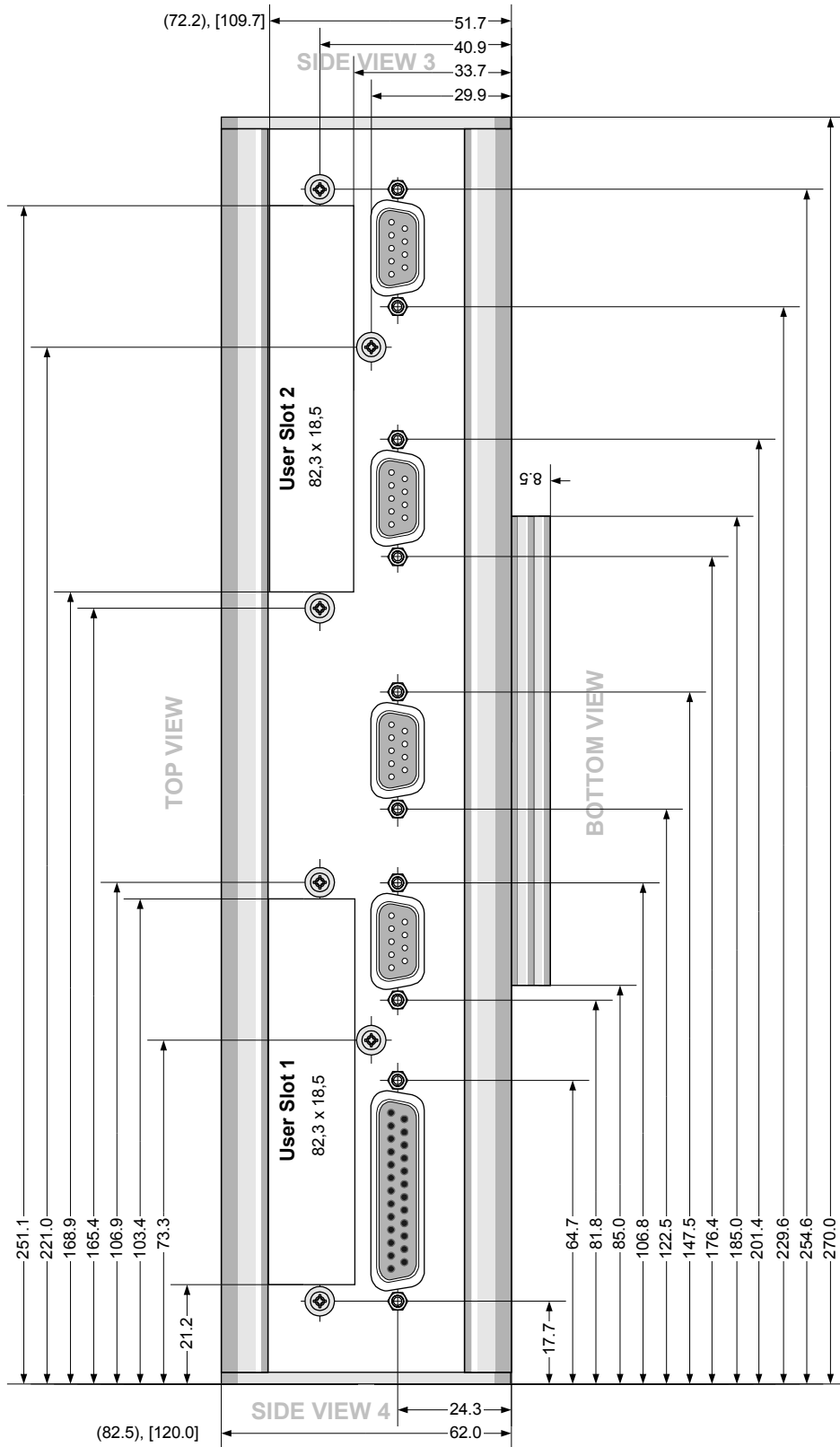

Figure 3: PIP Housing Side View 1

Note: Use the numbers in parentheses for the higher versions (82.5 mm) [120 mm].

3.4 SIDE VIEW 2

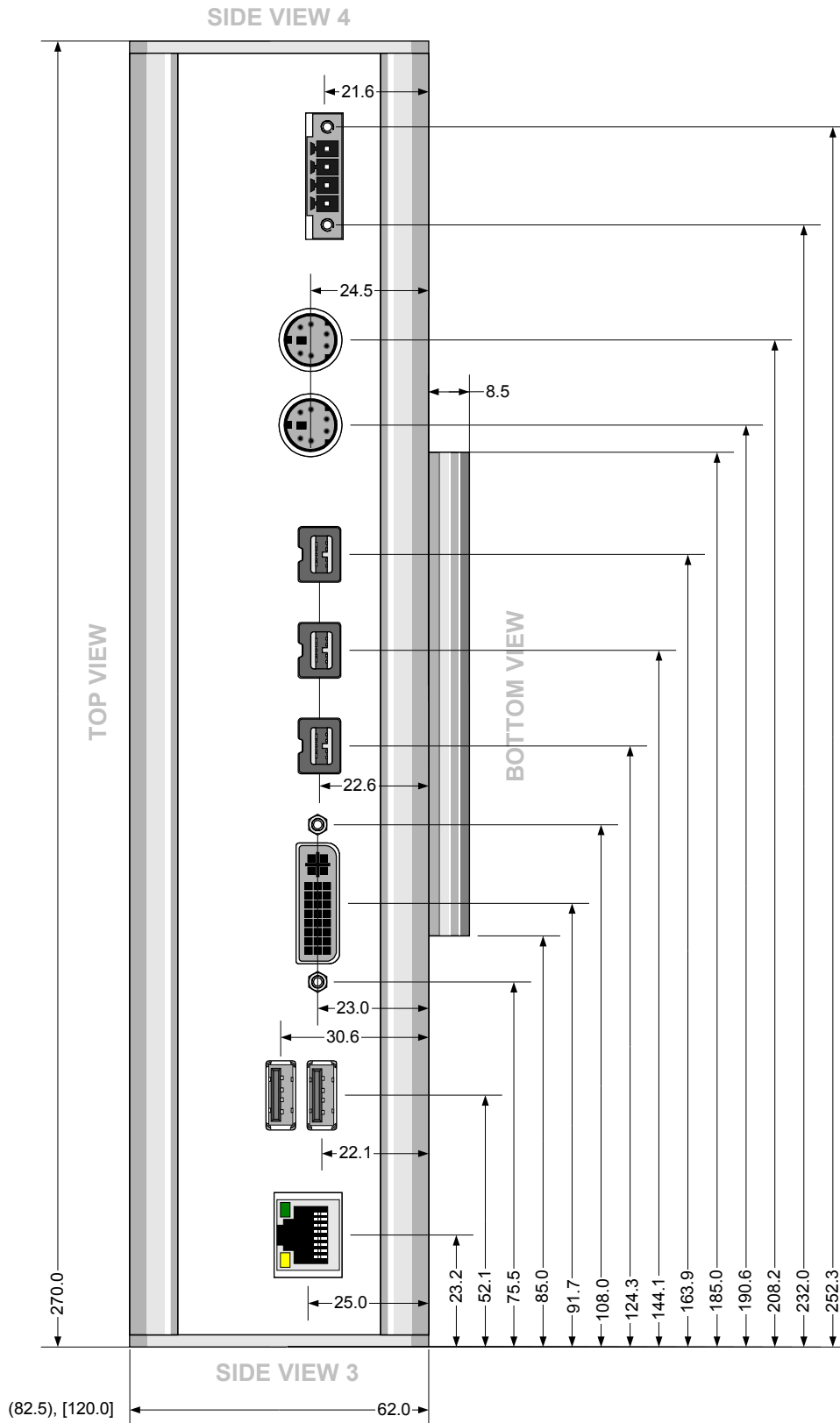

Figure 4: PIP Housing Side View 2

Note: Use the numbers in parentheses for the higher versions (82.5 mm) [120 mm].

3.5 SIDE VIEW 3

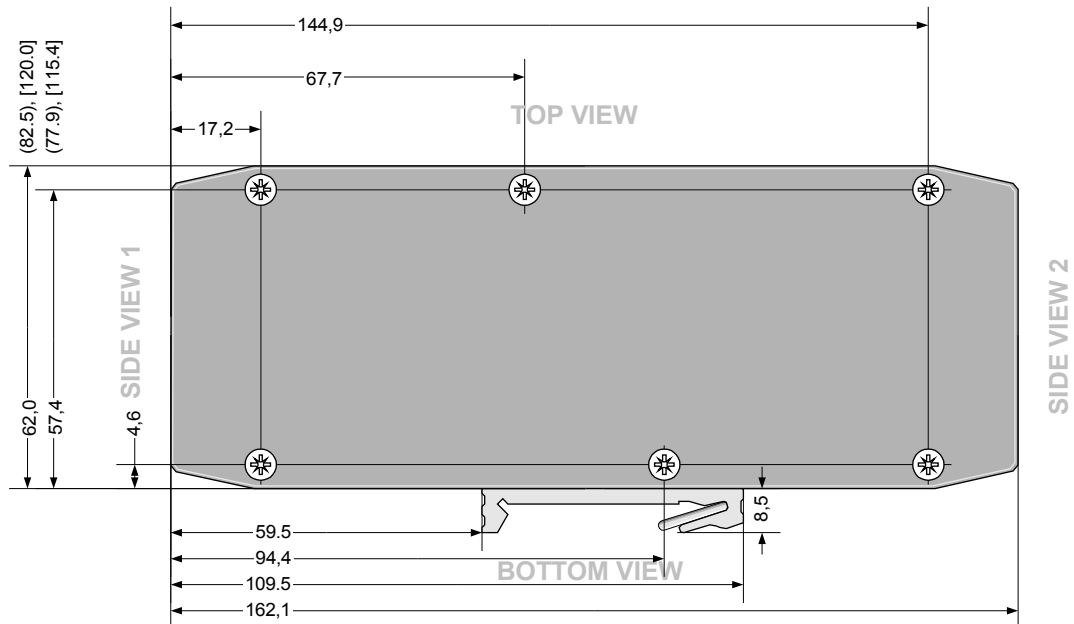

Figure 5: PIP Housing Side View 3

Note: Use the numbers in parentheses for the higher versions (82.5 mm) [120 mm].

3.6 SIDE VIEW 4

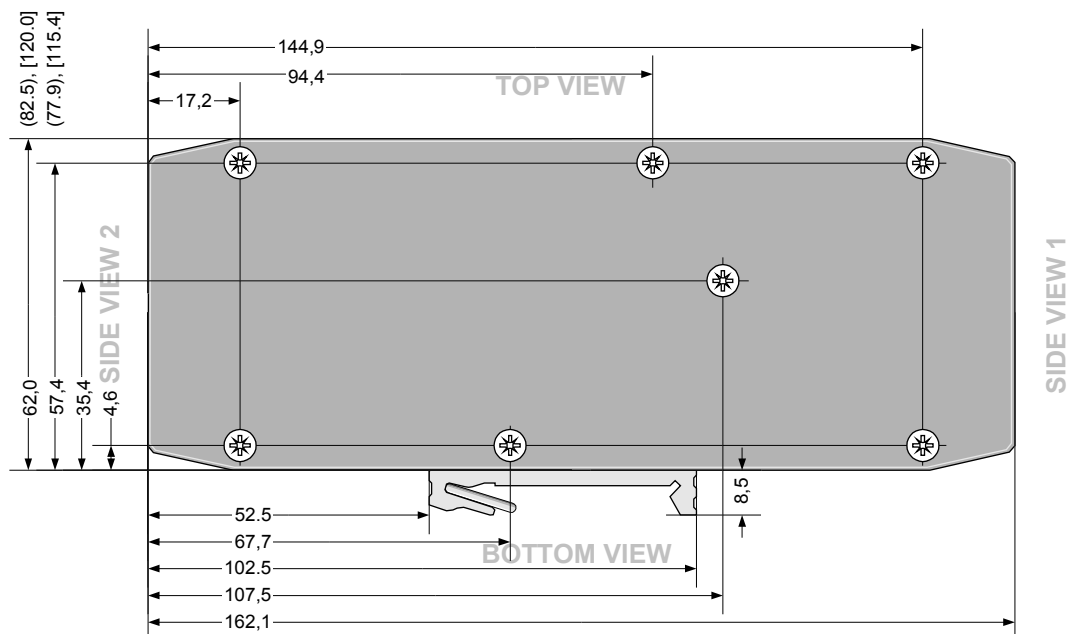

Figure 6: PIP Housing Side View 4

Note: Use the numbers in parentheses for the higher versions (82.5 mm) [120 mm].

4 CONNECTORS

4.1 PARALLEL PORT (J2) CONNECTOR

The parallel port can also operate as an external floppy disk port. The two modes can be switched in the BIOS setup (please refer to the PIP11 BIOS User Manual).

Parallel Port Mode			Pinout
Pin	Signal	Description	
1	STROBE	Strobe	
2	DATA0	Data bit 0	
3	DATA1	Data bit 1	
4	DATA2	Data bit 2	
5	DATA3	Data bit 3	
6	DATA4	Data bit 4	
7	DATA5	Data bit 5	
8	DATA6	Data bit 6	
9	DATA7	Data bit 7	
10	ACK	Acknowledge	
11	BUSY	Busy	
12	PE	Paper empty	
13	SELIN	Select in	
14	AUTOFD	Autofeed	
15	ERROR	Error	
16	/INIT	Initialize	
17	/SEL	Select	
18	GND	Ground	
19	GND	Ground	
20	GND	Ground	
21	GND	Ground	
22	GND	Ground	
23	GND	Ground	
24	GND	Ground	
25	GND	Ground	
Floppy Disk Mode			Pinout
Pin	Signal	Description	
1	DS0	Drive Select 0	
2	IDX	Index	
3	TR00	Track 0	
4	WP	Write Protected	
5	RDATA	Read Data	
6	DSKCHG	Disk Change	
7	MID0	Media ID 0	
8	MTR0	Motor On 0	
9	MID1	Media ID 1	
10	DS1	Drive Select 1	
11	MTR1	Motor On 1	
12	WDATA	Write Data	
13	WGATE	Write Gate	
14	DRV DEN0	Drive Density 0	
15	HDSEL	Head Select	
16	DIR	Direction	
17	STEP	Step	
18	GND	Ground	
19	GND	Ground	
20	GND	Ground	
21	GND	Ground	
22	GND	Ground	
23	GND	Ground	
24	GND	Ground	
25	+5 V / GND	+5 V or Ground	

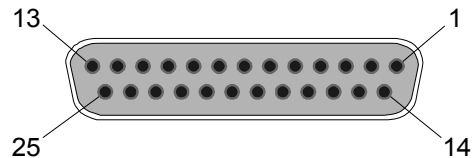

Figure 7: Parallel Port Connector (DSUB 25 female)
(Connector: Compona, 329 156-6)

4.2 SERIAL-1 (J46) AND SERIAL-3 (J35) CONNECTOR

Pin	Signal	Description	Pinout
1	DCD	Carrier detect	
2	RXD	Receive data	
3	TXD	Transmit data	
4	DTR	Data terminal ready	
5	GND	Ground	
6	DSR	Data set ready	
7	RTS	Request to send	
8	CTS	Clear to send	
9	RI	Ring indicator	

Figure 8: Serial Port Connector (DSUB 9 male)
(Connector: Compona, 329 151-6)

4.3 SERIAL-2 (J21) AND SERIAL-4 (J10) CONNECTOR

On a PIP11 with no Serial Port Modules (these are optional), the connectors J10 and J21 are only dummy connectors with no function.

If the PIP11 is equipped with RS232 or RS485 modules on the Serial-2 and Serial-4 port, the RS232 or RS485 signals will be available on connector J10 and J21.

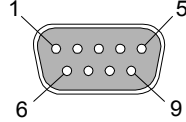
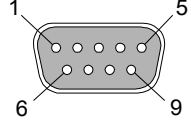
With RS232 Module			Pinout
Pin	Signal	Description	
1	DCD	Carrier detect	
2	RXD	Receive data	
3	TXD	Transmit data	
4	DTR	Data terminal ready	
5	GND	Ground	
6	DSR	Data set ready	
7	RTS	Request to send	
8	CTS	Clear to send	
9	RI	Ring indicator	
With RS485 Module			<p>Figure 9: Serial Port Connector (DSUB 9 male) (Connector: Compona, 329 151-6)</p>
Pin	Signal	Description	
1	NC	Not connected	
2	Rx+	Receive data +	
3	Tx+	Transmit data +	
4	NC	Not connected	
5	GND_isolate	Galvanically isolated Ground	
6	NC	Not connected	
7	Rx-	Receive data -	
8	Tx-	Transmit data -	
9	NC	Not connected	

4.4 EXTERNAL POWER (J1) CONNECTOR

4.4.1 External Power Connector Pin Out

Pin	Signal	Description	Pinout
1	VINCON	Input voltage (8 to 28 V, optional 20 to 48 V)	
2	GNDCON	Power Connector Ground	
3	RST_BTN	Reset Input	
4	PWR_BTN	Power Button Input	

Figure 10: Power Connector (Connector: Phoenix Contact AG, MC1,5/4GF-3,81)

WARNING

**Be aware of the input voltage polarization!
Wrong polarization of the input voltage can cause serious damage to your PIP11!**

4.4.2 Mounting An External Reset And Power Button

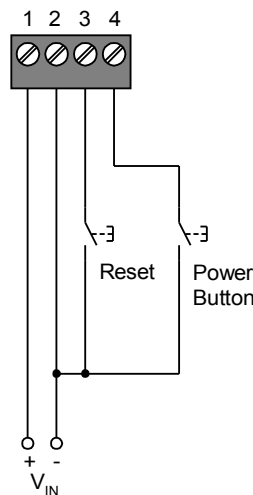

Figure 11: External Reset and Power Button Switch

4.4.3 Power Up Behaviour

Normally if you adapt to VINCON a voltage higher than 8 V your PIP11 will start. If you shut down with the OS functionality you have to start the PIP11 again with a short activation of the Power Button, or you can cycle VINCON.

If you do a Power Button Override (press the Power Button for 4 seconds) the PIP11 will shut down immediately. To start the PIP11 again now, you must press the Power Button for a short time. If you cycle the VINCON voltage, the PIP11 will not start.

4.5 PS/2 KEYBOARD (J8) AND MOUSE (J9) CONNECTORS

Standard PS/2 pinout (6 pin mini-DIN, female). A PC/AT keyboard can also be connected with an adapter.

Pin	Signal	Description	Pinout
1	DAT	Data	
2	NC	Not connected	
3	GND	Ground	
4	VCC	+5 V	
5	CLK	Clock	
6	NC	Not connected	

Figure 12: PS/2 Keyboard & Mouse Connector (Connector: Compona, 129108-7)

4.6 FIREWIRE 1394b (J26, J20, J15) CONNECTORS

Pin	Signal	Description	Pinout
1	TPB-	Twisted Pair B (Minus)	
2	TPB+	Twisted Pair B (Plus)	
3	TPA-	Twisted Pair A (Minus)	
4	TPA+	Twisted Pair A (Plus)	
5	TPA(R)	Twisted Pair A (Reference Ground)	
6	VG	Power (Ground)	
7	NC	Not Connected	
8	VP	Power (Voltage) is equivalent to the input voltage (please refer to the PIP Technical Reference Manual for more information)	
9	TPB (R)	Twisted Pair B (Reference Ground)	

Figure 13: FireWire 1394b bilingual Connector (Connector: Molex, 45241-0001)

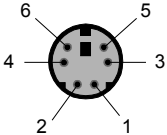
4.7 DUAL USB (J43) CONNECTOR

Pin	Signal	Description	Pinout
1	VCC0	Port 0 Cable Power +5 V	
2	Data0-	Port 0 Balanced Data Line -	
3	Data0+	Port 0 Balanced Data Line +	
4	GND0	Port 0 Cable Ground	
5	VCC1	Port 1 Cable Power +5 V	
6	Data1-	Port 1 Balanced Data Line -	
7	Data1+	Port 1 Balanced Data Line +	
8	GND1	Port 1 Cable Ground	

Figure 14: Dual USB (Type A) Connector (Connector: FCI, 72309-0010B)

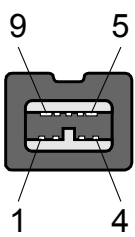
4.8 DVI-I (J30) CONNECTOR

DVI-I Connector with single channel TMDS port and legacy analog port.

Pin	Signal Description	Pinout
1	TMDS Data2-	
2	TMDS Data2+	
3	Shield Data2	
4	NC	
5	NC	
6	DDC Clock	
7	DDC Data	
8	Analog Vertical Sync	
9	TMDS Data1-	
10	TMDS Data1+	
11	Shield Data1	
12	NC	
13	NC	
14	+5 V Power	
15	Ground	
16	Hot Plug Detect	
17	TMDS Data0-	
18	TMDS Data0+	
19	Shield Data0	
20	NC	
21	NC	
22	Shield Clock	
23	TMDS Clock+	
24	TMDS Clock-	
C1	Analog Red	
C2	Analog Green	
C3	Analog Blue	
C4	Analog Horizontal Sync	
C5	Analog Ground	

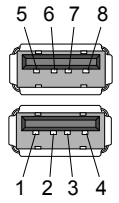
Figure 15: DVI-I Connector (Connector: Samtec, DVI-29-AW-FT)

NOTE:

It is not possible to use CRT and digital monitors in parallel on the DVI port. The DVI-I connector has per definition only one DDC Bus to recognize a monitor. But digital and analog monitors answers to the same DDC bus address on requests. And so if a CRT and a digital monitor is connected to the DVI-I connector (with an Y-cable) there is a mismatch with the monitor information on the DDC bus. Then unpredictable things will be happen.

4.9 10M/100M/1G ETHERNET (J49) CONNECTOR

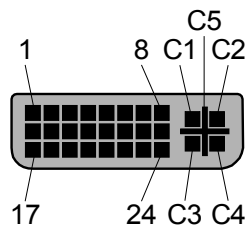
Standard RJ45 connector for a 100 ohm cable.

Pin	Signal	Description	Pinout
1	TD0+	Data 0 +	
2	TD0-	Data 0 -	
3	TD1+	Data 1 +	
4	TD1-	Data 1 -	
5	TD2+	Data 2 +	
6	TD2-	Data 2 -	
7	TD3+	Data 3 +	
8	TD3-	Data 3 -	

Figure 16: RJ45 Connector (Connector: Bel Fuse 0826-1K1T-23)

5.2 PC/AT FUNCTIONALITY

The PIP11 operates as a standard PC/AT with all dedicated registers for

- Timers
- Interrupt controller
- DMA controller
- Real-time clock
- Keyboard controller
- Parallel, serial ports
- IDE controller
- VGA controller

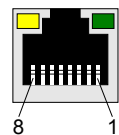
5.3 STATUS INDICATORS

The PIP11 provides eight status indicator LEDs, giving you visual information about the actual operating status.

5.3.1 Power Indicator LED

The power LED indicator lights green if the system has started and is under power. If the System is in Soft Off (S5) mode this LED lights yellow.

If the CPU temperature is above 100°C this LED blinks green/yellow. If the CPU temperature is above 125°C the PIP11 shuts down to Soft Off immediately, and on the next power up this LED blinks green until VINCON is cycled.

5.3.2 Reset Indicator LED

The red reset LED lights if the PIP11 is in reset state. If this LED is blinking the system is in power-fail state. This means the power supply was overloaded or a short circuit has occurred. In this case the power supply switches off to protect itself.

After removing of the overload or the short circuit cause, you can restart the power supply by cycling the power to the PIP or by pushing the Power Button for about 4 seconds until the PIP goes to Soft Off state. Then start the PIP normally by pushing the Power Button again.

5.3.3 HDD Indicator LED

The green HDD access indicator lights whenever an IDE or SATA device is accessed.

5.3.4 IEEE1394b Indicator LED

The yellow FireWire IEEE1394b indicator lights whenever a FireWire device is connected.

5.3.5 LAN ACT Indicator LED

The green LAN indicator lights whenever a link is detected. The LED blinks if network activity is detected.

5.3.6 LAN Spd Indicator LED

The LAN100/1G indicator lights green whenever a 100 MBit/s link is detected and lights yellow when a GBit/s link is detected.

5.3.7 USER1, USER2 Indicator LEDs

The yellow USER1 and USER2 LEDs are programmable, please refer to the PIP11 BIOS User Manual for more information.

5.4 BATTERY CIRCUIT

An on board battery provides power for the data retention of RTC and CMOS RAM in power down situations. The battery can be changed if the battery is empty. Please refer to the PIP Technical Reference Manual for more information.

5.5 HARDWARE WATCHDOG

The PIP11 uses the hardware watchdog implemented in the 6300ESB ICH from Intel. This is a Two-Stage Watchdog with independent count values for each stage. The first stage generates an INT or SMI and the second stage drives the system reset signal active for a system reset. The Watchdog has a configuration option

for write-once enabling and has a configurable granularity from 1 μ s to 10 minutes. For further information please refer to the PIP Technical Reference Manual.

For Microsoft Windows NT, Windows 2000 and Windows XP platforms there is a Watchdog Timer driver available from Intel. This driver provides OS based control of the Watchdog Timer device.

5.6 RS485 / RS422 INTERFACES

If the RS485 / RS422 modules (these are optional) are used as half-duplex interfaces (using a 2-wire connection) it is necessary to control the transmit driver enable. This is done by the UART automatically with the RTS signal. The only thing you have to do, is to select the correct interface type in the BIOS settings (please refer to the PIP11 BIOS User Manual).

6 SOFTWARE

6.1 BIOS

BIOS upgrading with an additional utility is easily possible. Please refer to the PIP11 BIOS User Manual for additional BIOS information.

6.2 DEVICE DRIVERS

The drivers can be found on the MPL AG homepage at www.mpl.ch/t2400.html. But the latest driver versions are always available on the internet:

- Texas Instruments TSB82AA2 1394b FireWire Controller:

No special driver is need, because the standard Operating System FireWire OHCI driver will work for this controller.

For Microsoft Windows specific 1394b behavior, please have a look at the Microsoft homepage, especially at the KB885222 article.

- Intel 82541ER GBit Ethernet Controller:

http://downloadfinder.intel.com/scripts-df-external/Product_Filter.aspx?ProductID=1635

- Intel 82541PI GBit Ethernet Controller:

http://downloadfinder.intel.com/scripts-df-external/Product_Filter.aspx?ProductID=1938

- Intel 82855 GMCH with IGD (Integrated Graphics Device):

http://downloadfinder.intel.com/scripts-df/Product_Filter.asp?ProductID=939

- Intel 6300ESB ICH with Watchdog

http://downloadfinder.intel.com/scripts-df/Product_Filter.asp?ProductID=1706

Note:

- Links might have changed.

This page intentionally left blank.

This page intentionally left blank.

7 COPYRIGHT

Copyright © 2007 by MPL AG Elektronikunternehmen. All rights are reserved. Reproduction of this document in part or whole, by any means is prohibited, without written permission from MPL AG Elektronikunternehmen.

8 DISCLAIMER

MPL AG has fully tested the PIP11 and reviewed the documentation. However, MPL AG makes no warranty or representation, either expressed, or implied, with respect to this product, its quality, performance, merchantability, or fitness for a particular purpose.

In no event will MPL AG be liable for direct, indirect, special, incidental, or consequential damages resulting from any defect in the product or its documentation, even if advised of the possibility of such damages. In particular MPL AG shall have no liability for any parts connected to this product.

MPL AG reserves the right to make changes to any product herein to improve reliability, function or design.

9 TRADEMARKS

Brand or product names are trademarks and registered trademarks of their respective holders.

10 SUPPORT

10.1 FAQ

Please have a look at our homepage www.mpl.ch/t2400.html. In the menu at the left hand side you will find FAQ's for each PIP.

10.2 SERIAL NUMBER AND REVISION

For support it is necessary that you know the product name, the product variant, the serial number and the BIOS number of your PIP11. Please have a look at the label on the bottom of the PIP11 housing for this.

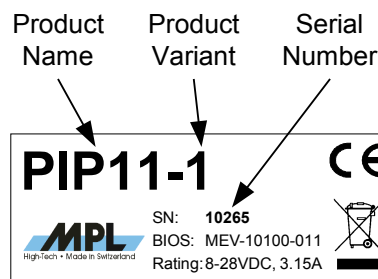

Figure 18: PIP11 Label

10.3 CONTACT MPL AG

In case of general information questions please feel free to contact us at our homepage (www.mpl.ch) or per email (info@mpl.ch).

In case of sales information questions please send an email to sales@mpl.ch.

If you have a technical problem with a PIP11, first please read the BIOS User Manual, the Technical Reference Manual and also this manual carefully. If you can't solve the Problem on your own you can contact us for technical support per email at support@mpl.ch.

Our local Distributor: