

IVC-8371P
4 Channel MPEG-4 Video & Audio Capture Card

User Manual

Version 1.0 December 2005

Revision History

Title	IVC-8371P 4 Channel MPEG-4 Video & Audio Capture Card	
Revision Number	Description	Date of Issue
1.0	Initial release	December 2005

Copyright Notice

The information in this document is subject to change without prior notice in order to improve reliability, design and function and does not represent a commitment on the part of the manufacturer.

In no event will the manufacturer be liable for direct, indirect, special, incidental, or consequential damages arising out of the use or inability to use the product or documentation, even if advised of the possibility of such damages.

This document contains proprietary information protected by copyright. All rights are reserved. No part of this manual may be reproduced by any mechanical, electronic, or other means in any form without prior written permission of the manufacturer.

Trademarks

IEI is registered trademark of IEI Technology Corp or its subsidiaries worldwide. IBM PC is a registered trademark of International Business Machines Corporation. INTEL is a registered trademark of INTEL Corporation. AMI is registered trademarks of American Megatrends Inc. Other names or brands may be claimed as the property of others.

If you have any questions or need other information, please visit our web site at <http://www.ieiworld.com/>

Table of Contents

1. Introduction.....	8
1.1. General Information	8
1.2. Product Specification.....	9
1.3. Package Content.....	10
1.4. System Requirement.....	10
1.5. Dimensions.....	11
2. Installation.....	13
2.1. Hardware Installation	13
2.1.1. Installing IVC-8371P.....	13
2.1.2. Installing GPIO Module	16
2.2. Driver Installation.....	17
2.3. Verify Installation	20
2.4. FFDSHOW Video CODEC Installation	21
2.5. Run Demo Program	22
3. Demo Program.....	24
3.1. Menu.....	24
3.1.1. File Menu.....	24
3.1.2. Encoder	25
3.1.3. Decoder.....	25
3.1.4. View	25
3.1.5. Motion Detection Menu	26
3.1.6. GPIO	27
3.1.7. Help	28
3.2. Toolbar.....	29
3.3. Video Area	30
3.4. System Log Window	30
3.5. Encode / Decode Info Window.....	31

3.6. Playback Control 32

4. Encoding & Decoding 34

4.1. Encoding Start and Stop 34

4.2. Decoding Start and Stop 35

5. Configuration Dialog 37

5.1. Encoder Parameters Tab 37

5.1.1. Global Parameters 38

5.1.2. Encoder Parameters 38

5.2. Decoder Parameters 40

5.2.1. Device Selection..... 41

5.2.2. Video Parameters..... 41

5.2.3. Audio Parameters 41

5.3. Set Video Decoder 42

5.3.1. Device Selection..... 43

5.3.2. Set Video Decoder Controller 43

5.4. Set Motion Detection 44

5.4.1. Device Selection..... 45

5.4.2. Set Motion Detection Parameters 45

Safety Notice

Electrical shock hazards might occur while proceeding with the installation, repair and maintenance of this product. Therefore, the following precaution measures should be carefully observed:

1. All sorts of operations on this product must be carried out by certified technicians.
2. The chassis into which the CPU board and its associated backplane are installed should provide stable power supply and be properly grounded.
3. Power off the CPU board and unplug its power cord before handling.
4. When handling the CPU board, avoid touching any metal leads or connectors.
5. Please verify that the power supply is switched off before unplugging the power supply connector from the CPU board.

ESD Precautions

Observe all conventional anti-ESD methods while handling the CPU board. The use of a grounded wrist strap and an anti-static work pad is recommended. Avoid dust and debris or other static-accumulating materials in your work area.

Conventions Used in This Manual



WARNING

Warnings appear where overlooked details may cause damage to the equipment or result in personal injury. Warnings should be taken seriously. Warnings are easy to recognize. The word “warning” is written as “**WARNING**,” both capitalized and bold and is followed by text in italics. The italicized text is the warning message.



CAUTION

Cautionary messages should also be heeded to help you reduce the chance of losing data or damaging the system. Cautions are easy to recognize. The word “caution” is written as “**CAUTION**,” both capitalized and bold and is followed by text in italics. The italicized text is the cautionary message.

**NOTE**

These messages inform the reader of essential but non-critical information. These messages should be read carefully as any directions or instructions contained therein can help you avoid making mistakes. Notes are easy to recognize. The word “note” is written as **NOTE**, both capitalized and bold and is followed by text in italics. The italicized text is the cautionary message.

Chapter

1

Introduction

1. Introduction

1.1. General Information

IVC-8371P is a 4-channel Video/Audio capture card provides multi-standard video output including MPEG4/H.263/MPEG-2 and MPEG-1. Empower by its high performance MPEG-4 CODEC chip, IVC-8371P can encode and display video/audio simultaneously in real time.

Unlike most video capture cards in market, IVC-8371P's hardware CODEC solution requires much lower CPU resource consumption than those adapting pure software compression or hardware /software compression. This remarkable feature makes IVC-8371P the ideal solution for multi-channel application and POS/ATM system integration.

With our leading-edge technology and professionalism in industrial computing, IVC-8371P is designed with high stability and functionality to fulfill your need.

1.2. Product Specification

Interface

Video input	4 channel NTSC/PAL/SECAM
Video input type	BNC
Audio Input	4 channel
Audio input type	Audio cable, DB9 to 3.5mm phone jack
PCI interface	PCI v2.1 compliance
Card ID	Dip-switch selectable

Video Processing

Video Compression	MPEG-4 Advanced Simple Profile @ Level 5(ISO/IEC 14496-2) MPEG-2 Main Profile @ Main Level (ISO/IEC 13818-2) MPEG-1 (ISO/IEC 11172-2)
Resolution & frame rate	720×480(576) @ 1~30(25) fps 720×240(288) @ 1~60(50) fps 360×240(288) @ 1~120(100) fps

Audio Processing

Audio Compression	Encoding Standard G.726 (ADPCM/PCM)
Sampling Rate	8K, 44.1 KHz and 48 KHz
Quantization	8 bit data depth

Functionality

Video /audio synchronization	Yes
On-screen display	Yes
Camera loss detection	Yes
Motion detection	Hardware support
Watermarking	128 bit secrete key, adjustable length

Software Support

Device Driver	Provide driver for Window 2000/ XP
SDK	Provide SDK and demo program for software application development.

Operation environment

Dimension	119.91x 106.68mm
Operation Temperature	0~60°C (32~140°F), non-condensing
Power Consumption	7.5W

1.3. Package Content

- A. IVC-8371P x 1pcs
- B. DB9 to 3.5mm phone jack audio cable x 1pcs
- C. Companion CD x1pcs
- D. Quick Installation Guide x 1pcs



A



B



C



D

1.4. System Requirement

- IBM or IBM compatible computer
- For single IVC 8371P:
 - Pentium 3,1.0GHz CPU
- For more than one IVC 8371P:
 - Pentium 4,2.0 GHz CPU, or better processor for reasonable display quality
- Minimum 256MB memory
- AGP compatible Super VGA video card supporting DirectX and Video Overlay function
- At least one unoccupied PCI slot and IRQ
- Microsoft DirectX 9.0b (or above version) installed
- OS: Windows 2000 or Windows XP

1.5. Dimensions

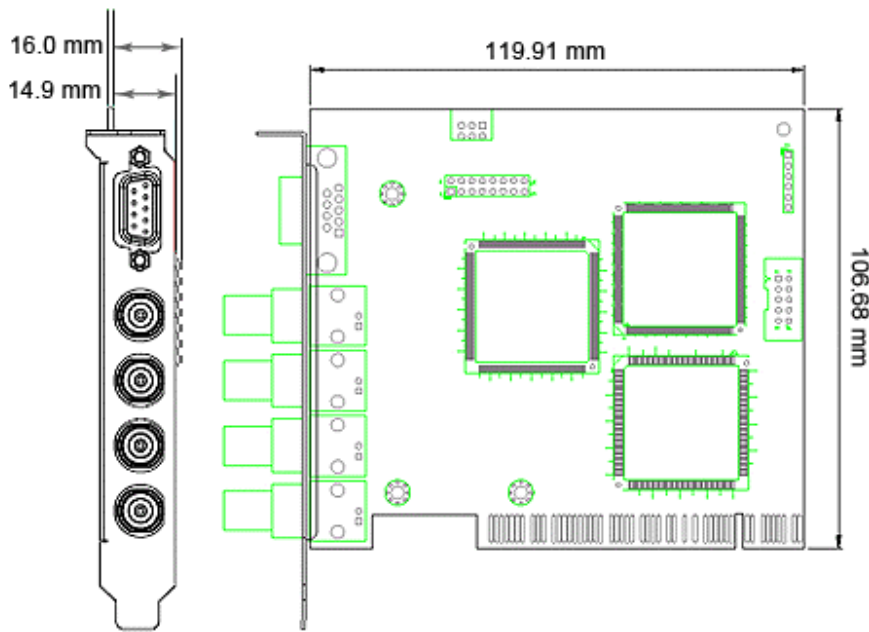

Chapter

2

Installation

2. Installation

2.1. Hardware Installation

2.1.1. Installing IVC-8371P

1. Power off the computer and remove the external power cord from the computer. Remove the chassis cover.

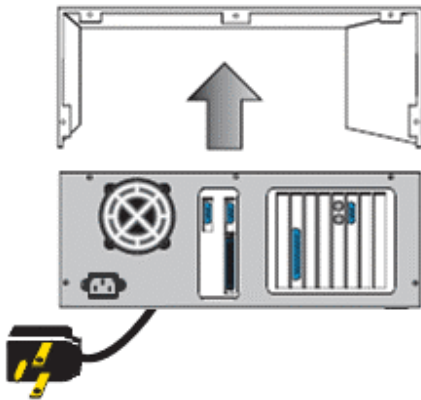

2. Locate an unoccupied PCI expansion slot on the main board/ backplane.



3. Position the IVC-8371P over the PCI slot and gently plug the card in the expansion slot.

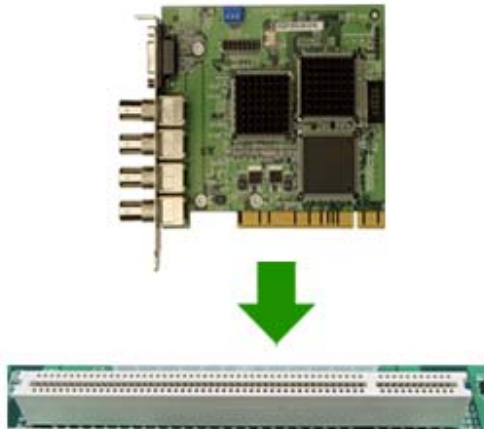

4. If the IVC-8371P installed on step 4 is supposed to work with a GPIO module, please install the GPIO module at this step. Please refer to 3.1.2. Installing GPIO Module.
5. Fasten the mounting bracket of IVC-8371P to the chassis.
6. If you are installing more that one IVC-8371P at a time, please repeat step 2 tp 6.



NOTE:

Make sure that every IVC-8371P on the same system has different ID. You can change the card ID by adjusting the DIP switch on board.



7. Put the cover back to the chassis.
8. Connect the audio cable to the IVC-8371P. Each 3.5mm phone jet input maps to a specific video channel. There is channel number indicator located near each 3.5mm phone jet of the audio cable. The channel number of the video input is shown in the

picture below.



9. Connect the video source to the BNC connector of IVC-8371P. Then connect the audio source to the audio cable.

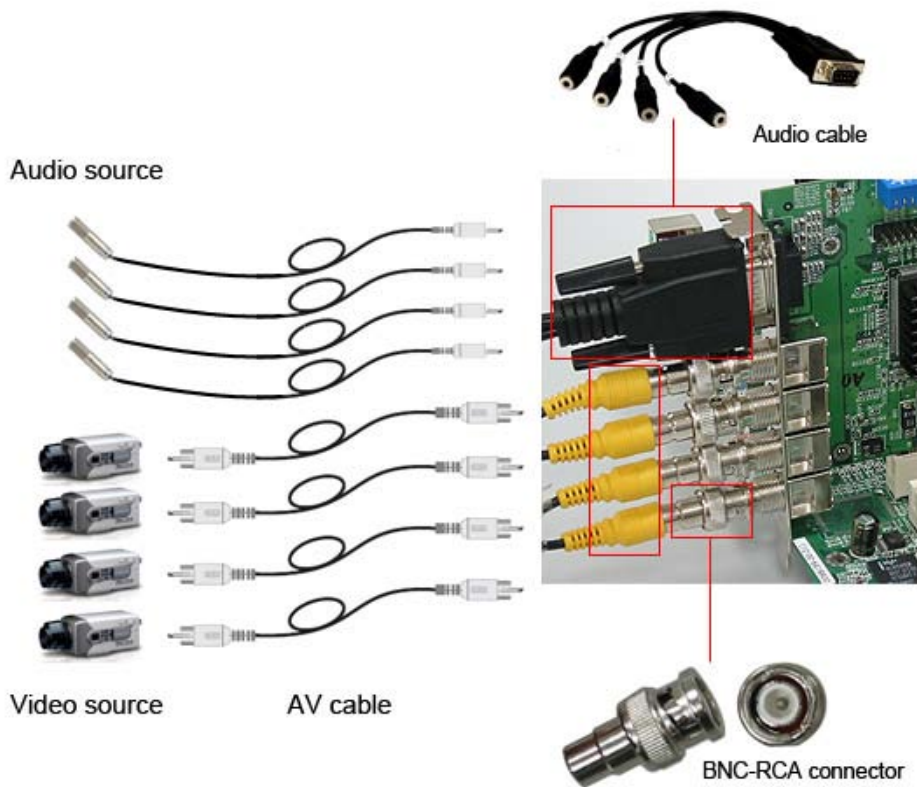

NOTE:

Adapting four IVC-8371P cards to a system with Pentium 4 2.0GHz CPU to concurrently have been tested. Attaching more than 4 IVC-8371P cards to the same system is not tested and not recommended.

2.1.2. Installing GPIO Module

The GPIO module contains a GPIO daughter board, an input connector and an output connector. The GPIO module allows users to connect four input devices and four output devices. Please refer to Figure below.

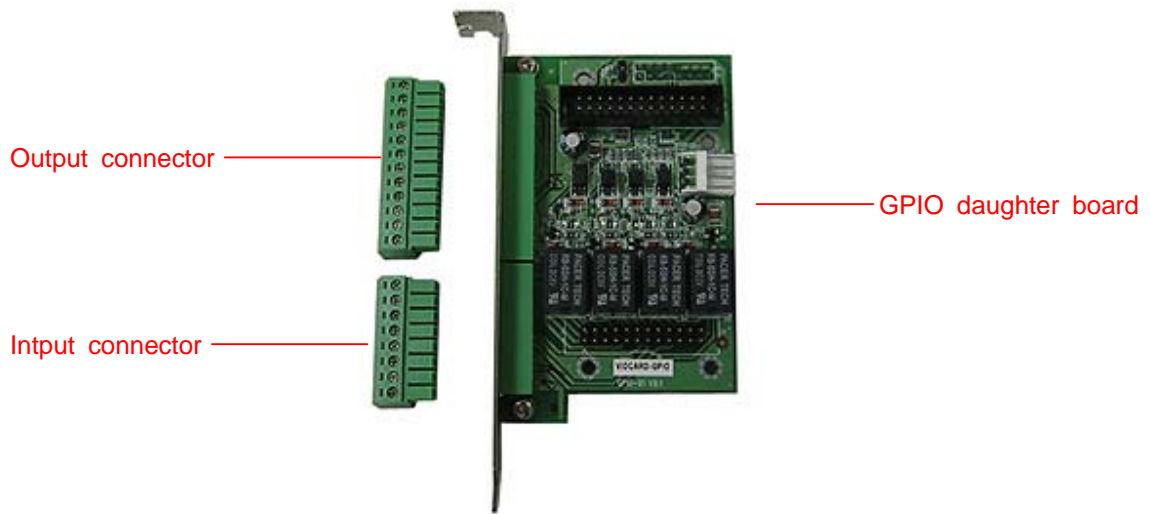

Connecting GPIO Module to IVC-8371P

1. Remove the output connector and input connector from the GPIO daughter board.
2. Connect the GPIO daughter board to IVC-8371P as shown below:

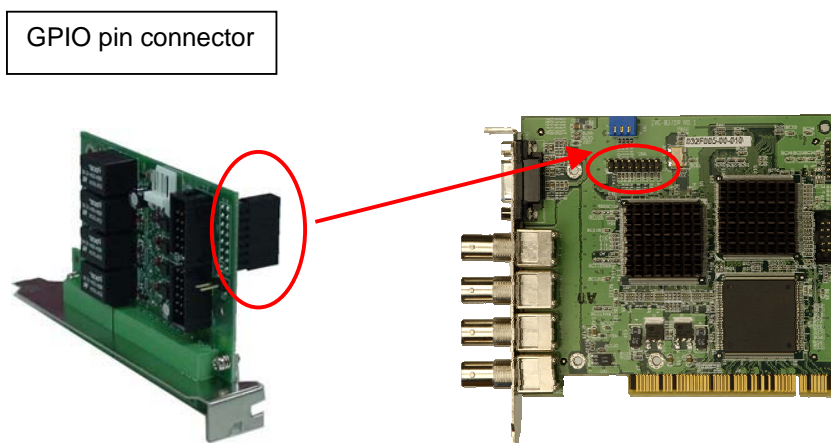

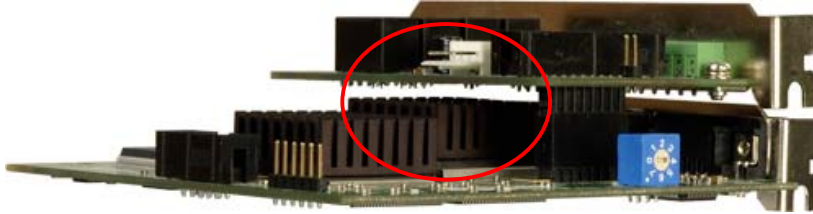

For the detail about pin definition of GPIO , please refer to Appendix A.

2.2. Driver Installation

1. After you have installed IVC-8371P card on your computer, turn on the power.
2. Run the product utilities CD. Select “Install Device Driver”.

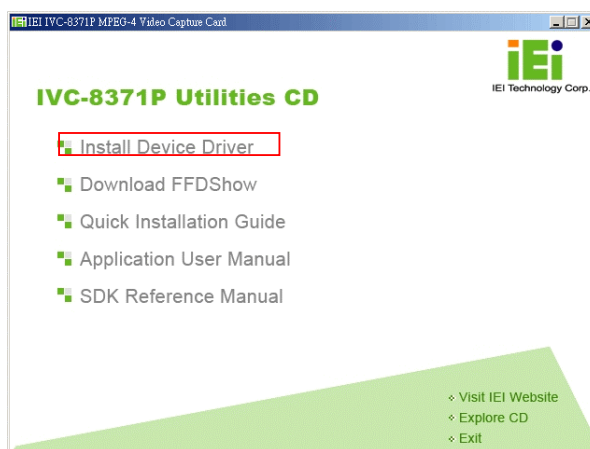

3. Follow the instructions and start the installation.

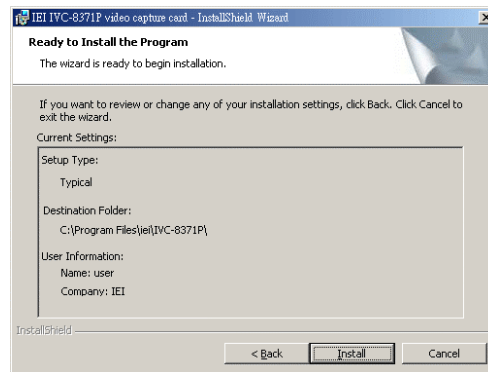
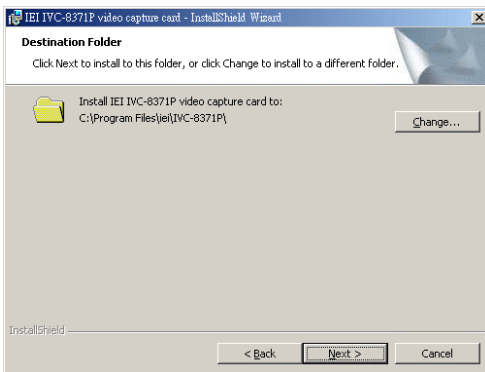
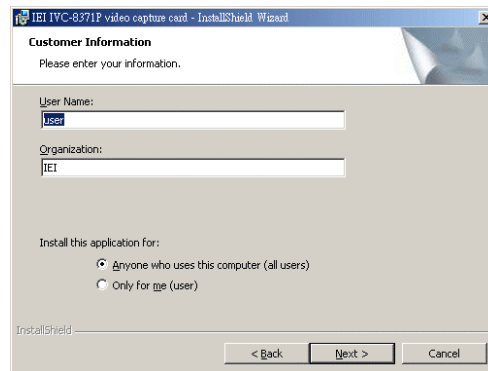
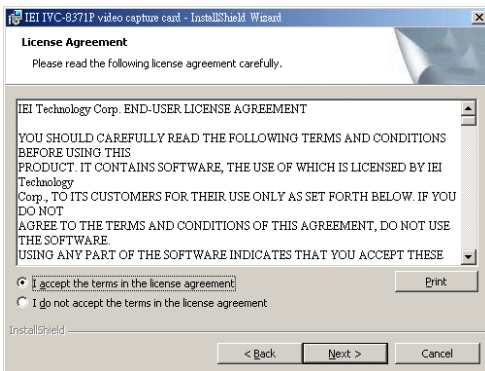
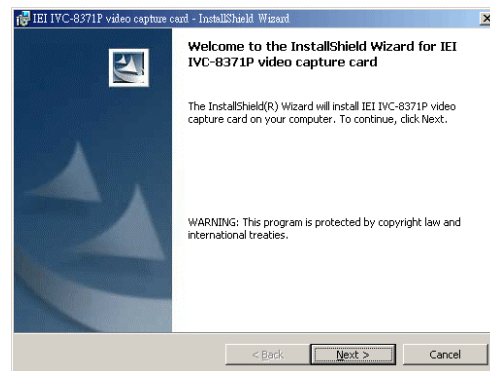
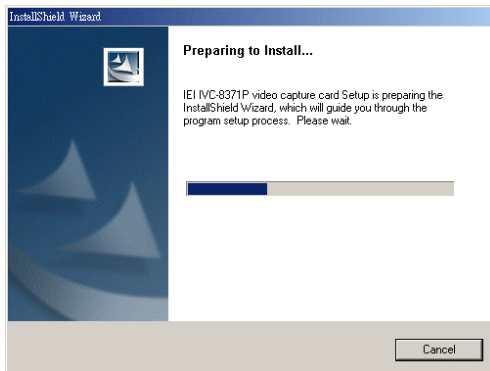

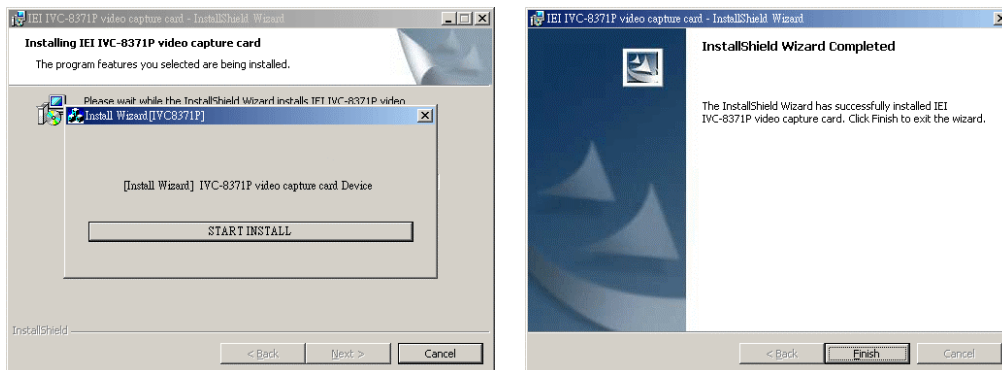

4. After driver installation completed, please reboot your computer.



NOTE:

To add a new card to the system after first installation, you have to:

- 1. Uninstall the previous installed driver.*
- 2. Plug the new card to the system.*
- 3. Install the device driver again.*

Uninstalling the old driver is also required before driver upgrade.

2.3. Verify Installation

After the driver has been installed successfully, you will see IVC-8371P listed in the device manager.

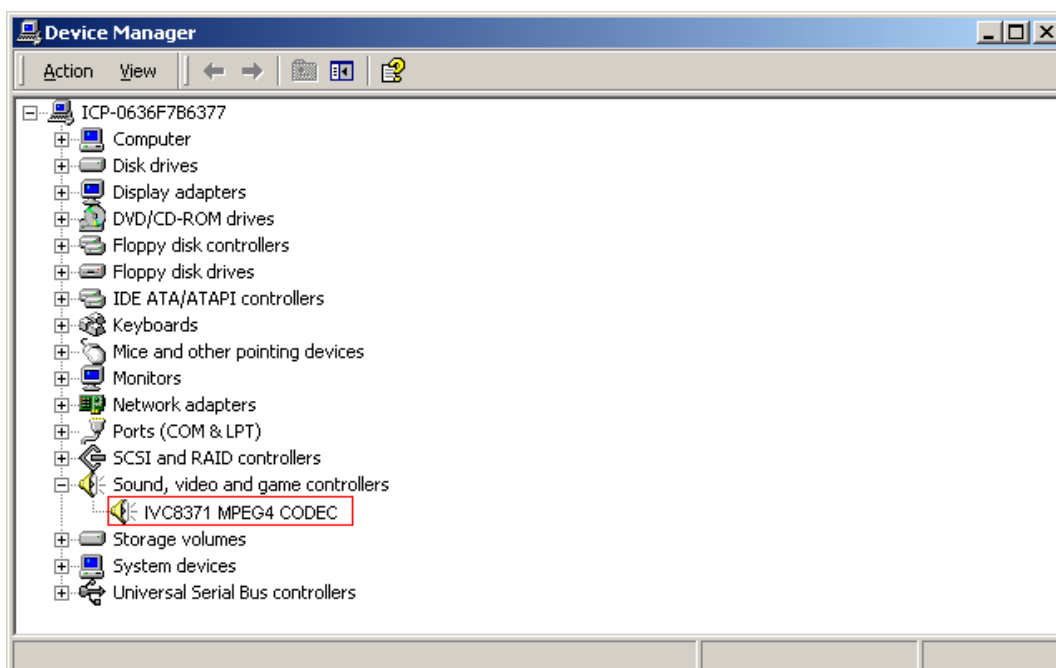

2.4. FFDSHOW Video CODEC Installation

FFDSHOW video codec must be installed to the system before using IVC-8371P. FFDSHOW is DirectShow and VFW codec for decoding/encoding many video and audio formats, including DivX and XviD movies using libavcodec, xvid and other open-source libraries with a rich set of post-processing filters.

FFDSHOW is a freeware and can be downloaded at the FFDSHOW official website:
<http://sourceforge.net/projects/ffdshow>

After downloading the FFDSHOW CODEC, run ffdshow.exe.



Follow the installation guide and the wizard will complete installation process.

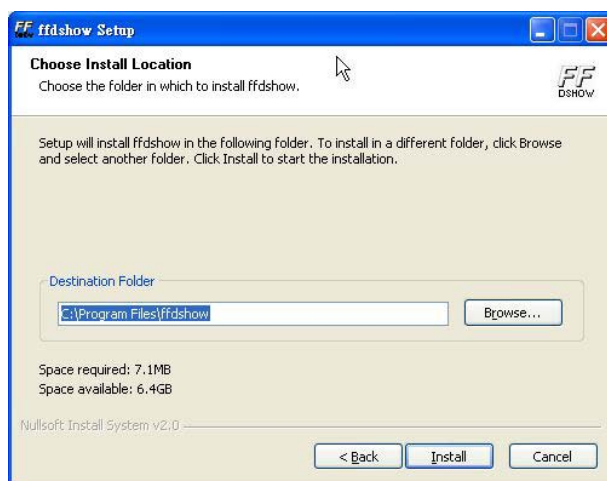
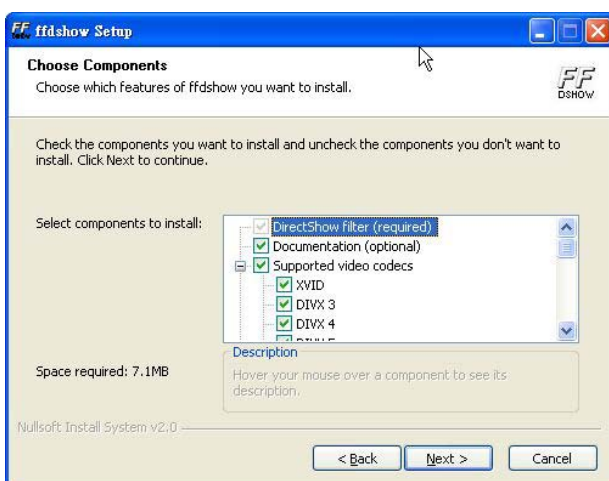

2.5. Run Demo Program

Run the demo program at Start→Programs→IEI→IVC-8371P →IVC-8371 demo program

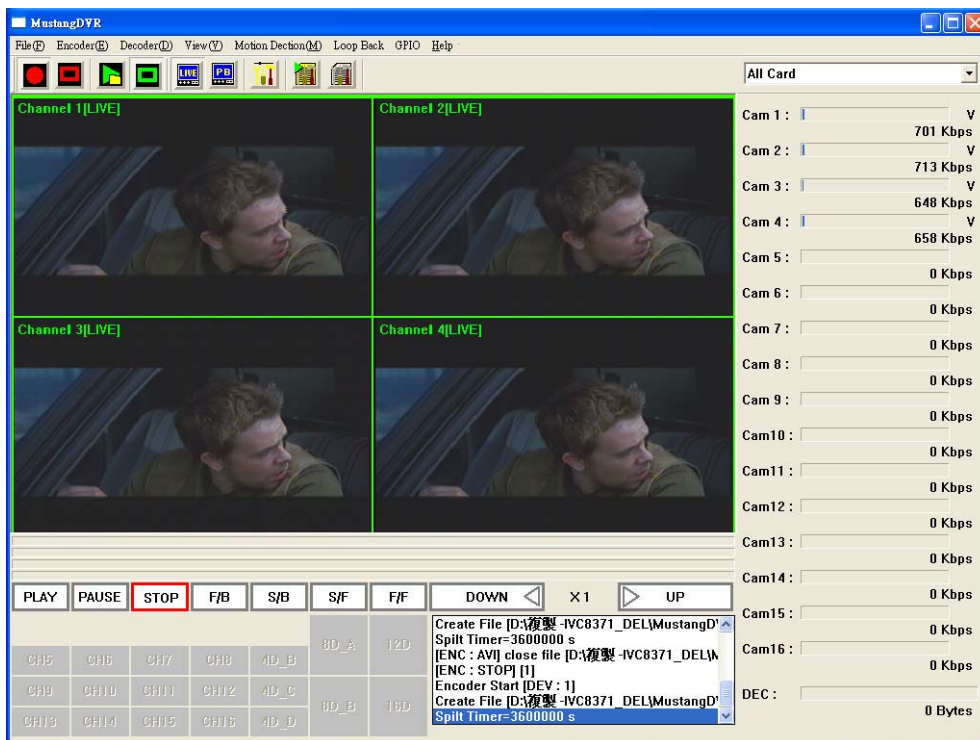
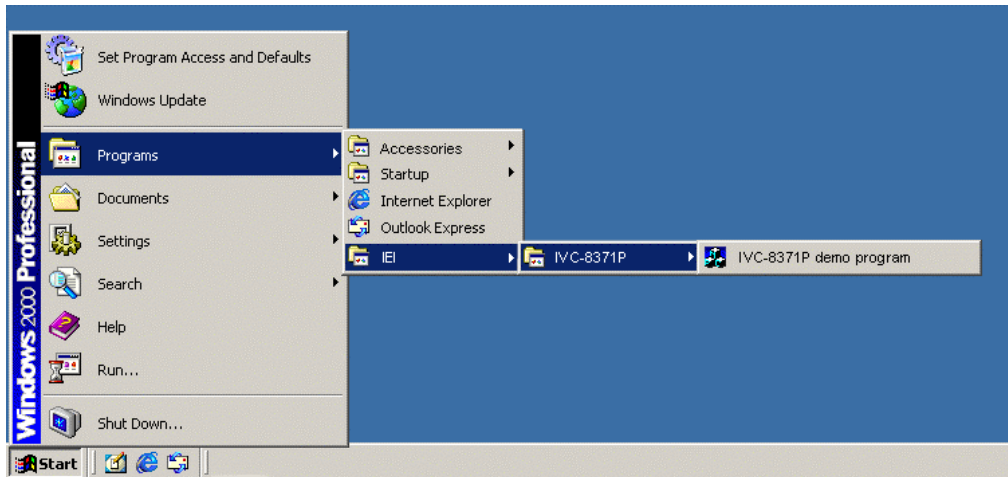

User interface of IVC-8371P demo application

Chapter

3

Demo Program

3. Demo Program

The user interface of demo program can be divided into seven functional areas.

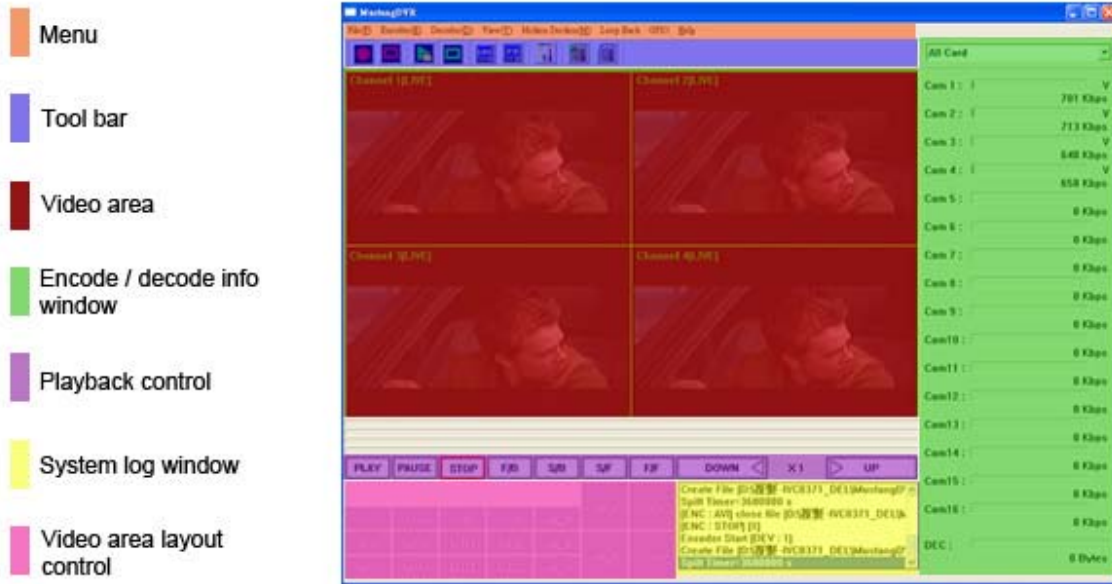

3.1. Menu

File(F) Encoder(E) Decoder(D) View(V) Motion Dection(M) Loop Back GPIO Help

3.1.1. File Menu

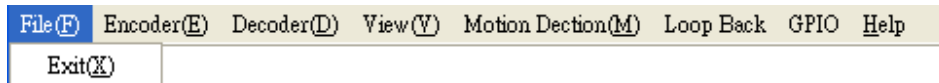

Exit : terminate the demo program.

3.1.2. Encoder

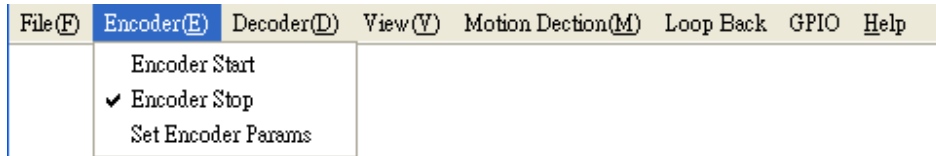

Encoder Start : Start recording.

Encoder Stop : Stop recording.

3.1.3. Decoder

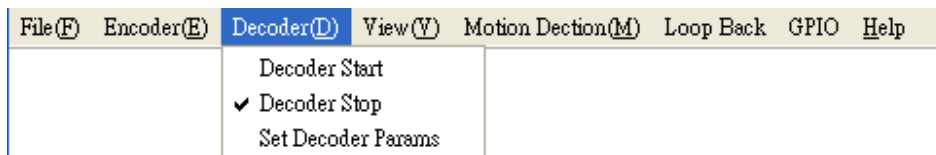

Decoder Start : Start displaying the recorded video.

Decoder Stop : Stop displaying the recorded video.

3.1.4. View

The view menu controls the layout of the program UI. Functional windows or video display layout can be active or change by checking the corresponding item of the view menu.

3.1.5. Motion Detection Menu

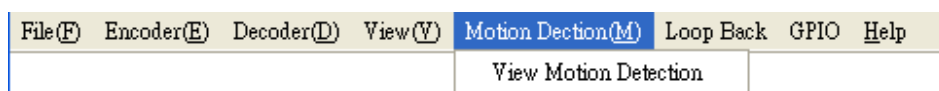

Check the “View Motion Detection” item to configure the active area of motion detection on the video area.

3.1.6. GPIO

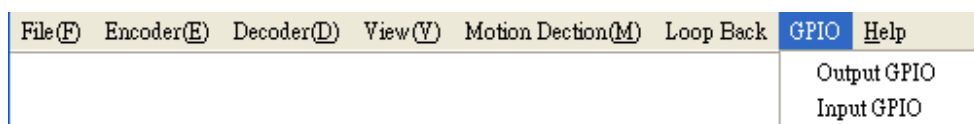

Output GPIO: send signal to GP output.

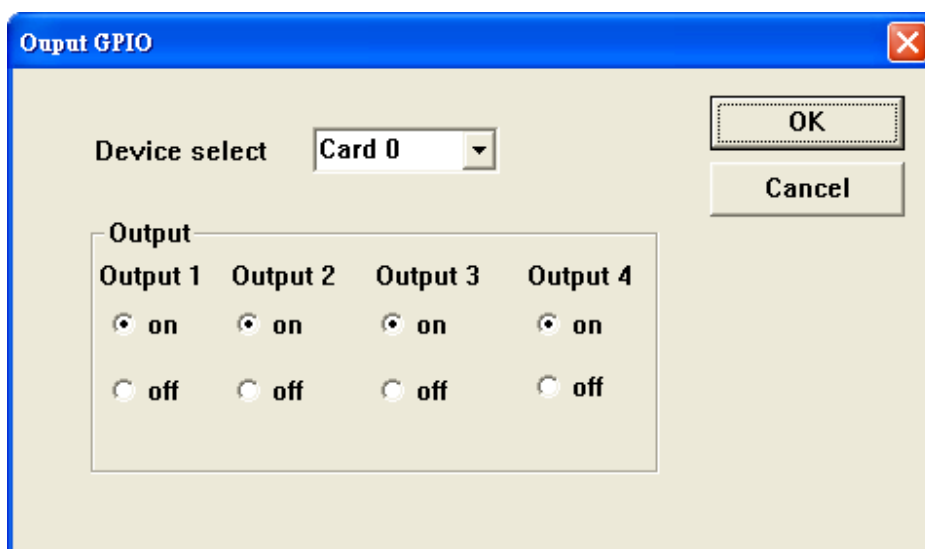

Device select : Selection device card.

Output 1: define the signal (on/off) to be sent to output 1.

Output 2: define the signal (on/off) to be sent to output 2.

Output 3: define the signal (on/off) to be sent to output 3.

Output 4: define the signal (on/off) to be sent to output 1.

Input GPIO: read signal from GP input.

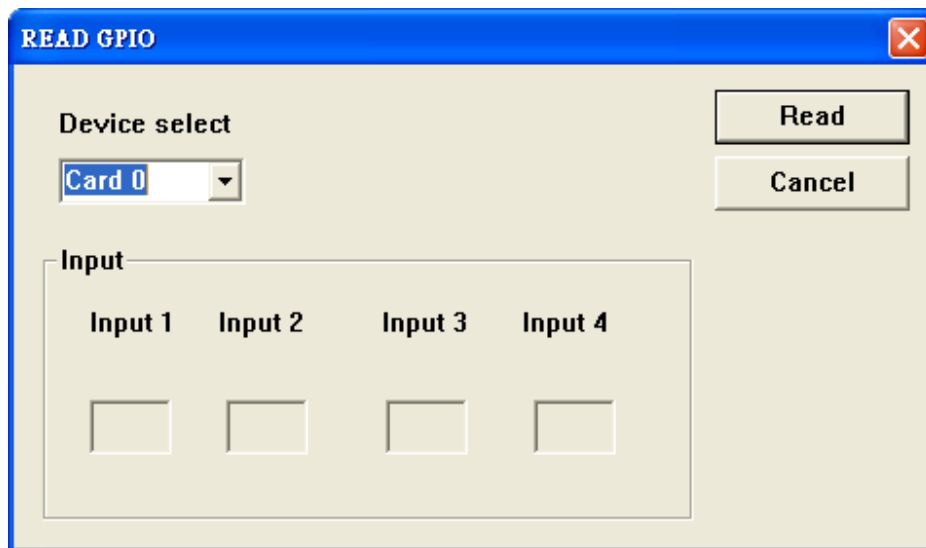

Device select : Selection the card ID to be read.

Input: the value read from the GP input will be shown here after pressing the Read button.

3.1.7. Help

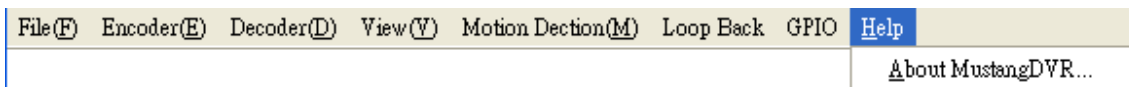







About : Display company information and application version.





3.2. Toolbar



Toolbar includes the frequently used function of demo program. These functions are divided into five sets.

- | | | | | |
|----|--|--|--|--|
| A. |  Start encoding | B. |  Start decoding | |
| |  Stop encoding | |  Stop decoding | |
| | C. |  Display live video | D. |  Configuration dialog |
| | |  Display playback video | | |

- E.  Set Immediate Parameters
-  Load configuration file

Most of the function parameter configurations such as encoding format, frame rate and motion detection, etc. are under Configuration dialog. The detail about Configuration dialog will be presented at Chapter 5.

3.3. Video Area

Live monitoring or playback video will be displayed on video area. There are seven layout options available.

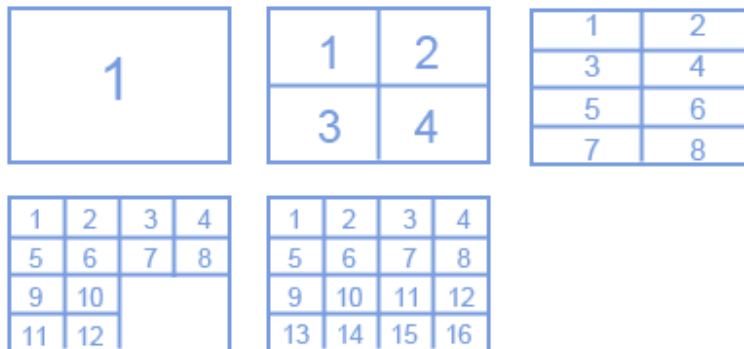

3.4. System Log Window

The system log window shows the encoding file size and board operate information.

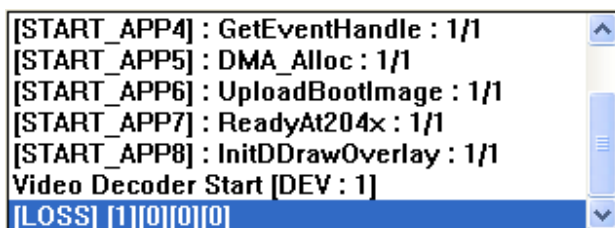

Operation information such as initialization procedure and board operation status information is displayed in the text box.

3.5. Encode / Decode Info Window

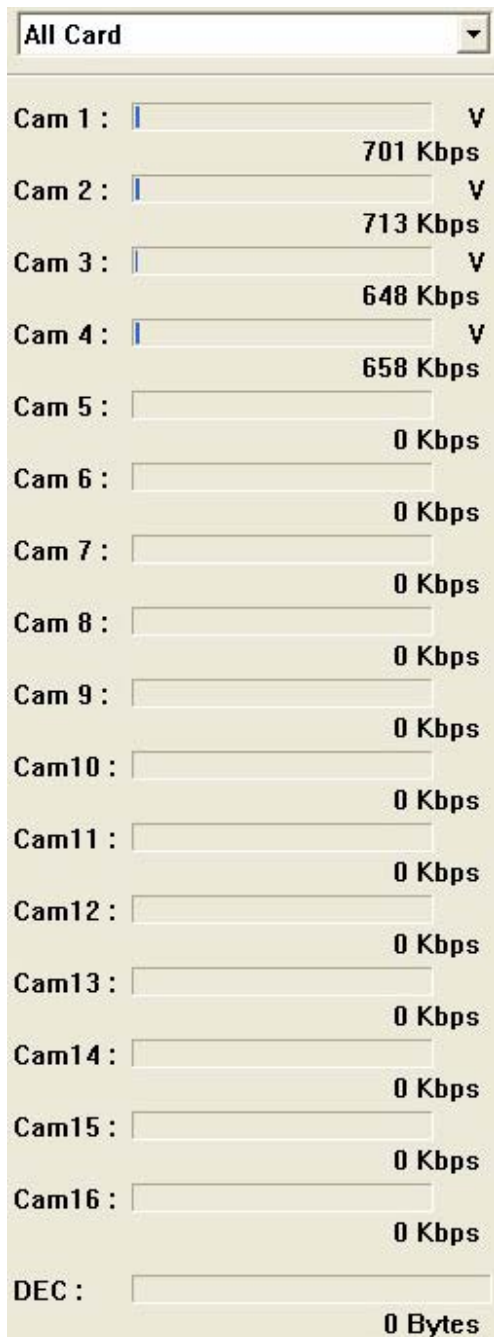

This progress bar shows recording file size as Kbps. The file size is average value of the latest 100 frames.

3.6. Playback Control



Notice: Only PS file can be played by the demo program.

PLAY : Play PS file.

PAUSE: Pause PS file proceed.

STOP: Stop playing PS file.

F/B: Fast rewind.

S/B: Slow rewind.

S/F: Slow forward.

F/F: Fast forward.

Down: Decrease play speed magnification.

UP: Increase play speed magnification.

Chapter

4

Encoding & Decoding

4. Encoding & Decoding

4.1. Encoding Start and Stop

To encode video and audio, follow the procedures below:

1. Set encoder parameter on the configuration dialog.
2. Click  in the toolbars to start encode.

The recorded file will be stored in the same folder as the application program file as default, or specify in the configuration dialog. The naming rule of the recorded file is demonstrated as following:

YYYYMMDD_HHMMSS_FRC.m4v

YYYY : Year
MM : Month
DD : Day
HH : Hour
MM : Min
SS : Second
F : Video format N=NTSC, P=PAL
R : Resolution D=D1, H=half D1, C=CIF
C : Channel S=Single channel, M=Multi channel

Example: 20040701_132230_NDM.m4v

The example file is a mutli-channel video file recorded at 1:22.30PM on July 7, 2004. 7. 1, NTSC input with D1 resolution.

To stop encode, click  in the toolbar.

4.2. Decoding Start and Stop

To decode the encoded video file, follow the procedures below:

1. Click Set display window to playback.
2. Set decoding parameters on the configuration dialog.
3. Click  in the toolbar then select the encoded video file to be decoded.

To stop decoding, click  in the toolbars

Chapter

5

Configuration Dialog

5. Configuration Dialog

5.1. Encoder Parameters Tab

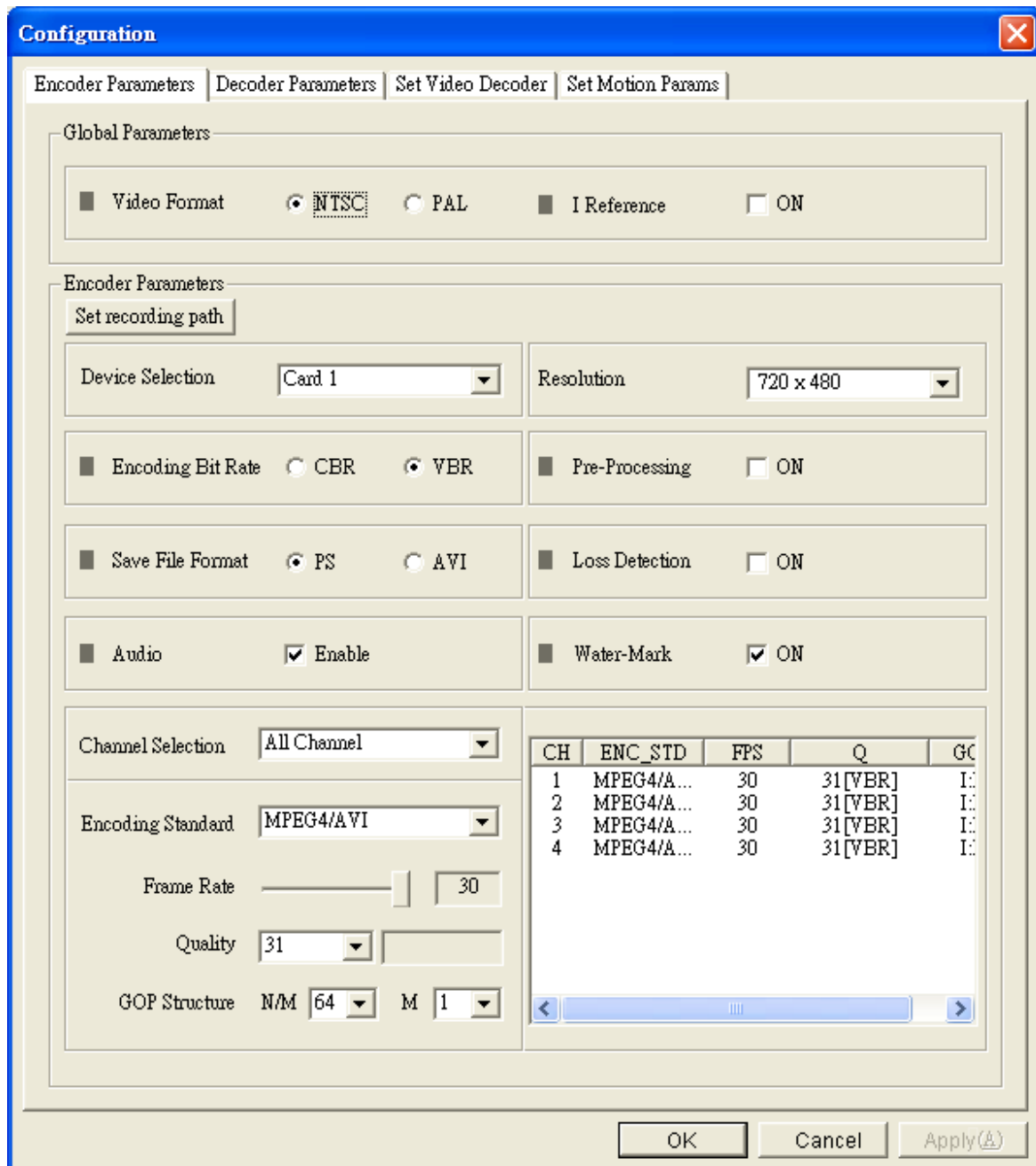

5.1.1. Global Parameters

Video Format : Choose the input video system (PAL/NTSC).

I Reference : on/off

***Notice:** Global parameters will be applied to IVC-8371P on the same system.

5.1.2. Encoder Parameters

Device Selection : Select the target card to be configured

Resolution : Configure video size.

Options table for NTSC

Resolution Options	Total Maximum Frame Rate
720x480	30 fps
720X240	60fps
360X240	120fps
640x480	30 fps
640x240	60 fps
320x240	120 fps

Options table for PAL

Resolution Options	Total Maximum Frame Rate
720x576	25 fps
720X288	50fps
360X288	100fps
640x576	25 fps
640x288	50 fps
320x288	100 fps

Encoding Bit Rate : CBR(Constant Bit Rate) or VBR(Variable Bit Rate)

Pre-Processing : enable or disable

Save File Format : PS or AVI

Loss Detection : enable or disable

Audio : encode with audio (enable or disable)

Water-Mark : add watermark bit into video stream(enable or disable)

Channel Selection : Select the target channel of the selected device to be configured

Encoding Standard : MPEG1, MPEG2, H.263 or MPEG4

Frame Rate : Set the frame rate of decoding video

Quality : Set the quantizer value

GOP Structure : Set the GOP structure by setting N/M and M value

Set Recording Path : select the directory which encoded file will be saved to.

Click the  button to save the configuration.

5.2. Decoder Parameters

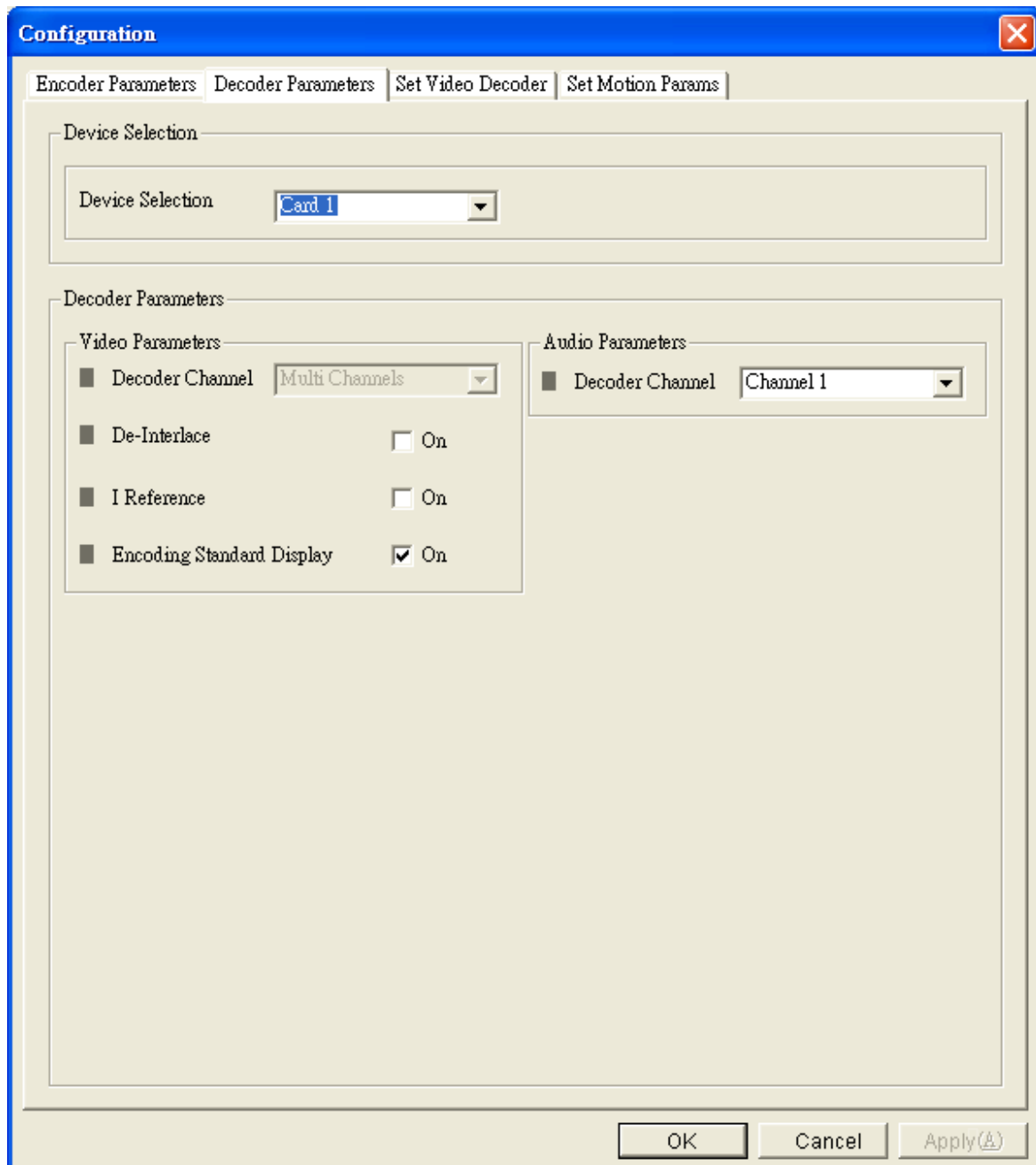

5.2.1. Device Selection

Select the target device to be configured

5.2.2. Video Parameters

Decoding Channel : Default Multi Channel.

De-interlace : Enable de-interlace.

I Reference : Enable I Reference.

Encoding Standard Display : Enable Standard Display.

5.2.3. Audio Parameters

Decoding Channel : Select the channel to be decoded.

Click the  button to save the configuration.

5.3. Set Video Decoder

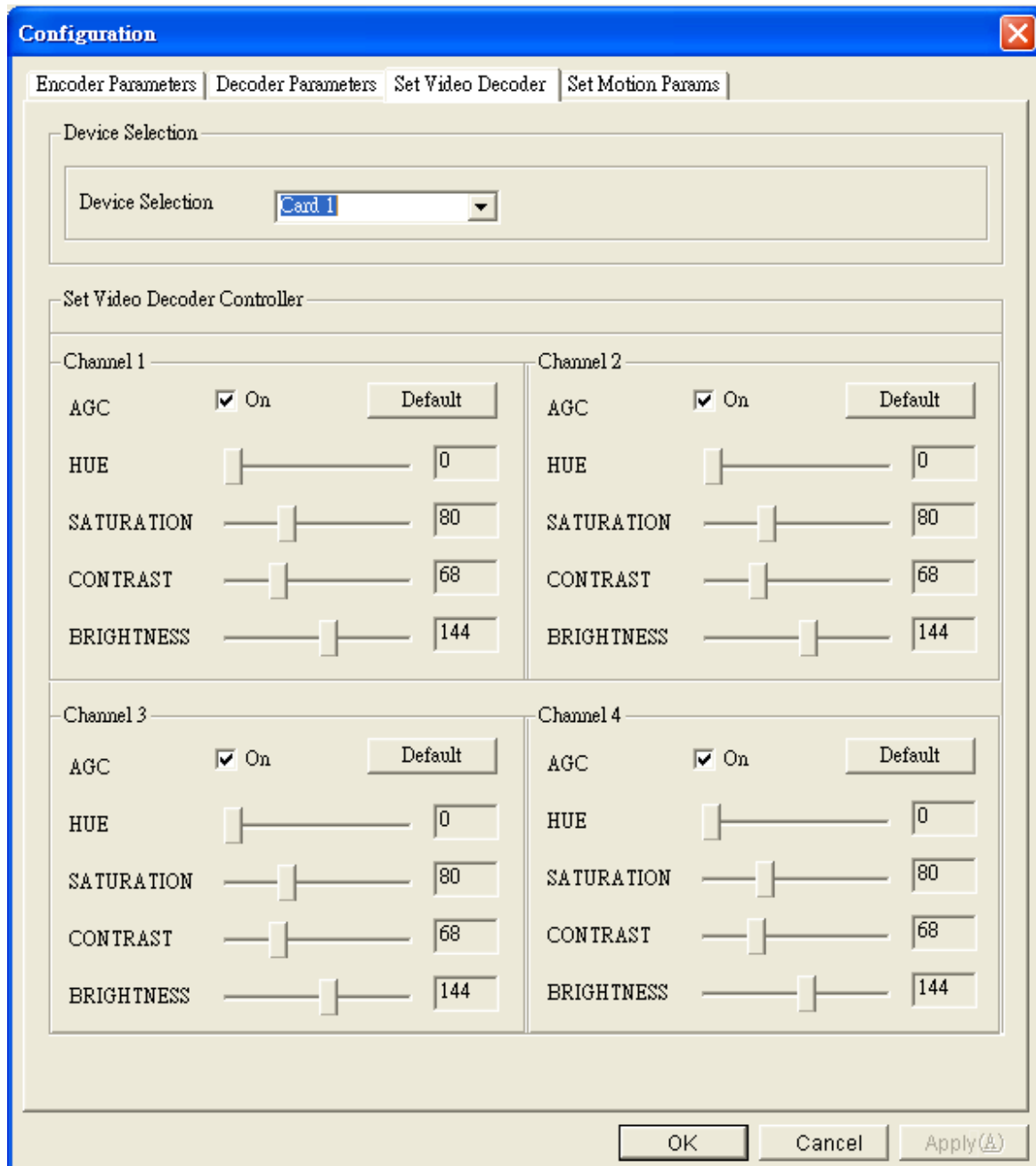

5.3.1. Device Selection

Device Selection : Select the target device to be configured

5.3.2. Set Video Decoder Controller

AGC, Hue, Saturation, Contrast and Brightness can be configured for each channel respectively.

Default value:

AGC = on,

HUE = 0,

SATURATION = 80,

CONTRAST = 68,

BRIGHTNESS = 144

5.4. Set Motion Detection

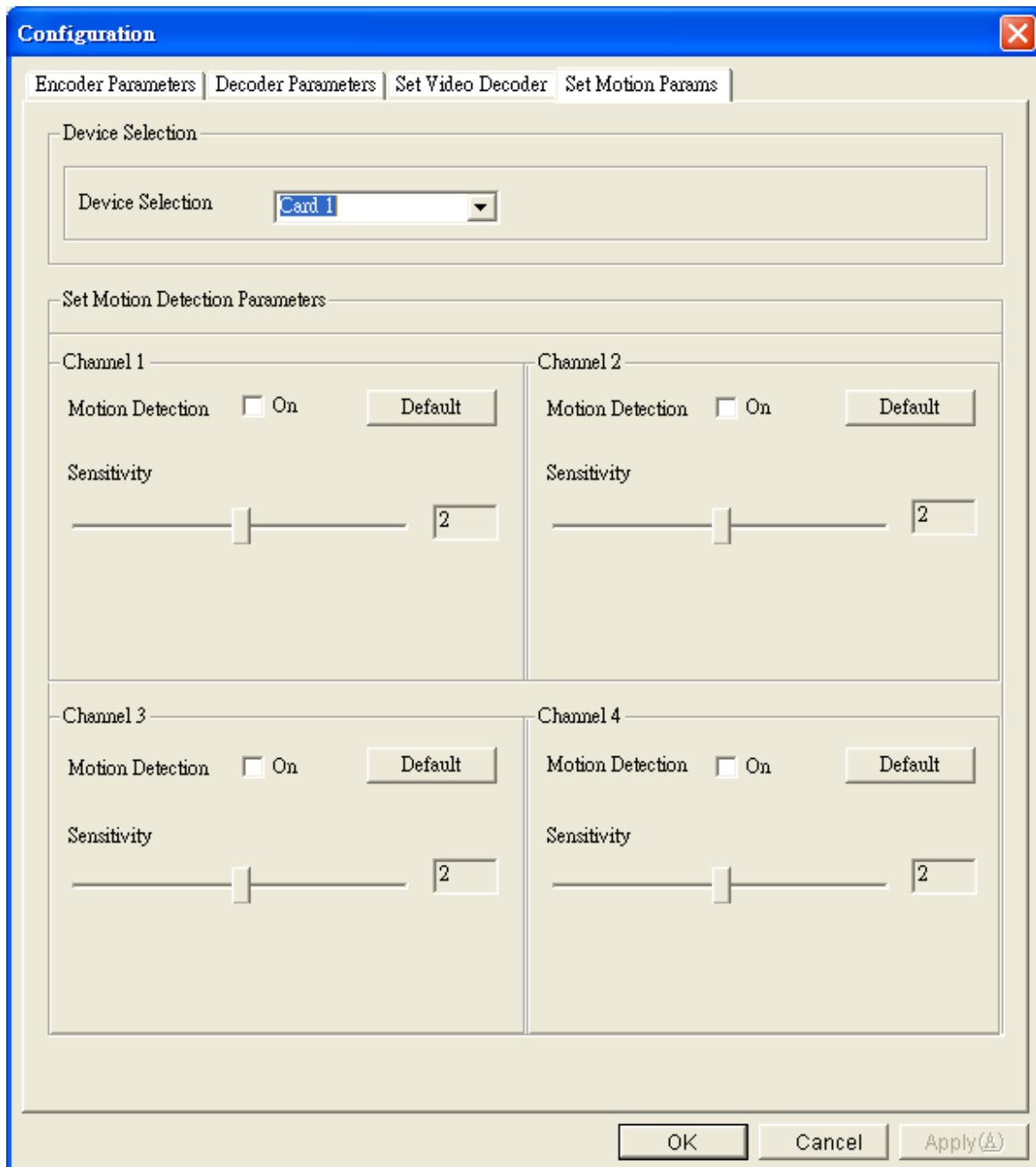

5.4.1. Device Selection

Device Selection : Select the target device to be configured

5.4.2. Set Motion Detection Parameters

On: Enable motion detection for the corresponding channel

Sensitivity: Set the sensitivity of detection level. Small value has more sensitivity.

Default: reset sensitivity value to default.

Click the  button to save the configuration.

Appendix A GPIO Connection

GP Input Connection

An input connector and an output connector are provided for connections to external devices. The connection points of the input connector are shown in the figure below.

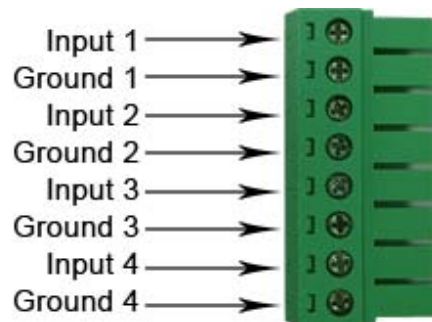

1. Please connect the "COM" on the sensor to the "Input".
2. Connect "NO"(Normal Open) or "NC"(Normal Close) to "DC"(0.5V - 24V).
3. Connect Ground of the Input Connector to the Ground of DC (0.5V - 24V).

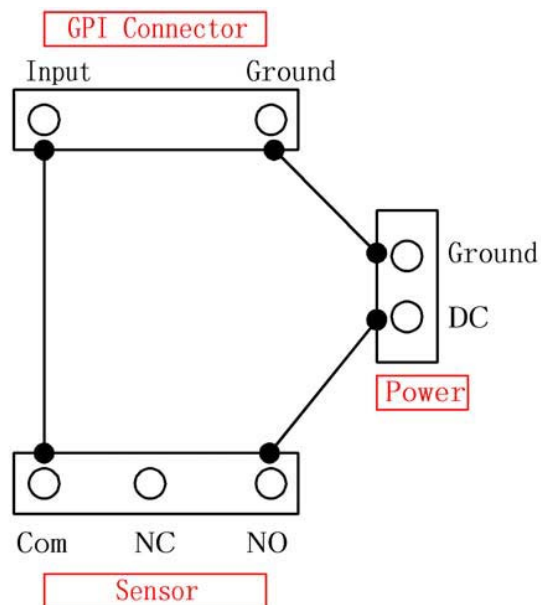

GP Output Connection

The connection points of the output connector are shown in the figure below.

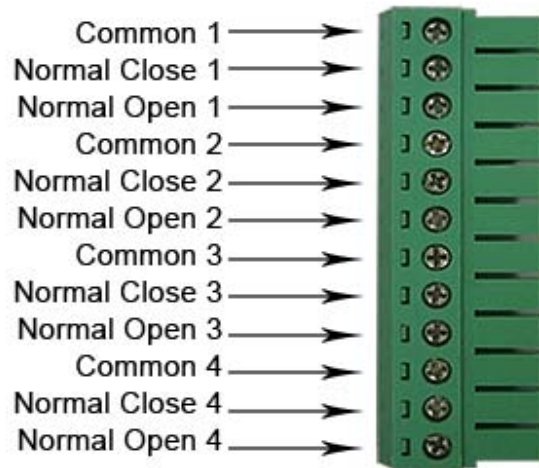

Operation procedure

1. The active state of DVR software configuration is Normal Open.
2. Com and NC should have signals before and after system is turned on.
3. When an event occurs, Com and NO will have signals.

Alarm devices should be connected to Com and Normal Open connectors so that event action will be triggered only when an event happens and will not be affected when system restarts.

Specification for General Inputs

The general inputs support DC voltage from 0~24V. Voltage of above 24V is not recommended.

	Voltage Range
Logic 0	< 0.5V
Logic 1	0.5V – 24V

Specification for General Outputs

Relay Contact Ratings

Contact Form	1 FORM C (SPDT)
Contact Capacity Resistive Load (cos θ = 1) Inductive Load (cos θ = 0.4 L/R = 7 msec)	coil = 0.36W 1A/125 VAC 2A/24 VDC 0.3A/30 VDC
Rated Carrying Current	2A
Max. allowable voltage	AC 120V. DC 60V
Max allowable current	2A
Max allowable power	48W
Contact Material	Ag Alloy

Relay Coil Specification

Coil voltage	Nominal Voltage (VDC)	Nominal Current (mA)	Coil Resistance (Ohm)	Power Consumption (W)
5V	5V	66.7	75	About 0.36W

Pull-in Voltage (VDC)	Drop-out voltage (VDC)	Max-Allowable Voltage (VDC)
75% max. 3.75V	10% min. 0.5V	110% 5.5V

After connecting your external device, you can plug the connector to the GPIO board.

Appendix B FAQ

1. **What kind of compression solution does IVC-8371P use? What is the minimum hardware requirement for using IVC-8371P?**

IVC-8371P is an MPEG-4 hardware video and audio encoding/Decode card. The dedicated hardware chip on the card encodes video stream as PS or AVI file formats, and decodes only **PS file** by hardware chip. Decoding AVI file needs to be performed by software via CPU resource. Usually, decoding 4 video channels of **AVI file** with full D1 resolution (720 x 480) needs Pentium 4 3.0G or faster CPU to achieve real-time decoding performance.

2. **Can IVC-8371P card driver be upgraded directly after first installation?**

No. To upgrade or re-install IVC-8371P device driver, or to add more IVC-8371P card into the system, you have to remove the existing IVC-8371P device driver and reboot the system. Then plug the new card to the system, or install the undated device driver directly.

3. **When using Windows device manager to remove single card, the system reboots automatically. How can this problem be solved?**

Do not disable or uninstall single IVC-8371P capture device by Windows device manager; otherwise the system will reboot automatically whenever you try to enable or install the driver again. This is an OS issue, and will be solved in Windows XP Service Pack 2, or later editions.

4. **Why IVC-8371P cannot work properly on some on-board VGA cards? How can this be solved?**

Display of video for four or more channels costs lots of system and display card resources that some on-board VGA cards cannot handle well. Below is a list of VGA card drivers verified by IEI. You can refer to the list for consideration of types of VGA card to use with IVC-8371P.

Windows 2000 + SP4 for an Intel 865G based VGA card: VGA driver version 6.14.10.3943, 6.14.10.3619 works fine.

Windows XP + SP1 for an Intel 865G based VGA card: VGA driver version 6.14.10.3943, 6.14.10.3510 works fine.

Windows XP + SP2 for an Intel 865G based VGA card: VGA driver version 6.14.10.3943 works fine.

5. When multiple cards are inserted at the same time, can the same ID be assigned to them?

No. A unique card ID has to be assigned to each card for IVC-8371P to identify which channels the device is mapped to. Identical card ID may cause system malfunctioning.