



DIAMOND SYSTEMS CORPORATION

ATHENA™

*High Integration CPU
with Ethernet and Data Acquisition*

Model ATH400-128, ATH400-128N, ATH660-128, ATH660-128N

User Manual Revision 1.20

Document # 765820



Copyright © 2004
Diamond Systems Corporation
8430-D Central Ave.
Newark, CA 94560
Tel (510) 456-7800
www.diamondsystems.com

TABLE OF CONTENTS

1.	DESCRIPTION	5
2.	FEATURES	6
3.	ATHENA BOARD DRAWING	8
4.	I/O HEADERS	9
4.1	PC/104 Bus Connectors	9
4.2	Main I/O Connector – J3.....	10
4.3	Input Power – J11	12
4.4	Output Power – J12.....	13
4.5	Ethernet – J4.....	13
4.6	USB – J5 (USB 0/1), J21 (USB 2/3).....	13
4.7	Watchdog Features – J6.....	14
4.8	IDE Drive – J8	14
4.9	Data Acquisition I/O Connector – J14 (Models with Data Acquisition only).....	15
4.10	LCD Panel (LVDS Interface) Connector – J24.....	16
4.11	LCD Backlight Connector – J28	17
4.12	CPU Fan Connector – J27.....	17
4.13	VGA Connector – J25	18
4.14	Audio I/O Connector – J15	19
4.15	CD Input Connector – J30	20
5.	JUMPER SETTINGS.....	21
5.1	J10: System Configuration.....	21
5.2	J13: Data Acquisition Circuit Configuration.....	23
5.3	J6: Watchdog Timer & System Recovery	24
6.	SYSTEM FEATURES.....	25
6.1	System Resources	25
6.2	COM Port / FPGA / Watchdog Control Registers	26
6.3	Console Redirection to a Serial Port.....	27
6.4	Flash Memory	28
6.5	Backup Battery.....	28
6.6	System Reset.....	28
6.7	On-Board Video	28
7.	BIOS	29
7.1	BIOS Settings	29
7.2	BIOS Console Redirection Settings	31
8.	SYSTEM I/O.....	32
8.1	Ethernet.....	32
8.2	Serial Ports.....	32
8.3	PS/2 Ports.....	33
8.4	USB Ports.....	33
9.	NOTES ON OPERATING SYSTEMS AND BOOTING PROCEDURES	34
9.1	Windows Operating Systems Installation Issues	34
9.1.1	Driver installation	34
9.1.2	BIOS Settings for Windows.....	34
9.2	DOS Operating Systems Installation Issues	35
10.	DATA ACQUISITION CIRCUIT – I/O MAP AND REGISTER DESCRIPTIONS	36
10.1	Base Address.....	37
10.2	Data Acquisition Circuit Register Map.....	38
10.3	Register Bit Definitions	39
11.	ANALOG-TO-DIGITAL INPUT RANGES AND RESOLUTION	51
11.1.1	Overview.....	51
11.2	Input Range Selection.....	51
11.3	Input Range Table.....	51
12.	PERFORMING AN A/D CONVERSION.....	52
12.1	Select the input channel.....	52

12.2	Select the input range.....	52
12.3	Wait for analog input circuit to settle.....	52
12.4	Perform an A/D conversion on the current channel.....	53
12.5	Wait for the conversion to finish.....	53
12.6	Read the data from the board.....	53
12.7	Convert the numerical data to a meaningful value.....	54
13.	A/D SCAN, INTERRUPT, AND FIFO OPERATION.....	55
13.1	Athena A/D Operating Modes.....	56
14.	ANALOG OUTPUT RANGES AND RESOLUTION.....	57
14.1	Description.....	57
14.2	Resolution.....	57
14.3	Output Range Selection.....	57
14.4	D/A Conversion Formulas and Tables.....	58
15.	GENERATING AN ANALOG OUTPUT.....	60
15.1	Compute the D/A code for the desired output voltage.....	60
15.2	Write the value to the selected output channel.....	60
15.3	Wait for the D/A to update.....	60
16.	ANALOG CIRCUIT CALIBRATION.....	61
16.1	A/D bipolar offset.....	61
16.2	A/D unipolar offset.....	61
16.3	A/D full-scale.....	61
16.4	D/A full scale.....	61
17.	DIGITAL I/O OPERATION.....	62
18.	COUNTER/TIMER OPERATION.....	63
18.1	Counter 0 – A/D Sample Control.....	63
18.2	Counter 1 – Counting/Totalizing Functions.....	63
18.3	Command Sequences.....	64
19.	WATCHDOG TIMER PROGRAMMING.....	66
19.1	Watchdog Timer.....	66
19.2	Watchdog Timer Register Details.....	67
19.3	Example : Watchdog Timer With Software Trigger.....	69
19.4	Example : Watchdog Timer With Hardware Trigger.....	69
20.	DATA ACQUISITION SPECIFICATIONS.....	70
21.	FLASHDISK MODULE.....	71
21.1	Installing the Flashdisk Module.....	71
21.2	Configuration.....	71
21.3	Using the Flashdisk with Another IDE Drive.....	71
21.4	Power Supply.....	71
22.	FLASH DISK PROGRAMMER BOARD.....	72
23.	I/O CABLES.....	73
24.	QUICK START GUIDE.....	74
24.1	General Setup.....	74
24.2	IDE Configuration.....	74
24.3	Booting into MS-DOS, FreeDOS or ROM-DOS.....	75
24.4	Booting into Linux or Microsoft Windows.....	75

TABLES

Table 1: J1,J2 – PC/104 Connector Pinouts	9
Table 2: J3 – Main I/O Connector.....	10
Table 3: J11 – Input Power Connector Pinout.....	12
Table 4: J12 – Output Power Connector Pinout	13
Table 5: J4 – Ethernet Connector Pinout	13
Table 6: J5, J21 – USB Connector Pinout.....	13
Table 7: J6 – Watchdog Connector Pinout.....	14
Table 8: J8 – IDE Drive Connector Pinout.....	14
Table 9: J14 – Data Acquisition Connector Pinout.....	15
Table 10: J24 – LCD Connector Pinout.....	16
Table 11: J28 – LCD Backlight Connector Pinout	17
Table 12: J27 – CPU Fan Connector Pinout	17
Table 13: J25 – VGA Header Pinout	18
Table 14: J15 – Amplified Speaker Connector Pinout.....	19
Table 15: J30 – CD Input Connector Pinout.....	20
Table 16: System Resources	25
Table 17: I/O COM3/4 Control Register Definition	26
Table 18: J11 – Ethernet Connector.....	32
Table 19: COM PORT Default Resource Listing.....	32
Table 20: Data Acquisition : Analog Input Range	51
Table 21: A/D Operating Modes	56
Table 22: I/O COM3/4 Control Register Definition	66
Table 23: Cable Kit C-ATH-KIT Contents.....	73

FIGURES

Figure 1 : ACC-IDEEXT <i>FlashDisk Programmer Board</i>	72
Figure 2 : Cable Kit C-ATH-KIT	73

1. DESCRIPTION

Athena is an embedded CPU board in a modified PC/104 form factor that integrates a complete embedded PC, consisting of the following subsystems onto a single compact board:

- ◆ CPU
- ◆ Core PC Chipset (including memory controller, PCI interface, and ISA interface)
- ◆ Video
- ◆ Sound
- ◆ Ethernet
- ◆ Analog I/O

A detailed list of features is shown on the next page.

The single board Athena computer is a Pentium III class device with onboard central processing, memory and memory management devices and I/O management for specific functions. It is larger than the PC-104 PCB format on two sides, but uses the PC-104 mounting method and interface specification. The computer communicates externally via an ISA bus as well as the specified I/O ports. It generates onboard RGB video for CRT display systems and contains LVDS formatting to drive a flat panel. The single board computer is powered from an externally regulated +5VDC supply. The frequencies of processor operation and onboard RAM memory are:

Model	Processor Speed	RAM Size	Data Acquisition
ATH 400-128	400 Mhz	128MB	Yes
ATH 400-128N	400 Mhz	128MB	No
ATH 660-128	660 Mhz	128MB	Yes
ATH 660-128N	660 Mhz	128MB	No

The 400 Mhz Athena models are convection cooled (heat sink only). An integrated heat sink + fan is provided for the 660 Mhz models.

The Athena CPU uses the ISA bus internally to connect serial ports 1 through 4, as well as the data acquisition circuit, to the processor. The ISA bus is brought out to an expansion connector to mate with add-on boards. Diamond Systems manufactures a wide variety of compatible PC/104 add-on boards for analog I/O, digital I/O, counter/timer functions, serial ports, and power supplies.

2. FEATURES

System Features

Processor Section

- ◆ Via Eden Processor running at 400MHz or 660MHz with integrated math co-processor
- ◆ Pentium-class platform including SDRAM, IDE controller and USB

Core System

- ◆ 128MB SDRAM system memory (standard)
- ◆ 100MHz memory bus
- ◆ 2MB 16-bit wide integrated flash memory for BIOS and user programs
- ◆ 2D VGA Video graphics engine (VESA-style VGA output with DDC Monitor support)

I/O

- ◆ 4 RS-232 serial ports, 115.2kbaud max
 - ◆ 2 ports 16550-compatible
 - ◆ 2 ports 16850-compatible with 128-byte FIFOs
- ◆ 4 USB 1.1 ports
- ◆ IDE drive connectors; 44 pin notebook drive connection
- ◆ Accepts solid-state flash disk module directly on board
- ◆ 10/100 BaseT full-duplex PCI bus mastering Ethernet (100Mbps or 10Mbps)
- ◆ IrDA port (requires external transceiver, not included)
- ◆ PS/2 keyboard and mouse ports
- ◆ LEDs
- ◆ Interface for speaker and additional external LEDs

System Features

- ◆ Plug and play BIOS with IDE auto detection, 32-bit IDE access, and LBA support
- ◆ User-selectable console redirection terminal mode on either COM1 or COM2
- ◆ On-board lithium backup battery for real-time-clock and CMOS RAM
- ◆ ATX power switching capability
- ◆ Programmable watchdog timer
- ◆ Extended temperature range operation (-40 to +85°C)

Data Acquisition Subsystem

Analog Input

- ◆ 16 single-ended / 8 differential inputs, 16-bit resolution
- ◆ 100KHz maximum aggregate A/D sampling rate
- ◆ Programmable input ranges/gains with maximum range of $\pm 10V$ / 0-10V
- ◆ Both bipolar and unipolar input ranges
- ◆ 10 ppm/ $^{\circ}C$ drift accuracy
- ◆ Internal and external A/D triggering
- ◆ 48-sample FIFO for reliable high-speed sampling and scan operation

Analog Output

- ◆ 4 analog outputs, 12-bit resolution
- ◆ $\pm 10V$ and 0-10V output ranges
- ◆ $\pm 5V$ and 0-5V output range (optional)

Digital I/O

- ◆ 24 programmable digital I/O, 3.3V and 5V logic compatible
- ◆ Enhanced output current capability: $-8/+12mA$ max

Counter/Timers

- ◆ 1 24-bit counter/timer for A/D sampling rate control
- ◆ 1 16-bit counter/timer for user counting and timing functions
- ◆ Programmable gate and count enable
- ◆ Internal and external clocking capability

4. I/O HEADERS

All cables mentioned in this chapter are included in Diamond Systems' cable kit **C-ATH-KIT**. These cables are further described in chapter 23. Some cables are also available individually.

4.1 PC/104 Bus Connectors

The PC/104 bus is essentially identical to the ISA Bus except for the physical design. It specifies two pin and socket connectors for the bus signals. A 64-pin header J1 incorporates the 62-pin 8-bit bus connector signals, and a 40-pin header J2 incorporates the 36-pin 16-bit bus connector signals. The additional pins on the PC/104 connectors are used as ground or key pins. The female sockets on the top of the board and the extended mating pins on the bottom of the board enable PC/104 board stacking.

In the pinout figures below, the tops correspond to the left edge of the connector when the board is viewed from the primary side (side with the CPU chip and the female end of the PC/104 connector) and the board is oriented so that the PC/104 connectors are along the bottom edge of the board.

View from Top of Board

J2: PC/104 16-bit bus connector

Ground	D0	C0	Ground
MEMCS16-	D1	C1	SBHE-
IOCS16-	D2	C2	LA23
IRQ10	D3	C3	LA22
IRQ11	D4	C4	LA21
IRQ12	D5	C5	LA20
IRQ15	D6	C6	LA19
IRQ14	D7	C7	LA18
DACK0-	D8	C8	LA17
DRQ0	D9	C9	MEMR-
DACK5-	D10	C10	MEMW-
DRQ5	D11	C11	SD8
DACK6-	D12	C12	SD9
DRQ6	D13	C13	SD10
DACK7-	D14	C14	SD11
DRQ7	D15	C15	SD12
+5V	D16	C16	SD13
MASTER-	D17	C17	SD14
Ground	D18	C18	SD15
Ground	D19	C19	Key (pin cut)

J1: PC/104 8-bit bus connector

IOCHCHK-	A1	B1	Ground
SD7	A2	B2	RESET
SD6	A3	B3	+5V
SD5	A4	B4	IRQ9
SD4	A5	B5	-5V
SD3	A6	B6	DRQ2
SD2	A7	B7	-12V
SD1	A8	B8	OWS-
SD0	A9	B9	+12V
IOCHRDY	A10	B10	Key (pin cut)
AEN	A11	B11	SMEMW-
SA19	A12	B12	SMEMR-
SA18	A13	B13	IOW-
SA17	A14	B14	IOR-
SA16	A15	B15	DACK3-
SA15	A16	B16	DRQ3
SA14	A17	B17	DACK1-
SA13	A18	B18	DRQ1
SA12	A19	B19	Refresh-
SA11	A20	B20	SYSCLK
SA10	A21	B21	IRQ7
SA9	A22	B22	IRQ6
SA8	A23	B23	IRQ5
SA7	A24	B24	IRQ4
SA6	A25	B25	IRQ3
SA5	A26	B26	DACK2-
SA4	A27	B27	TC
SA3	A28	B28	BALE
SA2	A29	B29	+5V
SA1	A30	B30	OSC
SA0	A31	B31	Ground
Ground	A32	B32	Ground

Table 1: J1,J2 – PC/104 Connector Pinouts

4.2 Main I/O Connector – J3

An 80-pin high-density connector is provided for access to the user I/O. The following functions are supported by this connector:

- ◆ 2 serial ports
- ◆ PS/2 keyboard
- ◆ ATX Power switch
- ◆ Parallel port
- ◆ PS/2 mouse
- ◆ Reset switch
- ◆ Watchdog timer I/O
- ◆ IrDA port
- ◆ Power and HDD LEDs

The connector mates with Diamond Systems' cable no. **C-PRZ-01**, which consists of a dual-ribbon-cable assembly with industry-standard connectors at the user end. The CPU mating connector includes integral latches for enhanced reliability. Each ribbon cable has 40 wires.

Cable "A"			Cable "B"		
COM 1	1	DCD1	LPT 1	1	STB-
	2	DSR 1		2	AFD-
	3	RXD 1		3	PD0
	4	RTS 1		4	ERR-
	5	TXD 1		5	PD1
	6	CTS 1		6	INIT-
	7	DTR 1		7	PD2
	8	RI 1		8	SLIN-
COM 2	9	Ground	9	PD3	
	10	DCD 2	10	Ground	
	11	DSR 2	11	PD4	
	12	RXD 2	12	Ground	
	13	RTS 2	13	PD5	
	14	TXD 2	14	Ground	
	15	CTS 2	15	PD6	
	16	DTR 2	16	Ground	
COM 3	17	RI 2	17	PD7	
	18	Ground	18	Ground	
	19	DCD 3	19	ACK-	
	20	DSR 3	20	Ground	
	21	RXD 3	21	BUSY	
	22	RTS 3	22	Ground	
	23	TXD 3	23	PE	
	24	CTS 3	24	Ground	
COM 4	25	DTR 3	25	SLCT	
	26	RI 3	26	KB Clk	
	27	Ground	27	Keyboard	
	28	DCD 4	28	KB/MS V-	
	29	DSR 4	29	KB Data	
	30	RXD 4	30	KB/MS V+	
	31	RTS 4	31	Mouse	
	32	TXD 4	32	MS Clk	
Utilities A	33	CTS 4	33	KB/MS V-	
	34	DTR 4	34	MS Data	
	35	RI 4	35	KB/MS V+	
	36	Ground	36	Ground	
	37	+5V Out	37	Utilities B	
	38	Speaker Out	38	Reset-	
	39	IDE Drive LED	39	ATX Power	
	40	Power LED	40	KB Lock	
			38	IR RX	
			39	IR TX	
			40	+3VSB	

Table 2: J3 – Main I/O Connector

Notes on J3 Signals

COM1 – COM4 The signals on these pins are RS-232 level signals and may be connected directly to RS-232 devices. The pinout of these signals is designed to allow a 9-pin male IDC connector to be crimped onto the corresponding ribbon cable wires to provide the correct pinout for a PC serial port connector (DTE).

LPT1 The signals on these pins comprise a standard PC parallel port. The pinout of these signals is designed to allow a 25-pin female IDC connector to be crimped onto the corresponding ribbon cable wires to provide the correct pinout for a PC parallel port connector.

Keyboard, Mouse These are PS/2 signals for keyboard and mouse.

Clk Clock pin; connects to pin 5 of the PS/2 connector.

V- Power pin; connects to pin 3 of the PS/2 connector.

Data Data pin; connects to pin 1 of the PS/2 connector.

V+ Power pin; connects to pin 4 of the PS/2 connector.

Pins 2 and 6 on the Mini-Din-6 PS/2 connectors are unused.

Utilities A

+5V Out This pin is a switched power pin that is turned on and off with the ATX power switch or with the +5V input.

Speaker Out The signal on this pin is referenced to +5V Out. Connect a speaker between this pin and +5V Out.

IDE Drive LED Referenced to +5V Out. Does not require a series resistor. Connect LED directly between this pin and +5V Out.

Power LED Referenced to +5V Out. Does not require a series resistor. Connect LED directly between this pin and +5V Out.

Utilities B

Reset- Connection between this pin and Ground will generate a Reset condition.

ATX Power When ATX is enabled, a momentary contact between this pin and ground causes the CPU to turn on, and a contact of 4 seconds or longer will generate a power shutdown. ATX power control is enabled with a jumper on jumper block J10 (see page 21).

KB Lock When this pin is connected to Ground, the keyboard and mouse inputs are ignored.

IR RX, IR TX IrDA pins. Can be connected directly to an IrDA transceiver.

+5V In Connected to +5V input power on J11 (see page 12). This pin is not switched by ATX control. This pin is provided for auxiliary use such as front panel lighting or other circuitry at the user's discretion.

Connector Part Numbers

J3 plug on CPU board: 3M / Robinson Nugent no. P50E-080P1-S1-TG

Both cable-mount and board-mount connectors are available to mate with J3:

Cable-mount socket: 3M / Robinson Nugent no. P50E-080S-TG

Board-mount socket: 3M / Robinson Nugent no. P50-080S-R1-TG

4.3 Input Power – J11

1	+5V In
2	Ground
3	Ground
4	+12V In
5	Ground
6	+5V In
7	-12V In
8	-5V In
9	ATX Control

Table 3: J11 – Input Power Connector Pinout

Input power for Athena may be supplied either through J11 from an external supply or directly through the PC/104 bus power pins if a PC/104 power supply is used with the CPU.

Athena requires only +5VDC input power to operate. All other required voltages are generated on board with miniature switching regulators. However since the PC/104 bus includes pins for $\pm 5V$ and $\pm 12V$, these voltages may be supplied through J11 if needed. The +5V and +12V voltages are controlled by the ATX power manager switches, while -5V and -12V are routed directly to the corresponding pins on PC/104 bus and are not controlled by the ATX function.

Make sure that the power supply used has enough current capacity to drive your system. The Athena CPU requires up to 2A on the +5V line for the 400Mhz configuration (2.7A for the 660Mhz configuration.) If you have a disk drive or other modules connected, you need additional power. In particular, many disk drives need extra current during startup. If your system fails to boot properly, or if disk accesses do not work properly, the first thing to check is the power supply voltage level. Many boot-up problems are caused simply by insufficient voltage due to excess current draw on the +5V supply.

Multiple +5V and Ground pins are provided for extra current carrying capacity if needed. Each pin is rated at 3A max (15W). For the Athena CPU and panel I/O board 3A is sufficient, so +5 and Ground require only a single wire each. In this case the first 4 pins may be connected to a standard 4-pin miniature PC power connector if desired. Be advised that some voltage will be dropped in the wire depending on the wire gauge (AWG).

For a larger PC/104 stack the total power requirements should be calculated to determine whether additional wires are necessary.

ATX control enables the +5V and +12V power to be switched on and off with an external momentary switch. A short press on the switch will turn on power, and holding the switch on for 4 seconds or longer will turn off power.

Diamond Systems' cable no. **698009** mates with J11. It provides 9 color-coded wires with stripped and tinned leads for connection to user-supplied power sources. This cable may also be used with Diamond Systems' Jupiter-MM series power supplies in vehicle-based applications. In this configuration, the input power is supplied to the Jupiter-MM board, and the Jupiter-MM output power is connected to J11 on the CPU using cable 698009. When used in this way, make sure the two red +5V wires are both connected to the +5V output screw terminal on Jupiter-MM and the Jupiter-MM is not plugged onto the PC/104 stack.

4.4 Output Power – J12

1	+5V Out
2	Ground
3	Ground
4	+12V Out

Table 4: J12 – Output Power Connector Pinout

J12 provides switched power for use with external drives. If ATX is enabled, the power is switched on and off with the ATX input switch. If ATX is not enabled, the power is switched on and off in conjunction with the external power.

Diamond Systems' cable no. **698006** mates with J12. It provides a standard full-size power connector for a hard drive or CD-ROM drive and a standard miniature power connector for a floppy drive.

Connector Part Numbers

J12 Connector on CPU board:	Digi-Key Corp. 640456-4
J12 Mating Cable Connector:	Molex 22-01-3047

4.5 Ethernet – J4

1	Common
2	RX-
3	Common
4	RX+
5	TX-
6	TX+

Table 5: J4 – Ethernet Connector Pinout

J4 is a 1x6 pin header. It mates with Diamond Systems' cable no. **698002**, which provides a panel-mount RJ-45 jack for connection to standard CAT5 network cables.

Connector Part Numbers

J11 Connector on CPU board:	Digi-Key Corp. 640456-6
J11 Cable Connector:	Molex 16-02-0096

4.6 USB – J5 (USB 0/1), J21 (USB 2/3)

Key (pin cut)	1	2	Shield
USB2 Pwr-	3	4	USB1 Pwr-
USB2 Data+	5	6	USB1 Data+
USB2 Data-	7	8	USB1 Data-
USB2 Pwr+	9	10	USB1 Pwr+

Table 6: J5, J21 – USB Connector Pinout

J5 and J21 are 2x5 pin headers. They mate with Diamond Systems' cable no. **698012**, each providing 2 standard USB type A jacks in a panel-mount housing.

Connector Part Numbers

J5, J21 Connector on CPU board:	Standard 2x5, 0.1" header (with pin 1 removed)
J5, J21 Mating Cable Connector:	Oupiin 4072-2X5H (Standard PC USB Header Interface)

4.7 Watchdog Features – J6

1	Ground
2	WDI
3	WDO

Table 7: J6 – Watchdog Connector Pinout

J6 is used for watchdog timer access.

The watchdog timer circuit is described on page 66 of this manual. It may be programmed directly, as described in this user manual, or with Diamond Systems' Universal Driver software.

4.8 IDE Drive – J8

RESET-	1	2	Ground
D7	3	4	D8
D6	5	6	D9
D5	7	8	D10
D4	9	10	D11
D3	11	12	D12
D2	13	14	D13
D1	15	16	D14
D0	17	18	D15
Ground	19	20	Key (Not Used)
DRQ	21	22	Ground
IDEIOW-	23	24	Ground
IDEIOR-	25	26	Ground
IORDY	27	28	Ground
DACK-	29	30	Ground
IRQ14	31	32	Pulled low for 16-bit operation
A1	33	34	Not Used
A0	35	36	A2
CS0-	37	38	CS1-
LED-	39	40	Ground
+5V	41	42	+5V
Ground	43	44	Not Used

Table 8: J8 – IDE Drive Connector Pinout

J8 is a 2x22 (44-pin) 2mm-pitch pin header. It mates with Diamond Systems' cable no. **698004**, and may be used to connect up to 2 IDE drives (hard disks, CD-ROMs, or flashdisk modules). The 44-pin connector includes power and mates directly with notebook drives and flashdisk modules. To use a standard format hard disk or CD-ROM drive with a 40-pin connector, an adapter PCB such as Diamond Systems' ACC-IDEEXT is required.

4.9 Data Acquisition I/O Connector – J14 (Models with Data Acquisition only)

Athena includes a 50-pin header labeled J14 for all data acquisition I/O. This header is located on the left side of the board. Pin 1 is the lower right pin and is marked on the board. Diamond Systems' cable no. **C-50-18** provides a standard 50-pin connector at each end and mates with this header.

DIO A0	1	2	DIO A1
DIO A2	3	4	DIO A3
DIO A4	5	6	DIO A5
DIO A6	7	8	DIO A7
DIO B0	9	10	DIO B1
DIO B2	11	12	DIO B3
DIO B4	13	14	DIO B5
DIO B6	15	16	DIO B7
DIO C0	17	18	DIO C1
DIO C2	19	20	DIO C3
DIO C4 / Gate 0	21	22	DIO C5 / Gate 1
DIO C6 / Clk 1	23	24	DIO C7 / Out 0
Ext Trig	25	26	Tout 1
+5V Out	27	28	Dground
Vout 0	29	30	Vout 1
Vout 2	31	32	Vout 3
Aground (Vout)	33	34	Aground (Vin)
Vin 0	35	36	Vin 8
Vin 1	37	38	Vin 9
Vin 2	39	40	Vin 10
Vin 3	41	42	Vin 11
Vin 4	43	44	Vin 12
Vin 5	45	46	Vin 13
Vin 6	47	48	Vin 14
Vin 7	49	50	Vin 15

Table 9: J14 – Data Acquisition Connector Pinout

Signal Name	Definition
DIO A7-A0	Digital I/O port A; programmable direction
DIO B7-B0	Digital I/O port B; programmable direction
DIO C7-C0	Digital I/O port C; programmable direction C7-C4 may be configured for counter/timer signals; see page 47
Ext Trig	External A/D trigger input
Tout 1	Counter/Timer 1 output
Vin 7/7+ ~ Vin 0/0+	Analog input channels 7 – 0 in single-ended mode; High side of input channels 7 – 0 in differential mode
Vin 15/7- ~ Vin 8/0-	Analog input channels 15 – 8 in both single-ended mode; Low side of input channels 7 – 0 in differential mode
Vout0-3	Analog output channels 0 – 3
+5V Out	Connected to switched +5V supply
Aground (Vout), (Vin)	Analog ground; used for analog circuitry only Vout pin is for the analog outputs; Vin pin is for the analog inputs
Dground	Digital ground; used for digital circuitry only

4.10 LCD Panel (LVDS Interface) Connector – J24

Ground	1	2	Ground
Y CLOCK -	3	4	Z CLOCK -
Y CLOCK +	5	6	Z CLOCK +
Ground	7	8	Ground
Y Data 0 -	9	10	Z Data 0 -
Y Data 0 +	11	12	Z Data 0 +
Ground	13	14	Ground
Y Data 2 -	15	16	Z Data 1 -
Y Data 2 +	17	18	Z Data 1 +
Ground	19	20	Ground
Y Data 1 -	21	22	Z Data 2 -
Y Data 1 +	23	24	Z Data 2 +
Ground	25	26	Ground
VDD (LCD Display)	27	28	VDD (LCD Display)
VDD (LCD Display)	29	30	VDD (LCD Display)

Table 10: J24 – LCD Connector Pinout

J24 provides access to the internal LVDS LCD display drivers. Note that the LCD also requires the backlight to be connected (J28 below) in order to function correctly.

Signal Name	Definition
Y Data 2-0 +/-	Primary Data Channel, bits 2-0 (LVDS Differential signaling)
Y Clock +/-	Primary Data Channel, Clock (LVDS Differential signaling)
Z Data 2-0 +/-	Secondary Data Channel, bits 2-0 (LVDS Differential signaling)
Z Clock +/-	Secondary Data Channel, Clock (LVDS Differential signaling)
VDD	+3.3V Switched Power Supply for LCD display (only powered up when LCD display is active)
Ground	Power Ground, 0V

Connector Part Numbers

J24 plug on CPU board:	JST Part Number: BM30B-SRDS-G-TF
Cable-mount socket:	JST Part Number: JST SHDR-30V-S-B

4.11 LCD Backlight Connector – J28

1	+12V
2	Control
3	Ground

Table 11: J28 – LCD Backlight Connector Pinout

Signal Name	Definition
Control	Output signal (from Athena) to allow power-down of backlight
+12V, Ground	Power Supply for LCD Backlight assembly

J28 provides the Backlight power and control for the optional LCD panel. See J24 (above) for details on the LCD data interface. Note that the +12V supply will be removed when the system is powered down; the control signal is to allow the system to power-down the backlight when the system enables monitor-power-down during its power management control.

Note: 12V must be provided either on the J11 input power connector or on the 12V pin on the PC/104 connector in order for the LCD backlight to operated. This voltage is not generated internally.

Connector Part Numbers

J28 Connector on CPU board:	Digi-Key Corp.	A19470
J28 Mating Cable Connector:	Molex	22-01-3037

4.12 CPU Fan Connector – J27

1	Fan RPM
2	Ground
3	+5V

Table 12: J27 – CPU Fan Connector Pinout

Signal Name	Definition
Fan-RPM	TTL signal input that pulses with each revolution of the fan
+5V, Ground	Power Supply for optional CPU Fan (if necessary)

Connector Part Numbers

J27 Connector on CPU board:	Heilind Electronics	89400-0320
J27 Mating Cable Connector:	JST	PHR-3

4.13 VGA Connector – J25

GREEN	1	2	RED
BLUE	3	4	Ground
HSYNCH	5	6	DDC-Data
VSYNCH	7	8	DDC-Clock

Table 13: J25 – VGA Header Pinout

Signal Name	Definition
RED	RED signal (positive, 0.7Vpp into 75 Ohm load)
GREEN	GREEN signal (positive, 0.7Vpp into 75 Ohm load)
BLUE	BLUE signal (positive, 0.7Vpp into 75 Ohm load)
Ground	Ground return
DDC-CLOCK/DATA	Digital serial I/O signals used for monitor detection (DDC1 specification)

J25 provides a connection for VGA monitors. Note that while the DDC serial detection pins are present, there is no 5V supply provided (nor are the old “Monitor ID” pins used). Diamond Cable Assembly #698024 provides a female DB15 connection to interface with a standard RGB monitor.

Connector Part Numbers

J25 Connector on CPU board:	Standard 2x5, 0.1” Box header
J25 Mating Cable Connector:	Standard 2x5, 0.1” female ribbon cable connector

4.14 Audio I/O Connector – J15

1	LEFT Headphone / Line Out
2	RIGHT Headphone / Line Out
3	Audio Ground
4	LEFT Line Input
5	RIGHT Line Input
6	Audio Ground
7	Microphone Input
8	Power Reference for Microphone
9	NC (Key)
10	Audio Ground

Table 14: J15 – Audio I/O Connector Pinout

<u>Signal Name</u>	<u>Definition</u>
Headphone / Line Out	Line Level output, capable of driving headphones Referred to as “Headphone Out” in most sound documentation
Line Input	Line-Level input; referred to as “Line In” in most sound documentation
Microphone Input	Microphone-level mono input; phantom power provided via pin 8

The sound chip used is AC97-compatible. The line-level output listed above is listed as either “Headphone Out” or “Line Out 2” in most of the software and documentation for this sound interface.

Connector Part Numbers

J15 Connector on CPU board: Standard 2x5, 0.1” Box header

4.15 CD Input Connector – J30

J30 provides a connector for a PC-standard CD input cable.

1	LEFT CD Input
2	Left Ground
3	Right Ground
4	RIGHT CD Input

Table 15: J30 – CD Input Connector Pinout

J30 provides the CD Audio Input to the AC97 Sound circuitry. The connector is an industry-standard CD-IN connector, as is common in most desktop Personal Computers. Note that the left and right grounds are decoupled, but are also tied together on-board. This input is intended for CD-input only (i.e., no amplified or microphone inputs).

Connector Part Numbers

J30 Connector on CPU board:

Molex 70543-0003

J30 Mating Cable Connector:

Standard (PC) CD Audio cable

5. JUMPER SETTINGS

Refer to the Athena board drawing on page 8 for locations of the configuration items mentioned here. See page 23 for information on configuration J13 for the data acquisition circuit.

5.1 J10: System Configuration

Jumper block **J10** is used for configuration of IRQ levels, wait states, ATX power control, and CMOS RAM.

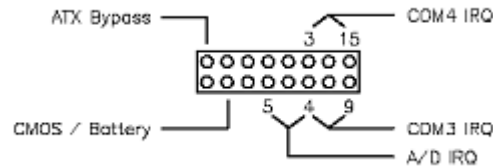

Serial Port and A/D IRQ Settings

COM3 may be set to IRQ4 or IRQ9. COM4 may be set to IRQ3 or IRQ15. The A/D circuit may be set to IRQ5 or IRQ4 if COM3 does not use it. In addition, it is possible to set up all 3 circuits to share IRQ4 or IRQ5. Note that only 1 device can use the 'shared' IRQ at one time. True IRQ sharing where all 3 devices can run simultaneously is not supported here.

ATX Power Control

Athena must have ATX enabled to function properly. This jumper must be installed for the board to boot when power is applied.

Erasing CMOS RAM

The CMOS RAM may be cleared with a jumper as shown on the next page. This will cause the CPU to power up with the default BIOS settings. To clear the CMOS RAM, power down the CPU, install the jumper as shown, return it to its default position, and then power up again.

Before erasing CMOS RAM, write down any custom BIOS settings you have made!

Default Settings

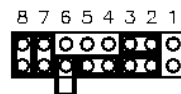

Default Settings:
COM3 = IRQ4
COM4 = IRQ3
A/D = IRQ5
Standard ISA bus wait state
Backup battery enabled
ATX bypass

The different configurations for J10 are shown below. Each illustration shows only the jumper of interest. An asterisk (*) indicates the default setting.

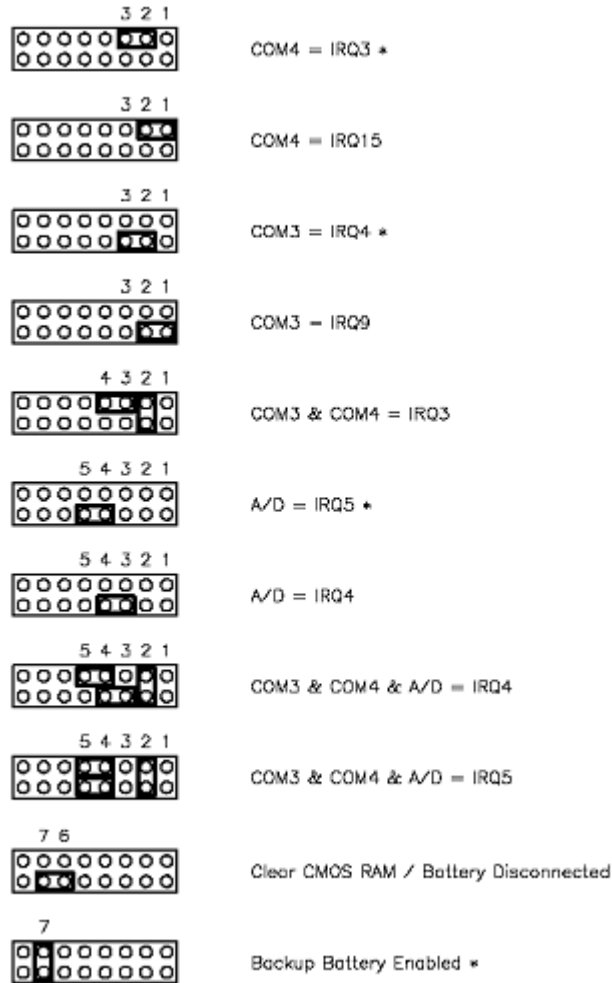

5.2 J13: Data Acquisition Circuit Configuration

Jumper block **J13** is used to configure the A/D and D/A circuits of the Athena. It is located on the left side of the board next to the data acquisition I/O pin header and is oriented vertically. The functions are shown below and are described in detail on the following page.

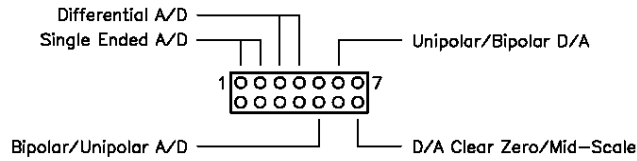

The default settings are as shown:

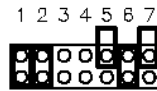

Default Settings: A/D Single-Ended, Bipolar
D/A Bipolar, Clear to Mid-Scale

The various configurations are illustrated and described below. For correct configuration, pick one option from the first two configurations (single-ended or differential A/D), one option from the second two configurations (unipolar or bipolar A/D), and one option from the third two configurations (unipolar or bipolar D/A).

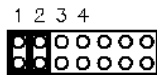

Single-Ended A/D

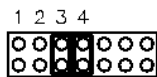

Differential A/D

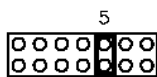

Unipolar A/D

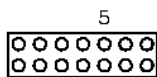

Bipolar A/D

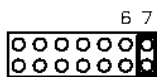

Unipolar D/A
+ Clear to Zero

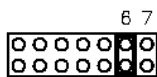

Bipolar D/A
+ Clear to Mid-Scale

Single-ended / Differential Inputs

Athena can accept both single-ended and differential inputs. A **single-ended** input uses 2 wires, input and ground. The measured input voltage is the difference between these two wires. A **differential** input uses 3 wires: input +, input -, and ground. The measured input voltage is the difference between the + and - inputs.

Differential inputs are frequently used when the grounds of the input device and the measurement device (Athena) are at different voltages, or when a low-level signal is being measured that has its own ground wire. A differential input also has higher noise immunity than a single-ended input, since most noise affects both + and - input wires equally, so the noise will be canceled out in the measurement. The disadvantage of differential inputs is that only half as many are available, since two input pins are required to produce a single differential input. Athena can be configured for either 16 single-ended inputs or 8 differential inputs.

If you have a combination of single-ended and differential input signals, select differential mode. Then to measure the single-ended signals, connect the signal to the + input and connect analog ground to the - input.

WARNING: The maximum range of voltages that can be applied to an analog input on Athena without damage is $\pm 35V$. If you connect the analog inputs on Athena to a circuit whose ground potential plus maximum signal voltage exceeds $\pm 35V$, the analog input circuit may be damaged. Check the ground difference between the input source and Athena before connecting analog input signals.

Unipolar / Bipolar Inputs

The analog inputs can be configured for unipolar (positive input voltages only) or bipolar (both negative and positive input voltages). For **unipolar** inputs, install a jumper as shown. For **bipolar** inputs, leave the jumper out.

Analog Output Configuration

The 4 analog outputs can also be configured for unipolar (positive voltages only) or bipolar (both negative and positive output voltages). In unipolar mode, the outputs range between 0-10V. In bipolar mode, the outputs range between $\pm 10V$.

When the board powers up or is reset, the analog outputs are also reset. The D/A reset method is selected with a jumper on J13. If the jumper is in, the outputs will reset to the bottom of their range (called zero-scale). If the jumper is out, the outputs will reset to the middle of their range (mid-scale). Normally the D/A is configured to power up to 0V, so that when the power is turned on the device connected to the analog output doesn't see a step change in voltage. Therefore, for unipolar mode normally the outputs should be configured for zero-scale reset, and for bipolar mode the outputs should be configured for mid-scale reset, since 0V is halfway between -10V and +10V for the $\pm 10V$ range.

5.3 J6: Watchdog Timer & System Recovery

J6 is used in conjunction with the watchdog timer. This jumper has different dimensions than J10 and J13, and the jumpers are not interchangeable.

Watchdog timer operation is described in detail on page 66.

6. SYSTEM FEATURES

6.1 System Resources

The table below lists the default system resources utilized by the circuits on Athena.

Device	Address (Hex)	ISA IRQ	ISA DMA
Serial Port COM1	I/O 3F8 – 3FF	4	-
Serial Port COM2	I/O 2F8 – 2FF	3	-
Serial Port COM3	I/O 3E8 – 3EF	9	-
Serial Port COM4	I/O 2E8 – 2EF	3	-
LPT Printer Port	I/O 378 – 37F	7	3
IDE Controller A	I/O 1F0 – 1F7	14	-
A/D Circuit (when applicable)	I/O 280 – 28F	5	-
Watchdog Timer / Serial Port / FPGA Enable/ Disable	I/O 25C – 25F	-	-
Ethernet	OS-dependant	OS-dependant	-
USB	OS-dependant	OS-dependant	-
Sound	OS-dependant	OS-dependant	-
Video	OS-dependant	OS-dependant	-

Table 16: System Resources

Note that most of these resources are configurable and, in many cases, the Operating System will alter these settings. The main devices that are subject to this dynamic configuration are on-board Ethernet, sound, video, USB, and any PC/104 cards that are in the system. These settings may also vary depending on what other devices are present in the system.

6.2 COM Port / FPGA / Watchdog Control Registers

A registers located at address 0x25F is used for the purposes of controlling the serial port, FPGA and watchdog features:

Register Map Bit Assignments

A blank bit in the write registers is unused. A blank bit in the read registers reads back as 0 or 1, unknown state.

WRITE

Address	7	6	5	4	3	2	1	0
0x25F	COM4EN	COM3EN	FPGAEN	WDEN				

READ

Address	7	6	5	4	3	2	1	0
0x25F	COM4EN	COM3EN	FPGAEN	WDEN				

Table 17: I/O COM3/4 Control Register Definition

0x25F Write Chip select enable/disable

Bit No.	7	6	5	4	3	2	1	0
Name	COM4EN	COM3EN	FPGAEN	WDEN				

COM4EN COM4 chip select enable. 1 = enable COM4-CS#. 0 = disable COM4-CS#.

COM3EN COM3 chip select enable. 1 = enable COM3-CS#. 0 = disable COM3-CS#.

FPGEN FPGA chip select enable. 1 = enable FPGA-CS#. 0 = disable FPGA-CS#.

WDEN Watchdog enable. 1 = WDT counter enable. 0 = WDT counter disable, WDO disable, WDI disable, CPURST# disable, EXTSMI# disable.

The CPLD initializes all values to zero on power up. The BIOS then enables each resource based on BIOS settings.

0x25F Read Chip select enable/disable

Bit No.	7	6	5	4	3	2	1	0
Name	COM4EN	COM3EN	FPGAEN	WDEN				

Reads back written values

6.3 Console Redirection to a Serial Port

In many applications without a video card it may be necessary to obtain keyboard and monitor access to the CPU for configuration, file transfer, or other operations. Athena supports this operation by enabling keyboard input and character output onto a serial port (console redirection). A serial port on another PC can be connected to the serial port on Athena with a null modem cable, and a terminal emulation program (such as HyperTerminal) can be used to establish the connection. The terminal program must be capable of transmitting special characters including F2 (some programs or configurations trap special characters).

The default Athena BIOS setting disables console redirection.

There are three possible configurations for console redirection:

- ◆ POST only (default)
- ◆ Always On
- ◆ Disabled

To modify the console redirection settings, enter the BIOS, select the Advanced menu, and then select Console Redirection. In Com Port Address, select Disabled to disable the function, "On-board COM A" for COM1, or "On-board COM B" for COM2.

If you select Disabled, you will not be able to enter BIOS again during power-up through the serial port. To reenter BIOS when console redirection is disabled, you must use a monitor connected to the onboard VGA and a keyboard connected to J3 or remove the CMOS battery jumper to reset the BIOS to the default 'POST only' condition.

More detail on BIOS settings for console redirection can be found on page 31.

6.4 Flash Memory

Athena contains a 2Mbyte 16-bit wide flash memory chip for storage of BIOS and other system configuration data.

6.5 Backup Battery

Athena contains an integrated RTC / CMOS RAM backup battery. The battery is located adjacent to the PC/104 bus connector J1 (within the PC/104 outline). This battery has a capacity of 120mAH and will last over 3 years in power-off state. The on-board battery is activated for the first time during initial factory configuration and test. Note that storage temperature of the board can affect the total battery life. Storage at 23°C is recommended.

6.6 System Reset

Athena contains a chip to control system reset operation. Reset will occur under the following conditions:

- ◆ User causes reset with a ground contact on the Reset input
- ◆ Input voltage drops below 4.75V
- ◆ Over current condition on output power line

The ISA Reset signal is an active high pulse with a duration of 200ms. The internal PCI Reset is active low, with a pulse width duration of 200 msec typical.

6.7 On-Board Video

The on-board video for the Athena board is based on an S3-TwisterT (VIA 8606 "PN133T" Northbridge) video system. As such, the board memory is shared between the Video and main system memory. A block of memory is configured (via BIOS Settings, accessible in the BIOS configuration menus) for video which is then removed from use for main system memory. This implies that the more memory used for the Video, the less memory is available for system resources.

Note that the video memory can be set at 8Mbytes for almost all applications – increasing the memory size will not increase video performance. Additional memory will only benefit the limited 3D support provided by the chipset. Also note that 3D hardware acceleration is not supported across extended temperature range. In general, this 3D hardware is typically only used for 3D games – most likely, these limitations will not affect most embedded applications.

Note that the low-level BIOS can support LCD output in conjunction with standard RGB output (i.e., dual-displays).

7. BIOS

7.1 BIOS Settings

Athena uses a BIOS from Phoenix Technologies modified to support the custom features of the Athena board. Some of these features are described here.

To enter the BIOS during system startup (POST – power on self-test), press F2.

Serial Ports

-The address and interrupt settings for serial ports COM1 and COM2 may be modified. COM1 and COM2 address and interrupt settings are done in the BIOS, Advanced menu, I/O Device Configuration. See page 32 for details.

-The addresses of COM3 and COM4 are fixed. The IRQ selections for COM3 and COM4 are configured on J10.

Select Advanced menu, Advanced Chipset Control, I/O Chip Device Configuration.

Parallel Port

The parallel port is configured in the Advanced -> I/O Chip Device Configuration menu. It is set by default to ECP mode and located at address 0x378, IRQ 7 and DMA 3.

You can move the base address to 0x278 or 0x3BC. The IRQ can be set to 5 or 7. The DMA can be set to 1 or 3.

LCD Video Settings

Athena provides direct digital support for LVDS-based LCD interfaces only. As such, there are two settings that affect this support during BIOS boot:

- Boot Video Device – By default, this is set to “AUTO”. With the AUTO setting, the system will attempt to identify an RGB monitor (via DDC) and, if no RGB monitor is detected then the system enables LCD support. If you wish to use the LCD display regardless of standard monitor connection (i.e., with both connected at once), then set “Boot Video Device” to “Both”.
- Panel Type – This setting defaults to “7”. Do not alter this setting unless specifically instructed to do so. This setting affects the LCD display modes supported; mode “7” is the only setting currently supported. Not all LCD displays are supported.

Miscellaneous

-Memory Cache Settings:

Unless there is a specific reason to change these settings, it is best to keep these settings as-is. Certain system functions (such as USB keyboard support under BIOS menus) may be adversely affected by changes to these settings, due mainly to a heavy reduction in performance. These cache settings can make a huge difference for low-level BIOS calls and, as such, can severely limit performance if they are disabled.

-On the Advanced Chipset Control screen, the following settings should be retained:

Frame Buffer Size: 8MB

AGP Rate: 4X

Expansion Bus Performance: Normal

The Frame Buffer size can be increased for specific applications; just be aware that an increase in this memory size will result in a decrease in overall system memory available. The AGP rate affects internal video accesses and does not affect any external bus speeds.

“Expansion Bus Performance” is an adjustment to allow an increase in ISA I/O Access speeds. For applications where ISA I/O accesses seem to be a limiting factor, this performance may be increased to “Accelerated”. Be aware that increasing these timings may adversely affect system stability with external add-on PC/104 cards. This setting has no direct effect on PCI or memory speeds; it only affects ISA PC/104 devices. It is best to leave this setting at “Normal” if there are no ISA I/O Performance issues.

- On the Advanced screen, the following settings should be retained:

Installed O/S	Win98
Large Disk Access Mode	DOS

- On the On-Chip Multifunction Device screen, the following settings should be retained:

USB Device	Enabled
Legacy Audio	Disabled

“Legacy Audio” will only affect DOS-based applications when used with the VIA-supported DOS Drivers. Enabling this setting will require system I/O, IRQ, and DMA resources. It is strongly recommended that this setting be left “Disabled.”

- On the PCI and ISA Configuration pages (from the Advanced screen), the following setting should be retained:

PCI IRQ Level 1-4	Autoselect for all
PCI/PNP ISA UMB Region Exclusion	Available for all

-The Power Management Screen will only be in effect when under DOS. Otherwise, the OS power management settings will pre-empt these settings. The only power management mode supported by the system is “Power-On Suspend” – other suspend modes are not supported and should not be used under any OS (Examples of unsupported suspend modes: “Hibernate” under Windows and “Suspend-to-Disk” or “Suspend-to-RAM”.)

- The Memory Shadow page of BIOS options should not be modified unless you are certain what you are doing. These settings can adversely affect system performance and, potentially, system reliability.

7.2 BIOS Console Redirection Settings

For applications where the Video interfaces will not be used, the textual feedback typically sent to the monitor can be redirected to a COM PORT. In this manner, a system can be managed and booted without the need for any video connection.

The BIOS allows the following configuration options for Console Redirection to a COM PORT:

- COM PORT Address : Disabled (default), COM PORT A, or COM PORT B
 - **NOTE: IF Console Redirection is enabled here, note that the Associated COM PORT (“A” here referring to COM 1 and “B” referring to COM 2) will be enabled, regardless of the COM PORT settings elsewhere.**
- “Continue CR After POST” : Off (default) or On
 - Determines whether the system is to Wait for CR over COM PORT before continuing (after POST is completed, before OS starts loading)
- Baud Rate : 19.2K (default), 300, 1200, 2400, 9600, 38.4K, 57.6K, 115.2K
- Console Connection : Direct (default) or Modem
- Console Type : PC ANSI (default, VT100, VT100 (8-bit), PC-ANSI (7-bit), VT100+, or VT-UTF8
- Flow Control : CTS/RTS (default), XON-XOFF, None
- # of video Pages to support 1(default) to 8

Note that Console Redirection only works for text-based interaction. If the OS enables video and starts using direct video functions (as would be the case with a Linux X-terminal or Windows, for instance), then Console Redirection will have no effect and video would be required.

8. SYSTEM I/O

8.1 Ethernet

Athena includes a 10/100Mbps Ethernet connection using Cat-5 (100BaseT) wiring. The signals are provided on a 6-pin header (J4) on the right edge of the board.

Diamond Systems' cable no. **698002** mates with the header and provides a standard RJ-45 connector in panel-mount form for connecting to standard Cat5 network cables.

1	Common
2	RX-
3	Common
4	RX+
5	TX-
6	TX+

Table 18: J11 – Ethernet Connector

The Ethernet chip is the National Semiconductor DP83815 MacPhyter chip. It is connected to the system via the board's internal PCI bus.

The Athena Software CD includes Ethernet drivers for Windows 95, Windows 98, Windows NT, and Linux. The latest drivers can also be downloaded from National Semiconductor's website at www.national.com. Search for DP83815 to reach the product folder.

A DOS utility program is provided for testing the chip and accessing the configuration EEPROM. Each board is factory-configured for a unique MAC address using this program. To run the program, you must boot the computer to DOS. The program will not run properly in a DOS window inside of Windows. In normal operation this program should not be required.

Additional software support includes a packet driver with software to allow a full TCP/IP implementation.

8.2 Serial Ports

Athena contains 4 serial ports. Each port is capable of transmitting at speeds of up to 115.2Kbaud. Ports COM1 and COM2 are built into the standard chipset. They consist of standard 16550 type UARTs with 16-byte FIFOs.

Ports COM3 and COM4 are derived from an Exar 16C2850 dual UART chip and include 128-byte FIFOs. Ports 3 and 4 may be operated at speeds up to 460Kbaud with installation of high-speed drivers as a custom option.

The serial ports use the following default system resources:

Port	Address range	IRQ
COM1	I/O 3F8 – 3FF	4
COM2	I/O 2F8 – 2FF	3
COM3	I/O 3E8 – 3EF	9
COM4	I/O 2E8 – 2EF	3

Table 19: COM PORT Default Resource Listing

The settings of COM1 and COM2 may be changed in the system BIOS. Select the Advanced menu, then I/O Device Configuration. The base address and interrupt level may be modified on this page.

The addresses of COM3 and COM4 are fixed. The interrupt (IRQ) settings for COM3 and COM4 are selected with J10. COM3 may use IRQ4 or IRQ9. COM4 may use IRQ3 or IRQ15. See page 20 for serial port IRQ jumper settings. Note that once these jumper selections are made, the user must update the Serial Port IRQ settings to match these selections – the IRQ settings are NOT autodetected in the same manner that the address settings are.

8.3 PS/2 Ports

Athena supports 2 PS/2 ports: one dedicated for keyboard and the other dedicated for mouse function. The two PS/2 ports are accessible via a cable assembly (DSC#**C-PRZ-01**) attached to J3. Support for these ports is independent of, and in addition to, mouse and keyboard support via the USB ports.

8.4 USB Ports

Athena contains 4 USB Ports (referenced as “USB0” through “USB3”). All four USB ports are accessible via cable assemblies attached to J5 (“USB0” and “USB1”) and J21 (“USB2” and “USB3”).

USB support is intended primarily for the following devices (although any USB1.1-standard device should function without issue):

- Keyboards
- Mice
- USB Floppy Drive (NOTE : this is required for “Crisis Recovery” of boot ROM)
- USB flash disks

The BIOS fully supports the USB keyboard during BIOS initialization screens, as well as legacy emulation for DOS-based applications.

The USB ports can be used for keyboards and mice at the same time that the PS/2 keyboard and mouse are plugged in – multiple devices of the same type are supported, although this can get rather confusing.

9. NOTES ON OPERATING SYSTEMS AND BOOTING PROCEDURES

9.1 Windows Operating Systems Installation Issues

Installation of Windows operating systems (Win98/2000/XP) should follow the sequence below. If the sequence is not followed certain drivers might not work and may prevent the device from functioning properly under Windows.

- 1) Enable CD-ROM support in the BIOS. Change boot sequence in BIOS so system boots from CD-ROM first.
- 2) Insert Windows installation CD into CD-ROM and restart computer
- 3) Follow the instructions for installing Windows.

9.1.1 DRIVER INSTALLATION

- 4) Install the Via "4-in-1" driver first. Install driver v4.35 for Windows 98, v4.40 or later for Windows 2000/XP. During installation select the following options:
 - a. Normal Install
 - b. Select the following four options
 - i. VIA ATAPI Vendor Support Driver
 - ii. AGP VxD Driver
 - iii. IRQ Routing Miniport Driver
 - iv. VIA INF Driver v1.40a
 - c. Install VIA ATAPI Vendor Support Driver
 - d. Enable DMA Mode
 - e. Install VIA AGP VXD in Turbo Mode
 - f. Install VIA IRQ Routing Miniport Driver
- 5) Now install the Via/S3 Video driver. Follow installation instructions.
- 6) Install the Via Sound driver. Make sure the sound driver is ComboAudio v3.90 or later
- 7) Install the National Semiconductors Network driver.
- 8) The USB driver for the floppy drive needs to be loaded before the USB floppy drive will be functional under Windows (legacy support will provide floppy access for DOS boot).

9.1.2 BIOS SETTINGS FOR WINDOWS

- "OS" Setting : When using any version of Windows, the "Operating System" selection in the BIOS setup menus should be set to "Win98".
- "Audio" Setting : "Legacy Audio" must be disabled for Windows to boot properly.

9.2 DOS Operating Systems Installation Issues

Installation of DOS operating systems (MS-DOS, FreeDOS, ROM-DOS) should follow the sequence below.

- 1) Enable the following in BIOS:
 - a. Floppy Drive detection.
 - b. Legacy USB support.
- 2) Change BIOS boot sequence so system boots through USB floppy drive.
- 3) Insert DOS installation floppy disk into USB floppy drive and start/restart system.
- 4) Install various drivers needed.

Note : For DOS Ethernet to work, in BIOS set "Operating System" to "other". DOS Sound emulation currently is not functional.

10. DATA ACQUISITION CIRCUIT – I/O MAP AND REGISTER DESCRIPTIONS

Models ATH400-128 and ATH660-128 contain a data acquisition subsystem consisting of A/D, D/A, digital I/O, and counter/timer features. This subsystem is equivalent to a complete add-on data acquisition module.

The A/D section includes a 16-bit A/D converter, 16 input channels, and a 48-sample FIFO. Input ranges are programmable, and the maximum sampling rate is 100KHz. The D/A section includes 4 12-bit D/A channels. The digital I/O section includes 24 lines with programmable direction. The counter/timer section includes a 24-bit counter/timer to control A/D sampling rates and a 16-bit counter/timer for user applications.

High-speed A/D sampling is supported with interrupts and a FIFO. The FIFO is used to store a user-selected number of samples, and the interrupt occurs when the FIFO reaches this threshold. Once the interrupt occurs, an interrupt routine runs and reads the data out of the FIFO. In this way the interrupt rate is reduced by a factor equal to the size of the FIFO threshold, enabling a faster A/D sampling rate. The circuit can operate at sampling rates of up to 100KHz, with an interrupt rate of 6.6-10KHz.

The A/D circuit uses the default settings of I/O address range 280h – 28Fh (base address 280) and IRQ 5. These settings can be changed if needed. The I/O address range is changed in the BIOS, and the interrupt level is changed with jumper block J10.

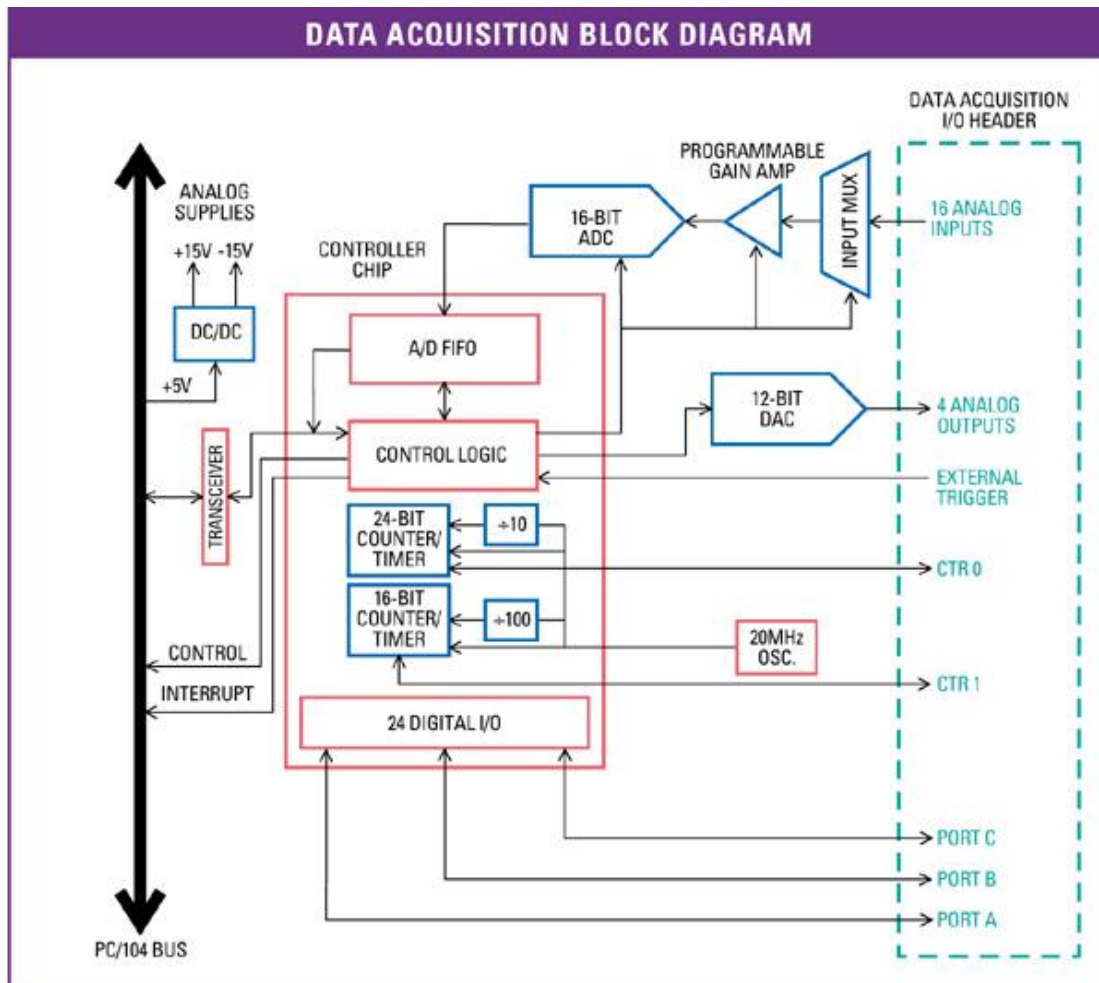

10.1 Base Address

The data acquisition circuitry on Athena occupies a block of 16 bytes in I/O memory space. The default address range for this block is 280h – 28Fh (base address 280).

The data acquisition FPGA can be enabled/disabled in the BIOS under the Advanced menu. Scroll down to the “FPGA Mode:” option and select “Enabled” or “Disabled” accordingly. If the FPGA is disabled you will not be able to interact with the data acquisition circuit.

The FPGA can be enabled or disabled programmatically through the CPLD. More information is on page 26.

A functional list of registers is provided below, and detailed bit definitions are provided on the next page and in the following chapter.

Base +	Write Function	Read Function
0	Command register	A/D LSB
1	Not used	A/D MSB
2	A/D channel register	A/D channel register
3	A/D gain and scan settings	A/D gain and status readback
4	Interrupt / DMA / counter control	Interrupt / DMA / counter control readback
5	FIFO threshold	FIFO threshold readback
6	D/A LSB	FIFO current depth
7	D/A MSB + channel no.	Interrupt and A/D channel readback
8	Digital I/O port A output	Digital I/O port A
9	Digital I/O port B output	Digital I/O port B
10	Digital I/O port C output	Digital I/O port C
11	Digital I/O direction control	Digital I/O direction control readback
12	Counter/timer D7-0	Counter/timer D7-0
13	Counter/timer D15-8	Counter/timer D15-8
14	Counter/timer D23-16	Counter/timer D23-16
15	Counter/timer control register	FPGA revision code

10.2 Data Acquisition Circuit Register Map

WRITE (Blank bits are unused and have no effect)

Address	7	6	5	4	3	2	1	0
0	STRTAD	RSTBRD	RSTDA	RSTFIFO	CLRDMA	CLRT	CLRD	CLRA
1								
2	H3	H2	H1	H0	L3	L2	L1	L0
3						SCANEN	G1	G0
4	CKSEL1	CKFRQ1	CKFRQ0	ADCLK	DMAEN	TINTE	DINTE	AINTE
5			FT5	FT4	FT3	FT2	FT1	FT0
6	DA7	DA6	DA5	DA4	DA3	DA2	DA1	DA0
7	DACH1	DACH0			DA11	DA10	DA9	DA8
8	PA7	PA6	PA5	PA4	PA3	PA2	PA1	PA0
9	PB7	PB6	PB5	PB4	PB3	PB2	PB1	PB0
10	PC7	PC6	PC5	PC4	PC3	PC2	PC1	PC0
11	DIOCTR			DIRA	DIRCH		DIRB	DIRCL
12	CTRD7	CTRD6	CTRD5	CTRD4	CTRD3	CTRD2	CTRD1	CTRD0
13	CTRD15	CTRD14	CTRD13	CTRD12	CTRD11	CTRD10	CTRD9	CTRD8
14	CTRD23	CTRD22	CTRD21	CTRD20	CTRD19	CTRD18	CTRD17	CTRD16
15	CTRNO	LATCH	GTDIS	GTEN	CTDIS	CTEN	LOAD	CLR

READ (Blank bits are unused and read back as 0)

Address	7	6	5	4	3	2	1	0
0	AD7	AD6	AD5	AD4	AD3	AD2	AD1	AD0
1	AD15	AD14	AD13	AD12	AD11	AD10	AD9	AD8
2	H3	H2	H1	H0	L3	L2	L1	L0
3	STS	SD	WAIT	DACBSY	OVF	SCANEN	G1	G0
4	CKSEL1	CKFRQ1	CKFRQ0	ADCLK	DMAEN	TINTE	DINTE	AINTE
5			FT5	FT4	FT3	FT2	FT1	FT0
6			FD5	FD4	FD3	FD2	FD1	FD0
7	DMAINT	TINT	DINT	AINTE	ADCH3	ADCH2	ADCH1	ADCH0
8	PA7	PA6	PA5	PA4	PA3	PA2	PA1	PA0
9	PB7	PB6	PB5	PB4	PB3	PB2	PB1	PB0
10	PC7	PC6	PC5	PC4	PC3	PC2	PC1	PC0
11	DIOCTR			DIRA	DIRCH		DIRB	DIRCL
12	CTRD7	CTRD6	CTRD5	CTRD4	CTRD3	CTRD2	CTRD1	CTRD0
13	CTRD15	CTRD14	CTRD13	CTRD12	CTRD11	CTRD10	CTRD9	CTRD8
14	CTRD23	CTRD22	CTRD21	CTRD20	CTRD19	CTRD18	CTRD17	CTRD16
15	REV7	REV6	REV5	REV4	REV3	REV2	REV1	REV0

10.3 Register Bit Definitions

In these register definitions, a bit marked 'X' is an unused bit.

All unused bits in readable registers read back as 0.

Base + 0 Write Command Register

Bit No.	7	6	5	4	3	2	1	0
Name	STRTAD	RSTBRD	RSTDA	RSTFIFO	CLRDMA	CLRT	CLRD	CLRA

This register is used to perform various functions. The register bits are not data bits but instead command triggers. Each function is initiated by writing a 1 to a particular bit. **Writing a 1 to any bit in this register does not affect any other bit in this register.** For example, to reset the FIFO, write the value 0x10 (16) to this register to write a 1 to bit 4. No other function of the register will be performed. Multiple actions can be carried out simultaneously by writing a 1 to multiple bits simultaneously.

STRTAD Start an A/D conversion (trigger the A/D) when in software-trigger mode (AINTE = 0). Once the program writes to this bit, the A/D conversion will start and the STS bit (base + 3 bit 7) will go high. The program should then monitor STS and wait for it to go low (check if value in base + 3 is less than 128 or 0x80). When it goes low the A/D data at Base + 0 and Base + 1 may be read.

When AINTE = 1 (base + 4 bit 0), the A/D cannot be triggered by writing to this bit. Instead the A/D will be triggered by a signal selected by ADCLK in base + 4 bit 5.

RSTBRD Reset the entire board excluding the D/A. Writing a 1 to this bit causes all registers on the board to be reset to 0. The effect on the digital I/O is that all ports are reset to input mode, and the logic state of their pins will be determined by the pull-up/pull-down configuration setting selected by the user. All A/D, counter/timer, interrupt, and DMA functions will cease. However the D/A values will remain constant.

RSTDA Reset the 4 analog outputs. The analog outputs will be reset to either mid-scale or zero-scale, depending on the jumper configuration selected by the user. A separate reset is provided for the D/A so that the user may reset the board if needed without affecting the circuitry connected to the analog outputs.

RSTFIFO Reset the FIFO depth to 0. This clears the FIFO so that further A/D conversions will be stored in the FIFO starting at address 0.

CLRDMA Writing a 1 to this bit causes the DMA interrupt request flip flop to be reset.

CLRT Writing a 1 to this bit causes the timer interrupt request flip flop to be reset.

CLRD Writing a 1 to this bit causes the digital I/O interrupt request flip flop to be reset.

CLRA Writing a 1 to this bit causes the analog interrupt request flip flop to be reset.

The user's interrupt routine must write to the appropriate bit prior to exiting in order to enable future interrupts. Otherwise the interrupt line will stay high indefinitely and no additional interrupt requests will be generated by the board.

Base + 0 Read A/D LSB

Bit No.	7	6	5	4	3	2	1	0
Name	AD7	AD6	AD5	AD4	AD3	AD2	AD1	AD0

AD7 - 0 A/D data bits 7 - 0; AD0 is the LSB; A/D data is an unsigned 16-bit value.

The A/D value is derived by reading two bytes from Base + 0 and Base + 1 and applying the following formula:

$$\text{A/D value} = (\text{Base} + 0 \text{ value}) + (\text{Base} + 1 \text{ value}) * 256$$

The value is interpreted as a two's complement 16-bit number ranging from -32768 to +32767. This raw A/D value must then be converted to the corresponding input voltage and/or the engineering units represented by that voltage by applying additional application-specific formulas. Both conversions (conversion to volts and then conversion to engineering units) may be combined into a single formula for efficiency.

Base + 1 Write Not Used

Base + 1 Read A/D MSB

Bit No.	7	6	5	4	3	2	1	0
Name	AD15	AD14	AD13	AD12	AD11	AD10	AD9	AD8

AD15 - 8 A/D data bits 15 – 8; AD15 is the MSB; A/D data is an unsigned 16-bit value.

See Base + 0 Read on the previous page for information on A/D values and formulas.

Base + 2 Read/Write A/D Channel Register

Bit No.	7	6	5	4	3	2	1	0
Name	H3	H2	H1	H0	L3	L2	L1	L0

H3 – H0 High channel of channel scan range
Ranges from 0 to 15 in single-ended mode, 0 - 7 in differential mode.

L3 - L0 Low channel of channel scan range
Ranges from 0 to 15 in single-ended mode, 0 - 7 in differential mode.

The high channel must be greater than or equal to the low channel.

When this register is written, the current A/D channel is set to the low channel, so that the next time an A/D conversion is triggered the low channel will be sampled.

When this register is written to, the WAIT bit (Read Base + 3 bit 5) will go high for 10 microseconds to indicate that the analog input circuit is settling. During this time an A/D conversion should not be performed because the data will be inaccurate.

After writing a new gain setting (Base + 3), the WAIT bit is also set, and the program must monitor it prior to starting an A/D conversion.

The channel and gain registers can be written to in succession without waiting for the intervening WAIT signal. Only one WAIT period must be observed between the last triggering condition (write to Base + 2 or Base + 3) and the start of an A/D conversion.

The A/D circuit is designed to automatically increment the A/D channel each time a conversion is generated. This enables the user to avoid having to write the A/D channel each time. The A/D channel will rotate through the values between LOW and HIGH. For example, if LOW = 0 and HIGH = 3, the A/D channels will progress through the following sequence: 0, 1, 2, 3, 0, 1, 2, 3, 0, 1,

Reading from this register returns the value previously written to it.

Base + 3 Write Analog Input Gain

Bit No.	7	6	5	4	3	2	1	0
Name	X	X	X	X	X	SCANEN	G1	G0

SCANEN Scan mode enable:

1 Each A/D trigger will cause the board to generate an A/D conversion on each channel in the range LOW – HIGH (the range is set with the channel register in Base + 2).

The STS bit (read Base + 3 bit 7) stays high during the entire scan.

0 Each A/D trigger will cause the board to generate a single A/D conversion on the current channel. The internal channel pointer will increment to the next channel in the range LOW – HIGH or reset to LOW if the current channel is HIGH.

The STS bit stays high during the A/D conversion.

G1-G0 Analog input gain. The gain is the ratio of the voltage seen by the A/D converter and the voltage applied to the input pin. The gain setting is the same for all input channels.

When this register is written to, the WAIT bit (Read Base + 3 bit 6) will go high for 10 microseconds to indicate that the analog input circuit is settling. During this time an A/D conversion should not be performed because the data will be inaccurate. After writing a new gain setting, the program should monitor the WAIT bit prior to starting an A/D conversion.

After writing a new channel selection (Base + 2), the WAIT bit is also set, and the program must monitor it prior to starting an A/D conversion.

The channel and gain registers can be written to in succession without waiting for the intervening WAIT signal. Only one WAIT period must be observed between the last triggering condition (write to Base + 2 or Base + 3) and the start of an A/D conversion.

The following table lists the possible analog input ranges:

G1	G0	Gain	Unipolar Range	Bipolar Range
0	0	1	Invalid	±10V
0	1	2	0-8.3V	±5V
1	0	4	0-5V	±2.5V
1	1	8	0-2.5V	±1.25V

Base + 3 Read Analog Input Status

Bit No.	7	6	5	4	3	2	1	0
Name	STS	SD	WAIT	DACBSY	OVF	SCANEN	G1	G0

- STS** A/D status. 1 = A/D conversion or scan in progress, 0 = A/D is idle.
 If SCANEN = 0 (single conversion mode), STS goes high when an A/D conversion is started and stays high until the conversion is finished. If SCANEN = 1 (scan mode enabled), STS stays high during the entire scan. After starting a conversion in software, the program must monitor STS and wait for it to become 0 prior to reading A/D values from Base + 0 and Base + 1.
- SD** Single-ended / Differential mode indicator. 1 = SE, 0 = DI.
- WAIT** A/D input circuit status. 1 = A/D circuit is settling on a new value, 0 = ok to start conversion.
 WAIT goes high after the channel register (Base + 2) or the gain register (Base + 3) is changed. It stays high for 9 microseconds. The program should monitor this bit after writing to either register and wait for it to become 0 prior to starting an A/D conversion.
- DACBSY** Indicates the DAC is busy updating (approx. 30 μ S). 1 = Busy, 0 = Idle. Do not attempt to write to the DAC (registers 6 and 7) while DACBSY = 1.
- OVF** FIFO Overflow bit. This bit indicates that the FIFO has overflowed, meaning that the A/D circuit has attempted to write data to it when it is full. This condition occurs when data is written into the FIFO faster than it is read out.
 When overflow occurs, the FIFO will not accept any more data until it is reset. The OVF condition is sticky, meaning that it remains true until the FIFO is reset, so the application program will be able to determine if overflow occurs. If overflow occurs, then you must either reduce the sample rate or increase the efficiency of your interrupt routine and/or operating system.
- SCANEN** Scan mode readback (see Base + 3 Write above).
- G1-G0** A/D gain setting readback (see Base + 3 Write above).

Base + 4 Read/Write Interrupt / DMA / Counter Control

Bit No.	7	6	5	4	3	2	1	0
Name	CKSEL1	CKFRQ1	CKFRQ0	ADCLK	DMAEN	TINTE	DINTE	AINTE

- CKSEL1 Clock source selection for counter/timer 1:
0 = internal oscillator, frequency selected by CLKFRQ1
1 = external clock input CLK1 (DIO C pins must be set for ctr/timer signals)
- CKFRQ1 Input frequency selection for counter/timer 1 when CKSEL1 = 1:
0 = 10MHz, 1 = 100KHz
- CKFRQ0 Input frequency selection for counter/timer 0.
0 = 10MHz, 1 = 1MHz
- ADCLK A/D trigger select when AINTE = 1:
0 = internal clock output from counter/timer 0
1 = external clock input EXTTRIG
- DMAEN Enable DMA operation. 1 = enable, 0 = disable.
- TINTE Enable timer interrupts. 1 = enable, 0 = disable.
- DINTE Enable digital I/O interrupts. 1 = enable, 0 = disable.
- AINTE Enable analog input interrupts. 1 = enable, 0 = disable.
- NOTE:** When AINTE = 1, the A/D cannot be triggered by writing to Base + 0.

Analog output interrupts are not supported on this board.

Multiple interrupt operations may be performed simultaneously. All interrupts will be on the same interrupt level. The user's interrupt routine must monitor the status bits to know which circuit has requested service. After processing the data but before exiting, the interrupt routine must then clear the appropriate interrupt request bit using the register at Base + 0.

Base + 5 Read/Write FIFO Threshold

Bit No.	7	6	5	4	3	2	1	0
Name	X	X	FT5	FT4	FT3	FT2	FT1	FT0

- FT5–0 FIFO threshold. When the number of A/D samples in the FIFO reaches this number, the board will generate an interrupt and set AINT high (Base + 7 bit 4). The interrupt routine is responsible for reading the correct number of samples out of the FIFO.
- The valid range is 1-48. If the value written is greater than 48, then 48 will be used. If the value written is 0, then 1 will be used. The interrupt rate is equal to the total sample rate divided by the FIFO threshold. Generally, for higher sampling rates a higher threshold should be used to reduce the interrupt rate. However remember that the higher the FIFO threshold, the smaller the amount of FIFO space remaining to store data while waiting for the interrupt routine to respond. If you get a FIFO overflow condition, you must lower the FIFO threshold and/or lower the A/D sampling rate.

Base + 6 Write DAC LSB

Bit No.	7	6	5	4	3	2	1	0
Name	DA7	DA6	DA5	DA4	DA3	DA2	DA1	DA0

DA7–0 D/A data bits 7 - 0; DA0 is the LSB. D/A data is an unsigned 12-bit value. This register must be written to before Base + 7, since writing to Base + 7 updates the DAC immediately.

Base + 6 Read A/D Channel and FIFO Status

Bit No.	7	6	5	4	3	2	1	0
Name	0	0	FD5	FD4	FD3	FD2	FD1	FD0

FD5–0 Current FIFO depth. This value indicates the number of A/D values currently stored in the FIFO.

Base + 7 Write DAC MSB + Channel No.

Bit No.	7	6	5	4	3	2	1	0
Name	DACH1	DACH0	X	X	DA11	DA10	DA9	DA8

DACH1–0 D/A channel. The value written to Base + 6 and Base + 7 are written to the selected channel, and that channel is updated immediately. The update takes approximately 20 microseconds due to the DAC serial interface.

DA11–8 D/A bits 11 - 8; DA11 is the MSB. D/A data is an unsigned 12-bit value.

Base + 7 Read Analog Operation Status

Bit No.	7	6	5	4	3	2	1	0
Name	DMAINT	TINT	DINT	AINT	ADCH3	ADCH2	ADCH1	ADCH0

DMAINT DMA interrupt status. 1 = interrupt pending, 0 = interrupt not pending.

TINT Timer interrupt status, same values as above.

DINT Digital I/O interrupt status, same values as above.

AINT Analog input interrupt status, same values as above.

ADCH3-0 Current A/D channel. This is the channel that will be sampled on the **next** conversion.

When any of bits 7–4 are 1, the corresponding circuit is requesting service. The interrupt routine must poll these bits to determine which circuit needs service and then act accordingly.

Base + 8 Read / Write Digital I/O Port A

Bit No.	7	6	5	4	3	2	1	0
Name	A7	A6	A5	A4	A3	A2	A1	A0

Base + 9 Read / Write Digital I/O Port B

Bit No.	7	6	5	4	3	2	1	0
Name	B7	B6	B5	B4	B3	B2	B1	B0

Base + 10 Read / Write Digital I/O Port C

Bit No.	7	6	5	4	3	2	1	0
Name	C7	C6	C5	C4	C3	C2	C1	C0

These 3 registers are used for digital I/O. The direction of each register is controlled by bits in the register below.

Base + 11 Read / Write Digital I/O Control Register

Bit No.	7	6	5	4	3	2	1	0
Name	DIOCTR	X	X	DIRA	DIRCH	X	DIRB	DIRCL

The bit assignments of this register are designed to be compatible with the 82C55 chip's control register.

DIOCTR Selects counter I/O signals or digital I/O lines C4-C7 on pins 21-24 of J14:

Pin No.	DIOCTR = 1	DIOCTR = 0	Pin direction for DIOCTR = 0
21	C4	Gate 0	Input
22	C5	Gate 1	Input
23	C6	Clk 1	Input
24	C7	Out 0	Output

NOTE: If DIOCTR = 0, then the pin direction is as shown above. If DIOCTR = 1 then the pin direction is controlled by DIRCH.

This bit resets to 1.

DIRA Port A direction. 0 = output, 1 = input

DIRB Port B direction: 0 = output, 1 = input

DIRCH Port C bits 7-4 direction: 0 = output, 1 = input

DIRCL Port C bits 3-0 direction: 0 = output, 1 = input

Base + 12 Read/Write Counter/Timer D7 - 0

Bit No.	7	6	5	4	3	2	1	0
Name	D7	D6	D5	D4	D3	D2	D1	D0

This register is used for both Counter 0 and Counter 1. It is the LSB for both counters.

When writing to this register, an internal load register is loaded. Upon issuing a Load command through Base + 15, the selected counter's LSB register will be loaded with this value.

When reading from this register, the LSB value of the most recent Latch command will be returned. The value returned is NOT the value written to this register.

Base + 13 Read/Write Counter/Timer D15 - 8

Bit No.	7	6	5	4	3	2	1	0
Name	D15	D14	D13	D12	D11	D10	D9	D8

This register is used for both Counter 0 and Counter 1. It is the MSB for counter 1 and the middle byte for counter 0.

When writing to this register, an internal load register is loaded. Upon issuing a Load command through Base + 15, the selected counter's associated register will be loaded with this value. For counter 0, it is the middle byte. For counter 1, it is the MSB.

When reading from this register, the associated byte of the most recent Latch command will be returned. The value returned is NOT the value written to this register.

Base + 14 Read/Write Counter/Timer D23 - 16

Bit No.	7	6	5	4	3	2	1	0
Name	D23	D22	D21	D20	D19	D18	D17	D16

This register is used for Counter 0 only. Counter 0 is 24 bits wide, while Counter 1 is only 16 bits wide.

When writing to this register, an internal load register is loaded. Upon issuing a Load command through Base + 15 for Counter 0, the counter's MSB register will be loaded with this value. When issuing a Load command for counter 1, this register is ignored.

When reading from this register, the MSB value of the most recent Latch command for counter 0 will be returned. The value returned is NOT the value written to this register.

Base + 15 Write Counter/Timer Control Register

Bit No.	7	6	5	4	3	2	1	0
Name	CTRNO	LATCH	GTDIS	GTEN	CTDIS	CTEN	LOAD	CLR

This register is used to control the counter/timers. A counter is selected with bit 7, and then a 1 is written to any ONE of bits 6 – 0 to select the desired operation for that counter. The other bits and associated functions are not affected. Thus only one operation can be performed at a time.

- CTRNO Counter no., 0 or 1
- LATCH Latch the selected counter so that its value may be read. The counter must be latched before it is read. Reading from registers 12-14 returns the most recently latched value. If you are reading Counter 1 data, read only Base + 12 and Base + 13. Any data in Base + 14 will be from the previous Counter 0 access.
- GTDIS Disable external gating for the selected counter.
- GTEN Enable external gating for the selected counter. If enabled, the associated gate signal GATE0 or GATE1 controls counting on the counter. If the GATEn signal is high, counting is enabled. If the GATEn signal is low, counting is disabled.
- CTDIS Disable counting on the selected counter. The counter will ignore input pulses.
- CTEN Enable counting on the selected counter. The counter will decrement on each input pulse.
- LOAD Load the selected counter with the data written to Base + 12 through Base + 14 or Base + 12 and Base + 13 (depending on which counter is being loaded).
- CLR Clear the current counter (set its value to 0).

To load a counter: First write the load value to Base + 12 and Base + 13 (for Counter 1) or Base + 12 through Base + 14 (for Counter 0). Then write a Load command to Base + 15. For example, to load Counter 0 with the hex value 123456:

- ◆ Write 0x12 to Base + 14 (these three bytes can be written to in any order)
- ◆ Write 0x34 to Base + 13
- ◆ Write 0x56 to Base + 12
- ◆ Write 0x02 to Base + 15 to load counter 0

To enable counting: Write 0x04 (ctr 0) or 0x84 (ctr 1) to Base + 15.

To stop counting: Write 0x08 (ctr 0) or 0x88 (ctr 1) to Base + 15.

To read a counter: First latch it, then read the value:

- ◆ Write 0x40 to Base + 15 to latch counter 0 or 0xC0 to latch counter 1
- ◆ Read LSB from Base +12
- ◆ Read Middle Byte from Base + 13
- ◆ Read MSB from Base + 14
- ◆ Assemble 3 bytes into the current counter value

More complete counter programming operations are provided in chapter 18 on page 63.

Base + 15 Read FPGA Revision Code

Bit No.	7	6	5	4	3	2	1	0
Name	REV7	REV6	REV5	REV4	REV3	REV2	REV1	REV0

This register is used to control the counter/timers. A counter is selected with bit 7, and then a 1 is written to any ONE of bits 6 – 0 to select the desired operation for that counter. The other bits and associated functions are not affected. Thus only one operation can be performed at a time.

REV7-0 Revision code, read as a 2-digit hex value, i.e. 0x20 = revision 2.0

11. ANALOG-TO-DIGITAL INPUT RANGES AND RESOLUTION

11.1.1 OVERVIEW

Athena uses a 16-bit A/D converter. The full range of numerical values for a 16-bit number is 0 - 65535. However the A/D converter uses twos complement notation, so the A/D value is interpreted as a signed integer ranging from -32768 to +32767.

The smallest change in input voltage that can be detected is $1/(2^{16})$, or 1/65536, of the full-scale input range. This smallest change results in an increase or decrease of 1 in the A/D code, and so this change is referred to as 1 LSB, or 1 Least Significant Bit.

The analog inputs on Athena have three configuration options:

- ◆ Single-ended or differential mode
- ◆ Unipolar or bipolar mode
- ◆ Input range (gain)

The single-ended / differential and unipolar / bipolar configuration is done with a jumper on jumper block J13 (see page 23), and the input range selection is done in software.

11.2 Input Range Selection

Athena can be configured to measure both unipolar (positive only) and bipolar (positive and negative) analog voltages. This configuration is done with a jumper and applies to all inputs. In addition you can select a gain setting for the inputs, which causes them to be amplified before they reach the A/D converter. The gain setting is controlled in software, so it can be changed on a channel-by-channel basis. In general you should select the highest gain (smallest input range) that will allow the A/D converter to read the full range of voltages over which your input signals will vary. However, if you pick too high a gain, then the A/D converter will clip at either the high end or low end, and you will not be able to read the full range of voltages on your input signals.

11.3 Input Range Table

The table below indicates the analog input range for each possible configuration. The polarity is set with a jumper on jumper block J13, and the gain is set with the G1 and G0 bits in the register at Base + 3. The Gain value in the table is provided for clarity. Note that the single-ended vs. differential setting has no impact on the input range or the resolution.

Polarity	G1	G0	Input Range	Resolution (1 LSB)
Bipolar	0	0	±10V	305µV
Bipolar	0	1	±5V	153µV
Bipolar	1	0	±2.5V	76µV
Bipolar	1	1	±1.25V	38µV
Unipolar	0	0	--- Invalid ---	
Unipolar	0	1	0 – 8.3V	153µV
Unipolar	1	0	0 – 5V	76µV
Unipolar	1	1	0 – 2.5V	38µV

Table 20: Data Acquisition : Analog Input Range

12. PERFORMING AN A/D CONVERSION

This chapter describes the steps involved in performing an A/D conversion on a selected input channel using direct programming (not with the driver software).

There are seven steps involved in performing an A/D conversion:

1. **Select the input channel**
2. **Select the input range**
3. **Wait for analog input circuit to settle**
4. **Initiate an A/D conversion**
5. **Wait for the conversion to finish**
6. **Read the data from the board**
7. **Convert the numerical data to a meaningful value**

12.1 Select the input channel

To select the input channel to read, write a low-channel/high-channel pair to the channel register at base + 2 (see page 41). The low 4 bits select the low channel, and the high 4 bits select the high channel. When you write any value to this register, the current A/D channel is set to the low channel.

For example:

To set the board to channel 4 only, write 0x44 to Base + 2.

To set the board to read channels 0 through 15, write 0xF0 to Base + 2.

⇒ **Note:** When you perform an A/D conversion, the current channel is automatically incremented to the next channel in the selected range. Therefore, to perform A/D conversions on a group of consecutively-numbered channels, you do not need to write the input channel prior to each conversion. For example, to read from channels 0 - 2, write Hex 20 to base + 2. The first conversion is on channel 0, the second will be on channel 1, and the third will be on channel 2. Then the channel counter wraps around to the beginning again, so the fourth conversion will be on channel 0 again and so on.

If you are sampling the same channel repeatedly, then you set both high and low to the same value as in the first example above. Then on subsequent conversions you do not need to set the channel again.

12.2 Select the input range

Select the input range from among the available ranges shown on page 51. If the range is the same as for the previous A/D conversion then it does not need to be set again. Write this value to the input range register at Base + 3 (see page 42).

For example:

For $\pm 5V$ range (gain of 2), write 0x01 to Base + 3.

12.3 Wait for analog input circuit to settle

After writing to either the channel register (Base + 2) or the input range register (Base + 3), you must allow time for the analog input circuit to settle before starting an A/D conversion. The board has a built-in 10 μ S timer to assist with the wait period. Monitor the WAIT bit at Base + 3 bit 5. When it is 1 the circuit is actively settling on the input signal. When it is 0 the board is ready to perform A/D conversions.

12.4 Perform an A/D conversion on the current channel

After the above steps are completed, start the A/D conversion by writing to Base + 0. This write operation only triggers the A/D if AINTE = 0 (interrupts are disabled). When AINTE = 1, the A/D can only be triggered by the on-board counter/timer or an external signal. This protects against accidental triggering by software during a long-running interrupt-based acquisition process.

```
outp(base,0x80);
```

12.5 Wait for the conversion to finish

The A/D converter chip takes up to 5 microseconds to complete one A/D conversion. Most processors and software can operate fast enough so that if you try to read the A/D converter immediately after starting the conversion, you will beat the A/D converter and get invalid data. Therefore the A/D converter provides a status signal to indicate whether it is busy or idle. This bit can be read back as bit 7 in the status register at Base + 3. When the A/D converter is busy (performing an A/D conversion), this bit is 1 and the program must wait. When the A/D converter is idle (conversion is done and data is available), this bit is 0 and the program may read the data. Here are examples:

```
while (inp(base+3) & 0x80); // Wait for conversion to finish before proceeding
```

This method could hang your program if there is a hardware fault and the bit is stuck at 1. Better is to use a loop with a timeout:

```
int checkstatus() // returns 0 if ok, -1 if error
int i;
for (i = 0; i < 10000; i++)
{
    if !(inp(base+3) & 0x80) then return(0); // conversion completed
}
return(-1); // conversion didn't complete
```

12.6 Read the data from the board

Once the conversion is complete, you can read the data back from the A/D converter. The data is a 16-bit value and is read back in two 8-bit bytes. The LSB must be read from the board before the MSB, because the data is inserted into the board's FIFO in that order. Unlike other registers on the board, the A/D data may only be read one time, since each time a byte is read from the FIFO, the FIFO's internal pointer advances, and that byte is no longer available. Note that reading data from an empty FIFO returns unpredictable results.

The following pseudo-code illustrates how to read and construct the 16-bit A/D value:

```
LSB = inp(base);
MSB = inp(base+1);
Data = MSB * 256 + LSB; // combine the 2 bytes into a 16-bit value
```

The final data is interpreted as a 16-bit signed integer ranging from -32768 to +32767.

⇒ **Note:** The data range always includes both positive and negative values, even if the board is set to a unipolar input range. The data must now be converted to volts or other engineering units by using a conversion formula as shown on the next page.

In scan mode, the behavior is the same except that when the program initiates a conversion, all channels in the programmed channel range will be sampled once, and the data will be stored in the FIFO. The FIFO depth register will increment by the scan size. When STS goes low, the program should read out the data for all channels.

12.7 Convert the numerical data to a meaningful value

Once you have the A/D value, you need to convert it to a meaningful value. The first step is to convert it back to the actual measured voltage. Afterwards you may need to convert the voltage to some other engineering units (for example, the voltage may come from a temperature sensor, and then you would need to convert the voltage to the corresponding temperature according to the temperature sensor's characteristics).

Since there are a large number of possible input devices, this secondary step is not included here; only conversion to input voltage is described. However you can combine both transformations into a single formula if desired.

To convert the A/D value to the corresponding input voltage, use the following formulas:

Conversion Formula for Bipolar Input Ranges

Input voltage = A/D value / 32768 * Full-scale input range

Example: Input range is $\pm 5V$ and A/D value is 17761:
 Input voltage = $17761 / 32768 * 5V = 2.710V$

For a bipolar input range, $1 \text{ LSB} = 1/32768 * \text{Full-scale voltage}$.

Here is an illustration of the relationship between A/D code and input voltage for a bipolar input range (V_{FS} = Full scale input voltage):

<u>A/D Code</u>	<u>Input voltage symbolic formula</u>	<u>Input voltage for $\pm 5V$ range</u>
-32768	$-V_{FS}$	-5.0000V
-32767	$-V_{FS} + 1 \text{ LSB}$	-4.9998V
...
-1	-1 LSB	-0.00015V
0	0	0.0000V
1	$+1 \text{ LSB}$	0.00015V
...
32767	$V_{FS} - 1 \text{ LSB}$	4.9998V

Conversion Formula for Unipolar Input Ranges

Input voltage = (A/D value + 32768) / 65536 * Full-scale input range

Example: Input range is 0-5V and A/D value is 17761:
 Input voltage = $(17761 + 32768) / 65536 * 5V = 3.855V$

For a unipolar input range, $1 \text{ LSB} = 1/65536 * \text{Full-scale voltage}$.

Here is an illustration of the relationship between A/D code and input voltage for a unipolar input range (V_{FS} = Full scale input voltage):

<u>A/D Code</u>	<u>Input voltage symbolic formula</u>	<u>Input voltage for 0-5V range</u>
-32768	0V	0.0000V
-32767	$1 \text{ LSB} (V_{FS} / 65536)$	0.000076V
...
-1	$V_{FS} / 2 - 1 \text{ LSB}$	2.4999V
0	$V_{FS} / 2$	2.5000V
1	$V_{FS} / 2 + 1 \text{ LSB}$	2.5001V
...
32767	$V_{FS} - 1 \text{ LSB}$	4.9999V

13. A/D SCAN, INTERRUPT, AND FIFO OPERATION

The control bits SCANEN (scan enable) and AINTE (A/D interrupt enable) in conjunction with the FIFO determine the behavior of the board during A/D conversions and interrupts.

At the end of an AD conversion, the 16-bit A/D data is latched into the 8-bit FIFO in an interleaved fashion, first LSB, then MSB. A/D Data is read out of the FIFO with 2 read operations, first Base + 0 (LSB) and then Base + 1 (MSB).

When SCANEN = 1, each time an A/D trigger occurs, the board will perform an A/D conversion on all channels in the channel range programmed in Base + 2. When SCANEN = 0, each time an A/D trigger occurs, the board will perform a single A/D conversion and then advance to the next channel and wait for the next trigger.

During interrupt operation (AINTE = 1), the FIFO will fill up with data until it reaches the threshold programmed in the FIFO threshold register, and then the interrupt request will occur. If AINTE = 0, the FIFO threshold is ignored and the FIFO continues to fill up.

If the FIFO reaches its limit of 48 samples, then the next time an A/D conversion occurs the Overflow flag OVF will be set. In this case the FIFO will not accept any more data, and its contents will be preserved and may be read out. In order to clear the overflow condition, the program must reset the FIFO by writing to the FIFORST bit in Base + 1, or a hardware reset must occur.

In Scan mode (SCANEN = 1), the FIFO threshold should be set to a number at least equal to the scan size and in all cases equal to an integral number of scans. For example if the scan size is 8 channels, the FIFO threshold should be set to 8, 16, 24, 32, 40, or 48, but not less than 8. This way the interrupt will occur at the end of the scan, and the interrupt routine can read in a complete scan or set of scans each time it runs.

In non-scan mode (SCANEN = 0), the FIFO threshold should be set to a level that minimizes the interrupt rate but leaves enough time for the interrupt routine to respond before the next A/D conversion occurs. Remember that no data is available until the interrupt occurs, so if the rate is slow the delay to receive A/D data may be long. Therefore for slow sample rates the FIFO threshold should be small. If the sample rate is high, the FIFO threshold should be high to reduce the interrupt rate. However remember that the remaining space in the FIFO determines the time the interrupt routine has to respond to the interrupt request. If the FIFO threshold is too high, the FIFO may overflow before the interrupt routine responds. A good rule of thumb is to limit the interrupt rate to no more than 1,000-2,000 per second in Windows and Linux or 10,000 per second in DOS. Experimentation may be necessary to determine the optimum FIFO threshold for each application.

The table on the next page describes the board's behavior for each of the 4 possible cases of AINTE and SCANEN. The given interrupt software behavior describes the operation of the Diamond Systems Universal Driver software. If you write your own software or interrupt routine you should conform to the described behavior for optimum results.

13.1 Athena A/D Operating Modes

The following control bits and values are referenced in the descriptions in the table below.

AINTE	Base + 4 bit 0
SCANEN	Base + 3 bit 2
FIFO threshold	Base + 5 bits 5-0
STS	Base + 3 bit 7
LOW, HIGH	4-bit channel nos. in Base + 2
ADCLK	Base + 4 bit 4

AINTE	SCANEN	Operation
0	0	<ul style="list-style-type: none"> - Single A/D conversions are triggered by write to B+0. - STS stays high during the A/D conversion. - No interrupt occurs. - The user program monitors STS and reads A/D data when it goes low.
0	1	<ul style="list-style-type: none"> - A/D scans are triggered by write to B+0. All channels between LOW and HIGH will be sampled. - STS stays high during the entire scan (multiple A/D conversions). - No interrupt occurs. - The user program monitors STS and reads all A/D values when it goes low.
1	0	<ul style="list-style-type: none"> - Single A/D conversions are triggered by the source selected with ADCLK. - STS stays high during the A/D conversion. - A/D interrupt occurs when the FIFO reaches its programmed threshold. - The interrupt routine reads out a number of samples equal to the FIFO threshold each time it runs.
1	1	<ul style="list-style-type: none"> - A/D scans are triggered by the source selected with ADCLK. - STS stays high during the entire scan (multiple A/D conversions). - A/D interrupt occurs when the FIFO reaches its programmed threshold. - The interrupt routine reads out a number of samples equal to the FIFO threshold each time it runs.

Table 21: A/D Operating Modes

14. ANALOG OUTPUT RANGES AND RESOLUTION

14.1 Description

Athena uses a 4-channel 12-bit D/A converter (DAC) to provide 4 analog outputs. A 12-bit DAC can generate output voltages with the precision of a 12-bit binary number. The maximum value of a 12-bit binary number is $2^{12} - 1$, or 4095, so the full range of numerical values that the DACs support is 0 - 4095. The value 0 always corresponds to the lowest voltage in the output range, and the value 4095 always corresponds to the highest voltage minus 1 LSB (the theoretical top end of the range corresponds to an output code of 4096 which is impossible to achieve).

⇒ **Note:** In this manual, the terms analog output, D/A, and DAC are all used interchangeably to mean the same thing.

14.2 Resolution

The *resolution* is the smallest possible change in output voltage. For a 12-bit DAC the resolution is $1/(2^{12})$, or $1/4096$, of the full-scale output range. This smallest change results from an increase or decrease of 1 in the D/A code, and so this change is referred to as 1 LSB, or 1 least significant bit. The value of this LSB is calculated as follows:

$$1 \text{ LSB} = \text{Output voltage range} / 4096$$

Example: Output range = 0-10V;

$$\text{Output voltage range} = 10\text{V} - 0\text{V} = 10\text{V}$$

$$1 \text{ LSB} = 10\text{V} / 4096 = 2.44\text{mV}$$

Example: Output range = $\pm 10\text{V}$;

$$\text{Output voltage range} = 10\text{V} - (-10\text{V}) = 20\text{V}$$

$$1 \text{ LSB} = 20\text{V} / 4096 = 4.88\text{mV}$$

14.3 Output Range Selection

Jumper block J13 is used to select the DAC output range. See page 23 for configuration data. The DACs can be configured for 0-10V or $\pm 10\text{V}$.

Two parameters are configured: unipolar/bipolar mode and power-up/reset clear mode. In most cases, for unipolar mode set the board to reset to zero scale, and for bipolar mode configure the board for reset to mid-scale. In each case the DACs will reset to 0V.

14.4 D/A Conversion Formulas and Tables

The formulas below explain how to convert between D/A codes and output voltages.

D/A Conversion Formulas for Unipolar Output Ranges

$$\text{Output voltage} = (\text{D/A code} / 4096) * \text{Reference voltage}$$

$$\text{D/A code} = (\text{Output voltage} / \text{Reference voltage}) * 4096$$

Example: Output range in unipolar mode = 0 – 10V
Full-scale range = 10V – 0V = 10V
Desired output voltage = 2.000V
D/A code = 2.000V / 10V * 4096 = 819.2 => 819

Note the output code is always an integer.

For the unipolar output range 0-10V, 1 LSB = 1/4096 * 10V = 2.44mV.

Here is an illustration of the relationship between D/A code and output voltage for a unipolar output range (V_{REF} = Reference voltage):

<u>D/A Code</u>	<u>Output voltage symbolic formula</u>	<u>Output voltage for 0 – 10V range</u>
0	0V	0.0000V
1	1 LSB ($V_{REF} / 4096$)	0.0024V
...
2047	$V_{REF} / 2 - 1 \text{ LSB}$	4.9976V
2048	$V_{REF} / 2$	5.0000V
2049	$V_{REF} / 2 + 1 \text{ LSB}$	5.0024V
...
4095	$V_{REF} - 1 \text{ LSB}$	9.9976V

D/A Conversion Formulas for Bipolar Output Ranges

$$\text{Output voltage} = ((\text{D/A code} - 2048) / 2048) * \text{Output reference}$$

$$\text{D/A code} = (\text{Output voltage} / \text{Output reference}) * 2048 + 2048$$

Example: Output range in bipolar mode = $\pm 10\text{V}$
Full-scale range = $10\text{V} - (-10\text{V}) = 20\text{V}$
Desired output voltage = 2.000V
D/A code = $2\text{V} / 10\text{V} * 2048 + 2048 = 2457.6 \Rightarrow 2458$

For the bipolar output range $\pm 10\text{V}$, 1 LSB = $1/4096 * 20\text{V}$, or 4.88mV .

Here is an illustration of the relationship between D/A code and output voltage for a bipolar output range (V_{REF} = Reference voltage):

<u>D/A Code</u>	<u>Output voltage symbolic formula</u>	<u>Output voltage for $\pm 10\text{V}$ range</u>
0	$-V_{\text{REF}}$	-10.0000V
1	$-V_{\text{REF}} + 1 \text{ LSB}$	-9.9951V
...
2047	-1 LSB	-0.0049V
2048	0	0.0000V
2049	$+1 \text{ LSB}$	0.0049V
...
4095	$V_{\text{REF}} - 1 \text{ LSB}$	9.9951V

15. GENERATING AN ANALOG OUTPUT

This chapter describes the steps involved in generating an analog output (also called performing a D/A conversion) on a selected output channel using direct programming (not with the driver software).

There are three steps involved in performing a D/A conversion:

1. **Compute the D/A code for the desired output voltage**
2. **Write the value to the selected output channel**
3. **Wait for the D/A to update**

15.1 Compute the D/A code for the desired output voltage

Use the formulas on the preceding page to compute the D/A code required to generate the desired voltage.

⇒ **Note:** The DAC cannot generate the actual full-scale reference voltage; to do so would require an output code of 4096, which is not possible with a 12-bit number. The maximum output value is 4095. Therefore the maximum possible output voltage is always 1 LSB less than the full-scale reference voltage.

15.2 Write the value to the selected output channel

First use the following formulas to compute the LSB and MSB values:

LSB = D/A Code & 255 ;keep only the low 8 bits

MSB = int(D/A code / 256) ;strip off low 8 bits, keep 4 high bits

Example:

Output code = 1776

LSB = 1776 & 255 = 240 (F0 Hex); MSB = int(1776 / 256) = int(6.9375) = 6

The LSB is an 8-bit number in the range 0-255. The MSB is a 4-bit number in the range 0-15.

The MSB is always rounded DOWN. The truncated portion is accounted for by the LSB.

Now write these values to the selected channel. The LSB is written to Base + 6. The MSB and channel number are written to Base + 7. The 2-bit channel no. (0-3) is written to bits 7 and 6, and the MSB is written to bits 3-0.

```
outp(Base + 6, LSB);
```

```
outp(Base + 7, MSB + channel << 6);
```

15.3 Wait for the D/A to update

Writing the MSB and channel number to Base + 7 starts the D/A update process for the selected channel. The update process requires approximately 30 microseconds to transmit the data serially to the D/A chip and then update the D/A circuit in the chip. During this period, no attempt should be made to write to any other channel in the D/A through addresses Base + 6 or Base + 7.

The status bit DACBUSY (Base + 3 bit 4) indicates whether the D/A is busy updating (1) or idle (0). After writing to the D/A, monitor this bit until it is zero before proceeding to the next D/A operation.

16. ANALOG CIRCUIT CALIBRATION

Calibration applies only to boards with the analog I/O circuit.

The analog I/O circuit is calibrated during production test prior to shipment. Over time the circuit may drift slightly. If calibration is desired follow the procedure below. For analog I/O circuit configuration see page 23.

Four adjustments are possible:

- ◆ A/D bipolar offset
- ◆ A/D unipolar offset
- ◆ A/D full-scale
- ◆ D/A full-scale

No adjustment for D/A offset is possible.

16.1 A/D bipolar offset

Potentiometer **R66**, **BPOF** is used for adjustment. Configure the circuit for Bipolar A/D mode. Input 0V to any input channel and perform A/D conversions on that channel. The gain setting and single-ended vs. differential mode do not matter. Adjust R66 until the A/D value is 0. To eliminate the effects of noise, it is best to take a number of readings and average the values.

16.2 A/D unipolar offset

Potentiometer **R67**, **UNOF** is used for adjustment. Configure the circuit for Unipolar A/D mode. The gain setting and single-ended vs. differential mode do not matter. Input 0V to any input channel and perform A/D conversions on that channel. Adjust R67 until the A/D value is 0~1. To eliminate the effects of noise, it is best to take a number of readings and average the values.

16.3 A/D full-scale

Potentiometer **R74**, **ADFS** is used for adjustment. Configure the circuit for Bipolar A/D mode $\pm 10V$. Input 9.9945V to any input channel and perform A/D conversions on that channel using a gain setting of 1. Single-ended vs. differential mode does not matter. Adjust R74 until the average A/D value is 32750. To eliminate the effects of noise, it is best to take a number of readings and average the values.

Any input voltage and A/D reading near the top of the range (10V) can be used for the calibration target voltage/reading. The above value is provided as an example.

16.4 D/A full scale

Potentiometer **R89**, **DAFS** is used for adjustment. Configure the D/A for 0-10V output range. Write the output code of 4095 to all four D/A channels. Measure each one and adjust R89 until the average reading is as close to 9.9976 as possible.

17. DIGITAL I/O OPERATION

Athena contains 24 digital I/O lines organized as three 8-bit I/O ports, A, B, and C. The direction for each port is programmable, and port C is further divided into two 4-bit halves, each with independent direction. The ports are accessed at registers Base + 8 through Base + 10 respectively, and the direction register is at Base + 11.

Base +	7	6	5	4	3	2	1	0
8	PA7	PA6	PA5	PA4	PA3	PA2	PA1	PA0
9	PB7	PB6	PB5	PB4	PB3	PB2	PB1	PB0
10	PC7	PC6	PC5	PC4	PC3	PC2	PC1	PC0
11	DIOCTR			DIRA	DIRCH		DIRB	DIRCL

The digital I/O lines are located at pins 1 through 24 on the I/O header J14 (see page 15). They are 3.3V and 5V logic compatible. Each output is capable of supplying -8mA in logic 1 state and $+12\text{mA}$ in logic 0 state. See the specifications on page 70 for more detail.

DIRA, DIRB, DIRCH, and DIRCL control the direction of ports A, B, C4-7, and C0-3. A 0 means output and a 1 means input. All ports power up to input mode and the output registers are cleared to zero. When a port direction is changed to output, its output register is cleared to zero. When a port is in output mode, its value can be read back.

DIOCTR is used to control the function of lines C7-C4 on the I/O connector. When DIOCTR=1, the lines are C7-C4. When DIOCTR=0, these lines are counter/timer lines:

Pin No.	DIOCTR = 1	DIOCTR = 0	Pin direction for DIOCTR = 0
21	C4	Gate 0	Input
22	C5	Gate 1	Input
23	C6	Clk 1	Input
24	C7	Out 0	Output

18. COUNTER/TIMER OPERATION

Athena contains two counter/timers that provide various timing functions on the board for A/D timing and user functions. These counters are controlled with registers in the on-board data acquisition controller FPGA. See pages 44 and 49 for information on the counter/timer control register bits and how to perform various functions using these counters.

18.1 Counter 0 – A/D Sample Control

The first counter, Counter 0, is a 24-bit “divide-by-n” counter used for controlling A/D sampling. The counter has a clock input, a gate input, and an output. The input is a 10MHz or 1MHz clock provided on the board and selected with bit CKFRQ0 in Base + 4 bit 5. The gate is an optional signal that can be input on pin 21 of the I/O header J14 when DIOCTR (Base + 11 bit 7) is 1. If this signal is not used then the counter runs freely. The output is a positive pulse whose frequency is equal to the input clock divided by the 24-bit divisor programmed into the counter. The output appears on pin 24 of the I/O header when DIOCTR=1.

The counter operates by counting down from the programmed divisor value. When it reaches zero, it outputs a positive-going pulse equal to one input clock period (100ns or 1 μ s, depending on the input clock selected by CKFRQ0). It then reloads to the initial load value and repeats the process indefinitely.

The output frequency can range from 5MHz (10MHz clock, divisor = 2) down to 0.06Hz (1MHz clock divided by 16,777,215, or $2^{24}-1$). The output is fed into the A/D timing circuit and can be selected to trigger A/D conversions when AINTE is 1 and ADCLK is 0 in Base + 4. Using the control register at Base + 15 the counter can be loaded, cleared, enabled, and disabled, the optional gate can be enabled and disabled, and the counter value can be latched for reading.

18.2 Counter 1 – Counting/Totalizing Functions

The second counter, Counter 1, is similar to Counter 0 except it is a 16-bit counter. It also has an input, a gate, and an output. These signals may be user-provided on the I/O header when DIOCTR=0 or the input may come from the on-board clock generator. When the on-board clock generator is used, the clock frequency is either 10MHz or 100KHz as determined by control bit CKFRQ1 in Base + 4.

The output is a positive-going pulse that appears on pin 26 of the I/O header. The output pulse occurs when the counter reaches zero. When the counter reaches zero it will reload and start over on the next clock pulse. The output stays high the entire time the counter is at zero, i.e. from the input pulse that causes the counter to reach zero until the input pulse that causes the counter to reload.

When DIOCTR=0, Counter 1 operates as follows: It counts positive edges of the signal on pin 23 on the I/O header. The gate is provided on pin 22. If it is high then the counter will count, and if it is low the counter will hold its value and ignore input pulses. This pin has a pull-up so the counter can operate without any external gate signal.

NOTE: When counting external pulses, Counter 1 will only update its read register every 4th pulse. This behavior is due to the synchronous design of the counter having to contend with the asynchronous input pulses. The count register contents are correct on the 4th pulse but will remain static until 4 more pulses occur on the input.

When DIOCTR=1, Counter 1 operates as follows: It takes its input from the on-board clock generator based on the value of the CKFRQ1 bit in Base + 4. There is no gating and the counter runs continuously.

Counter 1 may be used as either a pulse generator or a totalizer/counter. In pulse generator mode the output signal on pin 26 is of interest. In totalizer/counter mode the counter value is of interest and may be read by first latching the value and then reading it. The width of the pulse is equal to the time period of the selected counters clock source.

18.3 Command Sequences

Diamond Systems provides driver software to control the counter/timers on Athena. The information here is intended as a guide for programmers writing their own code in place of the driver and also to give a better understanding of the counter/timer operation.

The counter control register is shown below.

Base + 15 Write Counter/Timer Control Register

Bit No.	7	6	5	4	3	2	1	0
Name	CTRNO	LATCH	GTDIS	GTEN	CTDIS	CTEN	LOAD	CLR

To make a counter run (load and enable a counter)

1. Load the desired initial value into the counter.
2. If you want to use the gate function, enable the gate.
3. Enable the counter.

To read a counter

1. Latch the counter. The counter continues to operate.
2. Read the value from the data registers.

A counter may be enabled or disabled at any time. If disabled, the counter will ignore incoming clock edges.

The gating may be enabled or disabled at any time. When gating is disabled, the counter will count all incoming edges. When gating is enabled, if the gate is high the counter will count all incoming edges, and if the gate is low the counter will ignore incoming clock edges.

Loading and enabling a counter

For counter 0, three bytes are required to load a 24-bit value. For counter 1, two bytes are needed for a 16-bit value. The value is an unsigned integer.

- a. Write the data to the counter:

Break the load value into 3 bytes, low, middle, and high (two bytes for counter 1). Then write the bytes to the data registers in any sequence.

Counter 0

```
outp(base+12,low);
outp(base+13,middle);
outp(base+14,high);
```

Counter 1

```
outp(base+12,low);
outp(base+13,high);
```

- b. Load the counter:

Counter 0

```
outp(base+15,0x02);
```

Counter 1

```
outp(base+15,0x82);
```

- c. Enable the gate if desired:

Counter 0

```
outp(base+15,0x10);
```

Counter 1

```
outp(base+15,0x90);
```

- d. Enable the counter:

Counter 0

```
outp(base+15,0x04);
```

Counter 1

```
outp(base+15,0x84);
```

Reading a counter

- a. Latch the counter:

Counter 0
outp(base+15,0x40);

Counter 1
outp(base+15,0xC0);

- b. Read the data:

The value is returned in 3 bytes, low, middle, and high (2 bytes for counter 1)

Counter 0
low=inp(base+12);
middle=inp(base+13);
high=inp(base+14);

Counter 1
low=inp(base+12);
high=inp(base+13);

- c. Assemble the bytes into the complete counter value:

Counter 0
val = high * 2¹⁶ + middle * 2⁸ + low;

Counter 1
val = high * 2⁸ + low;

Enabling the counter gate

Counter 0
outp(base+15,0x10);

Counter 1
outp(base+15,0x90);

The counter will run only when the gate input is high.

Disabling the counter gate

Counter 0
outp(base+15,0x20);

Counter 1
outp(base+15,0xA0);

The counter will run continuously.

Clearing a counter

Clearing a counter is done when you want to restart an operation. Normally you only clear a counter after you have stopped (disabled) and read the counter. If you clear a counter while it is still enabled, it will continue to count incoming pulses, so its value may not stay at zero.

- a. Stop (disable) the counter:

Counter 0
outp(base+15,0x08);

Counter 1
outp(base+15,0x88);

- b. Read the data (optional). See "Reading a counter" above.

- c. Clear the counter:

Counter 0
outp(base+15,0x01);

Counter 1
outp(base+15,0x81);

19. WATCHDOG TIMER PROGRAMMING

19.1 Watchdog Timer

Athena contains a watchdog timer circuit consisting of one programmable timer, WDT. The input to the circuit is WDI, and the output is WDO. Both signals appear on the watchdog connector J6. WDI may be triggered in hardware or in software. A special “early” version of WDO may be output on the WDO pin. When this signal is connected to WDI, the watchdog circuit will be retriggered automatically.

The duration of the timer is user-programmable. When WDT is triggered, it begins to count down. When it reaches zero, it will generate a user-selectable combination of these events:

- ◆ System Management interrupt (SMI)
- ◆ Hardware reset

The watchdog timer circuit is programmed via I/O registers located at address 0x25C. Detailed programming info can be found below. The Athena watchdog timer is supported in the DSC Universal Driver software version 5.7 and later.

Address	Write Function	Read Function
0x25C	WDT trigger register	None, write only
0x25D	WDT, counter register	None, write only
0x25E	Watchdog control register	Readback, see details
0x25F	Chip select enable/disable	Readbacks the same written bits

Register Map Bit Assignments

A blank bit in the write registers is unused. A blank bit in the read registers reads back as 0 or 1, unknown state.

WRITE

Address	7	6	5	4	3	2	1	0
0x25C				WDTRIG				
0x25D	WDT3	WDT2	WDT1	WDT0				
0x25E	WDIEN	WDOEN	WDSMI	WDEDGE				
0x25F	COM4EN	COM3EN	FPGAEN	WDEN				

READ

Address	7	6	5	4	3	2	1	0
0x25C								
0x25D								
0x25E	WDIEN	WDOEN	WDSMI	WDEDGE				
0x25F	COM4EN	COM3EN	FPGAEN	WDEN				

Table 22: I/O COM3/4 Control Register Definition

19.2 Watchdog Timer Register Details

0x25C Write WDT Trigger Register

Bit No.	7	6	5	4	3	2	1	0
Name				WDTRIG				

WDTRIG Writing a 1 to this bit triggers an immediate software reload of the WDT watchdog timer.

0x25C Read WDT Trigger Register

This register does not read back.

0x25D Write WDT Counter Register

Bit No.	7	6	5	4	3	2	1	0
Name	WDT3	WDT2	WDT1	WDT0				

WDT0-3 Writing to bits WDT0-3 loads WDT with the 4-bit counter value. Use this register to set the WDT countdown period. Each tick takes 145ms, so you can set the period between 145ms (1) and 2.175ms (15).

0x25D Read WDT Counter Register

This register does not read back.

0x25E Write WDT Control Register

Bit No.	7	6	5	4	3	2	1	0
Name	WDIEN	WDOEN	WDSMI	WDEDGE				

- WDIEN 0 = Disable edges on the WDI pin retriggering WDT.
1 = Enable edges on the WDI pin retriggering WDT.
- WDOEN 0 = Disable edge on WDO pin when WDT reaches 1.
1 = Enable edge on WDO pin when WDT reaches 1.
- WDSMI 0 = Disable SMI signal when WDT reaches 0.
1 = Enable SMI signal when WDT reaches 0.
- WDEDGE 0 = Falling edge on WDI retriggers WDT when WDIEN = 1.
1 = Rising edge on WDI retriggers WDT when WDIEN = 1.

0x25E Read WDT Control Register

Reads back current state of the WDT Control Register.

0x25F Write Chip select enable/disable

Bit No.	7	6	5	4	3	2	1	0
Name	COM4EN	COM3EN	FPGAEN	WDEN				

- COM4EN COM4 chip select enable. 1 = enable COM4-CS#. 0 = disable COM4-CS#.
- COM3EN COM3 chip select enable. 1 = enable COM3-CS#. 0 = disable COM3-CS#.
- FPGAEN FPGA chip select enable. 1 = enable FPGA-CS#. 0 = disable FPGA-CS#.
- WDEN Watchdog enable. 1 = WDT counter enable. 0 = WDT counter disable, WDO disable, WDI disable, CPURST# disable, EXTSMI# disable.
- The CPLD initializes all values to zero on power up. The BIOS then enables each resource based on BIOS settings.*

0x25F Read Chip select enable/disable

Bit No.	7	6	5	4	3	2	1	0
Name	COM4EN	COM3EN	FPGAEN	WDEN				

Reads back current state of the chip select values

19.3 Example : Watchdog Timer With Software Trigger

Software trigger relies on a thread of execution to constantly trigger WDT. If the thread is ever halted, WDT will reach zero and initiate the reset sequence.

In this example we will set the watchdog timer to a countdown period of 2.175 seconds. Note that longer timeout periods should typically be used when relying on software-based triggers for the Watchdog Timer in order to accommodate varying software latencies (interrupt latencies, other tasks with priority at certain times, etc)

Setting up the watchdog timer:

```
outp(0x25D, 0xF0);           //set WDT to 15 (2.175 sec)
outp(0x25F, inp(0x25F) | 0x10); //set WDEN chip select high to enable WDT.
```

The timer is now setup and active. A separate thread should be constantly running this code:

```
while (1)
{
  outp(0x25C, 0x10);           //reset WDT
  sleep(1000);               //sleep one second
}
```

If this thread is interrupted or if the parent process crashes, then the board will reset 2 seconds after the last trigger is received.

19.4 Example : Watchdog Timer With Hardware Trigger

Hardware trigger relies on an external pulse to constantly retrigger WDT. If the external stream of pulses is ever halted, WDT will reach zero and initiate the reset sequence.

In this example, we will make use of the “WDOEN” feature to automatically reset WDT unless a physical connection is broken. The physical connection must be made between WDO and WDI on the watchdog header J6.

Since software is not involved in maintaining the timer, we can set the reset period to a much smaller value. In this example, the reset pulse will travel across the physical connection every 435 milliseconds.

```
outp(0x25D, 0x30);           //set WDT to 3 (435 ms)
outp(0x25E, 0xD0);           //set WDIEN=1, WDOEN=1, WDEDGE=1
outp(0x25F, inp(0x25F) | 0x10); //set WDEN chip select
```

Now when WDT reaches 1, a rising edge will flow from WDO to WDI, resetting the timer back to 3 and lowering the signal on WDO. When the connection from WDO to WDI is severed, the rising edge will never reach WDI and the system will reset.

20. DATA ACQUISITION SPECIFICATIONS

These specifications apply to units with Data Acquisition Only

Analog Inputs

No. of inputs	8 differential or 16 single-ended (user selectable)
A/D resolution	16 bits (1/65,536 of full scale)
Input ranges	Bipolar: $\pm 10V$, $\pm 5V$, $\pm 2.5V$, $\pm 1.25V$ Unipolar: 0-8.3V, 0-5V, 0-2.5V
Input bias current	50nA max
Maximum input voltage	$\pm 10V$ for linear operation
Overvoltage protection	$\pm 35V$ on any analog input without damage
Nonlinearity	± 3 LSB, no missing codes
Drift	10PPM/ $^{\circ}C$ typical
Conversion rate	100,000 samples per second max
Conversion trigger	software trigger, internal pacer clock, or external TTL signal
FIFO	48 samples; programmable interrupt threshold

Analog Outputs

No. of outputs	4
D/A resolution	12 bits (1/4096 of full scale)
Output ranges	Unipolar: 0-10V or user-programmable Bipolar: $\pm 10V$ or user-programmable
Output current	± 5 mA max per channel
Settling time	4 μ S max to $\pm 1/2$ LSB
Relative accuracy	± 1 LSB
Nonlinearity	± 1 LSB, monotonic

Digital I/O

No. of lines	24
Compatibility	3.3V and 5V logic compatible
Input voltage	Logic 0: -0.5V min, 0.8V max; Logic 1: 2.0V min, 5.5V max
Input current	± 1 μ A max
Output voltage	Logic 0: 0.0V min, 0.4V max; Logic 1: 2.4V min, 3.3V max
Output current	Logic 0: 12mA max; Logic 1: -8mA max
I/O capacitance	10pF max

Counter/Timers

A/D pacer clock	24-bit down counter
Pacer clock source	10MHz, 1MHz, or external signal
General purpose	16-bit down counter
GP clock source	10MHz, 100KHz, or external signal

21. FLASHDISK MODULE

Athena is designed to accommodate an optional flashdisk module. This module contains 32MB to 128MB of solid state non-volatile memory that operates like an IDE drive without requiring any additional driver software support.

Model	Capacity
FD-32	32MB
FD-64	64MB
FD-96	96MB
FD-128	128MB



21.1 Installing the Flashdisk Module

The flashdisk module installs directly on the IDE connector J16 and is held down with a spacer and two screws onto a mounting hole on the board.

The flashdisk module contains a jumper for master/slave configuration. For master, install the jumper over pins 1&2, and for slave install the jumper over pins 2&3.

21.2 Configuration

To configure the CPU to work with the Flashdisk module, enter the BIOS (press F2 during startup). Select the Main menu, and then select IDE Primary Master. Enter the following settings:

Type:	User
Cylinders:	489 for 32MB flashdisk
Heads:	4 for 32MB flashdisk
Sectors:	32 for 32MB flashdisk
Multi Sector Transfer:	Disable
LBA Mode Control:	Enable
32 Bit I/O:	Disable
Transfer Mode:	Fast PIO 1
Ultra DMA Mode:	Disable

Exit the BIOS and save your change. The system will now boot and recognize the FlashDisk module as drive C:.

21.3 Using the Flashdisk with Another IDE Drive

Since the flashdisk occupies the board's IDE connector, mounting it on the board prevents the simultaneous use of another IDE drive with the same IDE port. To utilize both the flashdisk and another drive, an adapter board, such as Diamond Systems' ACC-IDEEXT, and cables are required. The ACC-IDEEXT adapter board is described on page 72.

21.4 Power Supply

The 44-pin cable carries power from the CPU to the adapter board and will power the flashdisk module and any drive using a 44-pin connector, such as a notebook hard drive.

A drive utilizing a 40-pin connector, such as a CD-ROM or full-size hard drive, requires an external power source through an additional cable. The power may be provided from the CPU's power out connector (J12) or from one of the two 4-pin headers on the ACC-IDEEXT board. Diamond Systems' cable no. **698006** may be used with either power connector to bring power to the drive.

22. FLASH DISK PROGRAMMER BOARD

The Flash Disk Programmer Board accessory model no. **ACC-IDEEXT** may be used for several purposes. Its primary purpose is to enable the simultaneous connection of both a flashdisk module and a standard IDE hard drive or CD-ROM drive to allow file transfers to/from the flashdisk. This operation is normally done at system setup. The board can also be used to enable the simultaneous connection of two drives to the CPU.

J1 connects to the IDE connector on Athena with a 44-pin ribbon cable (Diamond Systems' part no. **698004**). Both 40-pin .1" spacing (J4) and 44-pin 2mm spacing (J3) headers are provided for the external hard drive or CD-ROM drive. A dedicated connector (J2) is provided for the flashdisk module. Any two devices may be connected simultaneously using this board with proper master / slave jumper configurations on the devices.

The Flash Disk Programmer Board comes with a 44-wire cable no. (DSC no. **698004**) and a 40-wire cable no. (DSC no. **C-40-18**) for connection to external drives. The flashdisk module is sold separately.

The 44-pin connector (J1, J2, and J3) and mating cable carry power, but the 40-pin connector (J4) and mating cable do not. J5 and J6 on the accessory board may be used to provide power to a 44-pin device attached to the board when the board is attached to a PC via a 40-pin cable. These headers are compatible with the floppy drive power connector on a standard PC internal power cable.

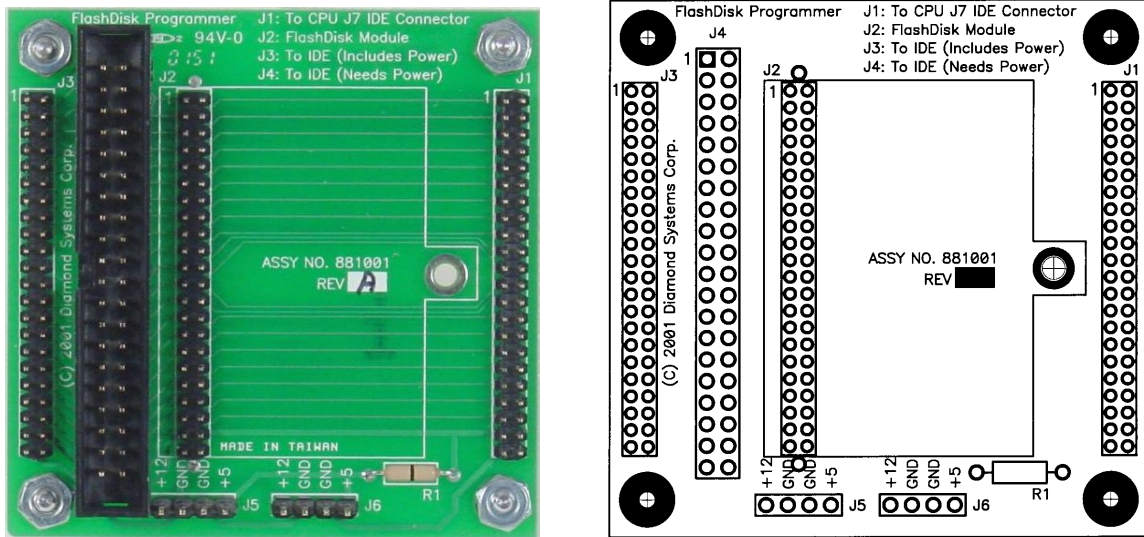

Figure 1 : ACC-IDEEXT FlashDisk Programmer Board

23. I/O CABLES

Diamond Systems offers a cable kit no. **C-ATH-KIT** with 10 cables to connect to all I/O headers on the board. Some cables are also available separately.

The mating cable for each I/O connector is listed in Chapter 4.

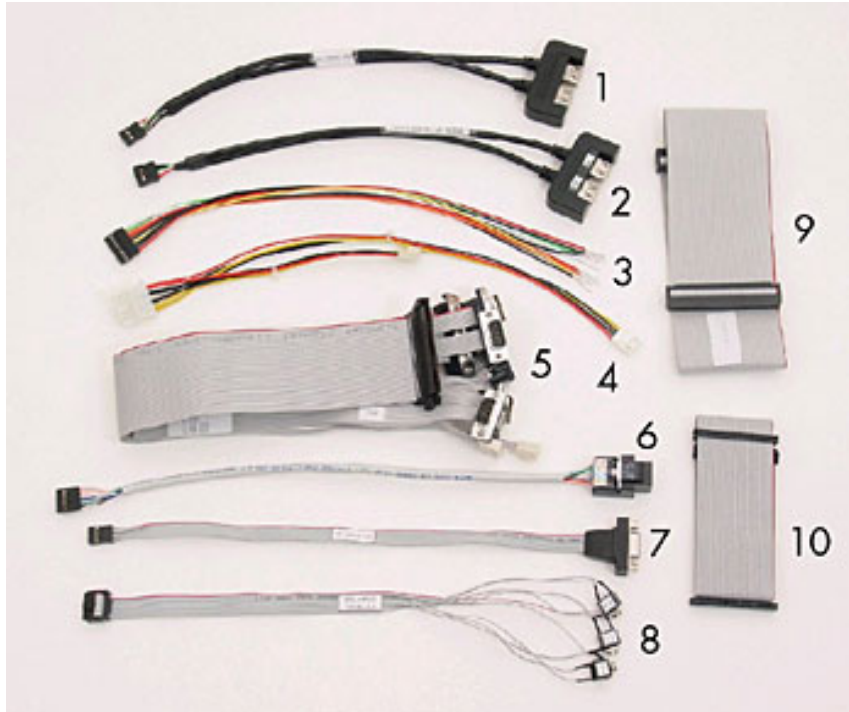

Figure 2 : Cable Kit C-ATH-KIT

Photo No.	Cable No.	Description
1	698032	USB cable, ports 2 & 3
2	698012	USB cable, ports 0 & 1
3	698009	Power input cable
4	698006	Power output cable
5	C-PRZ-01	80-wire / 2-cable breakout cable assembly with serial, parallel, PS/2 mouse/keyboard, power, reset, speaker, & LED connectors
6	C-PRZ-02	Ethernet cable
7	698030	VGA cable
8	698031	Audio cable
9	C-50-18	Data acquisition, 50 conductor .1" ribbon cable
10	698004	IDE, 44 conductor 2mm ribbon cable

Table 23: Cable Kit C-ATH-KIT Contents

24. QUICK START GUIDE

This section will describe the steps necessary to get your Athena up and running. It is assumed that you have also purchased the Athena Development Kit. This kit includes all cables described on page 73, a power supply, USB floppy drive, mounting hardware, IDE flashdisk and the flashdisk programmer board. More details about the development kit can be found here:

<http://www.diamondsystems.com/products/athena#dk>

24.1 General Setup

This section describes the initial setup that will be identical no matter which operating system or IDE configuration you choose to use.

- 1) Remove the Athena board from its packaging.
- 2) Install the mounting kit standoffs into the PC/104 mounting holes located at each corner of the board. This ensures that the board will not touch the surface beneath it, and will help redistribute the force when you push connectors onto the board.
- 3) Attach the high density ribbon cable C-PRZ-01 to locking connector J3. Make sure the cable is inserted snugly and the connector has locked. If you have a PS/2 mouse and keyboard, attach them to the corresponding connectors on C-PRZ-01.
- 4) Attach the VGA cable 698030 to J25. Connect your monitor's VGA cable to the DB9 socket.
- 5) Take the power supply out of its packaging. Do not plug it into the wall yet. Plug the 9-pin connector into J11 of the Athena board, right below the PC/104 bus. Take care that the red wire (+5 VDC) goes to pin 1.
- 6) *Optional for Ethernet:* Plug cable C-PRZ-02 into J4. You can use the RJ-45 socket on the C-PRZ-02 cable to patch Athena into your network.
- 7) *Optional for USB Devices:* You will need to connect the USB cables if you are going to use a USB floppy, keyboard or mouse. Plug USB cable 698012 into J5. If you need 3 or 4 USB sockets, connect cable 698032 into J21.

24.2 IDE Configuration

Athena has a single IDE channel that can support up to two devices simultaneously (Master and Slave.) IDE devices connect through J8, which is a 44-pin, laptop IDE pinout. Here are a few example setups:

- 1) One IDE flashdisk connected directly to J8.
- 2) One laptop IDE harddrive connected directly to J8 through a 44-pin ribbon cable. This cable comes in the cable kit (cable 698004.)
- 3) Use cable 698004 to connect an IDE flashdisk programmer board to J8. You can then connect other 40-pin or 44-pin IDE compatible devices to the programmer board. Use cable 698006 attached to J12 to provide power from the Athena board to 40-pin devices. Remember that the Athena cannot generate 12VDC itself. You will have to supply your own 12VDC line to the IDE device, or through the Athena power input connector.

24.3 Booting into MS-DOS, FreeDOS or ROM-DOS

This section describes how to boot into a DOS-based operating system via a bootable floppy disk.

- 1) Plug the USB floppy drive into one of the USB terminals of cable 698012 (see step 7.)
- 2) Insert your DOS-based boot disk into the USB floppy drive.
- 3) Connect the power supply to the wall (to provide power to Athena)
- 4) At this point the Athena will boot and you should see the BIOS power-on self test (POST.) Press F2 at this screen to enter BIOS configuration.
- 5) Under the "Advanced" menu, scroll to "Legacy USB Support" and enable it. Without enabling this option, the BIOS will not boot from a disk in the USB floppy drive.
- 6) Reboot the system. It will now boot of your floppy.

24.4 Booting into Linux or Microsoft Windows

This section describes how to setup the Athena board in preparation for a Linux or Windows install from an installation CD-ROM onto a laptop IDE harddrive.

- 1) Connect the IDE flashdisk programmer board to J8 (see section 24.2.)
- 2) Connect a CD-ROM drive jumpered for the slave position to the IDE flashdisk programmer board through the 40-pin cable.
- 3) Connect power to the CD-ROM drive using cable 698006 attached to J12. Be sure that an external 12VDC source is being supplied to J11.
- 4) Connect a laptop harddrive jumpered for master position to the second slot of the 44-pin cable.
- 5) Boot the Athena by plugging the power supply into the wall.
- 6) Go to the BIOS configuration screen by pressing F2 at the power-on self test.
- 7) Go to the "Boot" menu and ensure that the CD-ROM drive is first boot device.
- 8) Insert the boot CD for your operating system into the CD-ROM drive.
- 9) Save BIOS settings and reboot.
- 10) You should now be able to install your OS.