

XTX-945

Intel® Core™ 2 Duo (Merom)/
Core™ Duo/ Core™ Solo/
Celeron® M (Yonah) Processor
With LCD, Ethernet, PCI-E,
Audio, SATA, SDVO

Copyright Notice

This document is copyrighted, 2008. All rights are reserved. The original manufacturer reserves the right to make improvements to the products described in this manual at any time without notice.

No part of this manual may be reproduced, copied, translated, or transmitted in any form or by any means without the prior written permission of the original manufacturer. Information provided in this manual is intended to be accurate and reliable. However, the original manufacturer assumes no responsibility for its use, or for any infringements upon the rights of third parties that may result from its use.

The material in this document is for product information only and is subject to change without notice. While reasonable efforts have been made in the preparation of this document to assure its accuracy, AAEON assumes no liabilities resulting from errors or omissions in this document, or from the use of the information contained herein.

AAEON reserves the right to make changes in the product design without notice to its users.

Acknowledgments

All other products' name or trademarks are properties of their respective owners.

- Award is a trademark of Award Software International, Inc.
- Intel[®], Core[™] 2 Duo, Core[™] Duo, Core[™] Solo and Celeron[®] M are trademarks of Intel[®] Corporation.
- Microsoft Windows[®] is a registered trademark of Microsoft Corp.
- ITE is a trademark of Integrated Technology Express, Inc.
- IBM, PC/AT, PS/2, and VGA are trademarks of International Business Machines Corporation.

Please be notified that all other products' name or trademarks not be mentioned above are properties of their respective owners.

Packing List

Before you begin installing your card, please make sure that the following materials have been shipped:

- 1 XTX-945 CPU Module
- 1 CD-ROM for manual (in PDF format) and drivers

If any of these items should be missing or damaged, please contact your distributor or sales representative immediately.

Application Notes

1. IRQ resource issue for SATA card:

If you want to use the SATA card, you have to use the CN39 (PCI-Express [x1] slot) instead of the CN40 (PCI-Express [x1] slot) of ECB-910M due to the IRQ resource limitation.

2. Display issue for 640x480 LVDS LCD panel:

If you use 640x480 LVDS LCD panel and Intel Graphics Utility to set the display mode, ex. Clone Mode or Extended Desktop Mode, the display may change to 4-bit color (16-color level) when you switch the display mode setting.

You can use the path below to recover the resolution to 640x480:

[Control Panel\ Display Properties\ Setting\ Advanced\ Adapter\ List All Modes](#)

For more details, please contact with AAEON Customer Service Department for help.

Contents

Chapter 1 General Information

1.1 Introduction.....	1-2
1.2 Features	1-3
1.3 Specifications	1-4

Chapter 2 Quick Installation Guide

2.1 Safety Precautions	2-2
2.2 Mechanical Drawing	2-3
2.3 List of Jumpers	2-5
2.4 List of Connectors	2-6
2.5 Setting Jumpers	2-7
2.6 BIOS Write Protect (JP1) (Reserved)	2-8
2.7 SDVO Port Connector (CN2)	2-8
2.8 XTX Connector (XTX1)	2-8
2.9 XTX Connector (XTX2)	2-10
2.10 XTX Connector (XTX3)	2-12
2.11 XTX Connector (XTX4)	2-14

Chapter 3 Award BIOS Setup

3.1 System Test and Initialization.	3-2
3.2 Award BIOS Setup	3-3

Chapter 4 Driver Installation

4.1 Installation	4-3
------------------------	-----

Appendix A Programming The Watchdog Timer

A.1 ProgrammingA-2
 A.2 IT8712 Watchdog Timer Initial Program.....A-6

Appendix B I/O Information

B.1 I/O Address MapB-2
 B.2 1st MB Memory Address MapB-3
 B.3 IRQ Mapping Chart.....B-4
 B.4 DMA Channel Assignments.....B-4

Chapter

1

**General
Information**

1.1 Introduction

XTX-945 is able to equip with Intel® Core™ 2 Duo (Merom)/ Core™ Duo/ Core™ Solo/ Celeron® M (Yonah) processors and has one 200-pin DDR II 400/533/667 SODIMM to support system memory up to 2GB. XTX-945 adopts Intel® 945GME+ ICH7-M chipset that implements serial technologies with high performance. In addition, XTX-945 accommodates user-friendly expansion interfaces, ex: four PCI-Express [x1] , four 32-bit PCI, one LPC bus, one SMBus and one I2C interface.

For the display specifications, XTX-945 integrates Intel® 945GME and shared system memory is up to 224MB. The display of XTX-945 supports CRT and 24-bit dual-channel LVDS LCD. Moreover, it supports NTSC/ PAL/ HDTV and Composite Video, S-Video on the carrier board. In addition, one SDVO port can be used through the SDVO connector to provide more flexibility for display function.

Compared to the ETX modules, the ISA bus has been replaced by SATA and PCI-Express interfaces on XTX modules. If you are looking for an economic, time-saving and high performance solution, XTX-945 definitely is your first choice.

1.2 Features

- Intel® Core™ 2 Duo (Merom)/ Core™ Duo/ Core™ Solo/ Celeron® M (Yonah) Processors
- DDR II 400/533/667 Memory
- CRT/ Up to 24-bit Dual-channel LVDS LCD/ TV
- 10/100Mbps Ethernet
- AC97 Audio Codec
- PCI-Express [x1] x 4
- SATA x 2
- SDVO Connector x 1
- +5V Operating Voltage
- XTX Form Factor

1.3 Specifications

System

- CPU Intel® (Socket 478-based) Core™ 2 Duo (Merom)/ Core™ Duo/ Core™ Solo/ Celeron® M (Yonah) Processors
- Memory One 200-pin DDR II SODIMM, supports DDR 400/533/667 up to 2GB
- Chipset Intel® 945GME+ICH7-M
- Ethernet Intel EP82562ET, 10/100Base-TX
- BIOS Award, TSOP type, 1MB ROM
- Watchdog Timer Generates a Time-out System Reset
- H/W Status Monitoring Supports Power Supply Voltages, Fan Speed and Temperatures Monitoring
- Wake on LAN Yes
- Expansion Interface PCI-E [x1] x4
32-bit PCI x 4
LPC Bus x 1
SMBus x 1
I2C x 1
- Power Supply Voltage +5V DC
- Board Size 4.5”(L) x 3.74”(W) (114mm x 95mm)
- Gross Weight 0.66lb (0.3kg)
- Operating Temperature 32°F~140°F (0°C~60°C)
- Storage Temperature -40°F~176°F (-40°C~80°C)

Display: Supports CRT/LCD, CRT/TV, LCD/TV Dual simultaneous/ Dual independent display

- Chipset Intel® 945GME integrated
- Memory Shared system memory up to 224MB
- Resolution Up to 2048x1536 (QXGA) for CRT; Up to 1600x1200 (UXGA) for LCD
- LCD Interface 18-bit dual-channel LVDS from Intel® 945GME directly (TF-XTX-945-A10); Up to 24-bit dual-channel LVDS from Chrontel CH7308B (TF-XTX-945-A10-01)
- SDVO Port One SDVO port can be used through the SDVO connector
- TV-Out Intel 945GME integrated, supports NTSC/PAL/HDTV; HDTV supports: 480p/ 720p/ 1080i/ 1080p; supports Composite Video, S-Video on carrier board

I/O

- Storage PATA x 1, SATA x 2
- Serial Port 2
- Parallel Port 1
- USB USB2.0 x 6
- PS/2 Port Keyboard x 1, Mouse x 1
- IrDA One IrDA Tx/Rx header

- **Audio** Mic-in, Line-in, Line-out (XTX1 connector), High definition audio (XTX2 connector)

Chapter

2

**Quick
Installation
Guide**



2.1 Safety Precautions

Warning!

Always completely disconnect the power cord from your board whenever you are working on it. Do not make connections while the power is on, because a sudden rush of power can damage sensitive electronic components.

Caution!

Always ground yourself to remove any static charge before touching the board. Modern electronic devices are very sensitive to static electric charges. Use a grounding wrist strap at all times. Place all electronic components on a static-dissipative surface or in a static-shielded bag when they are not in the chassis

2.2 Mechanical Drawing

Component Side

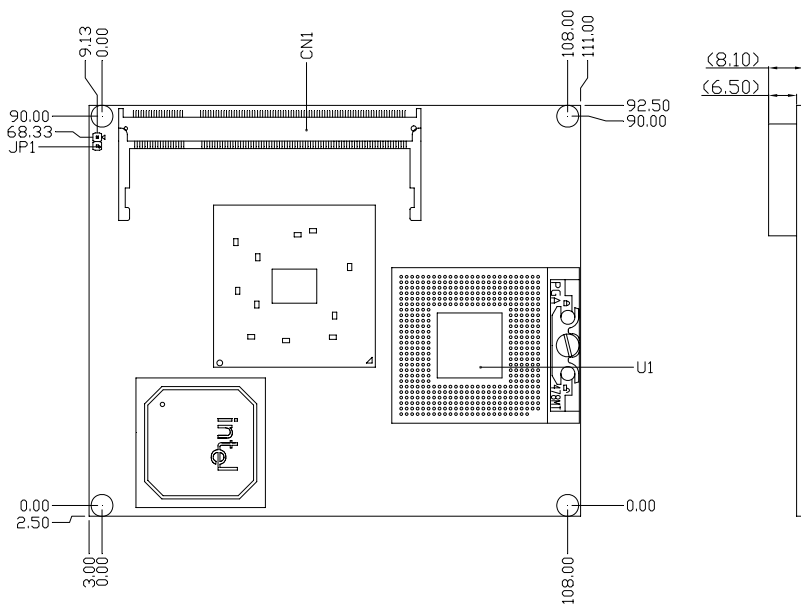

Solder Side

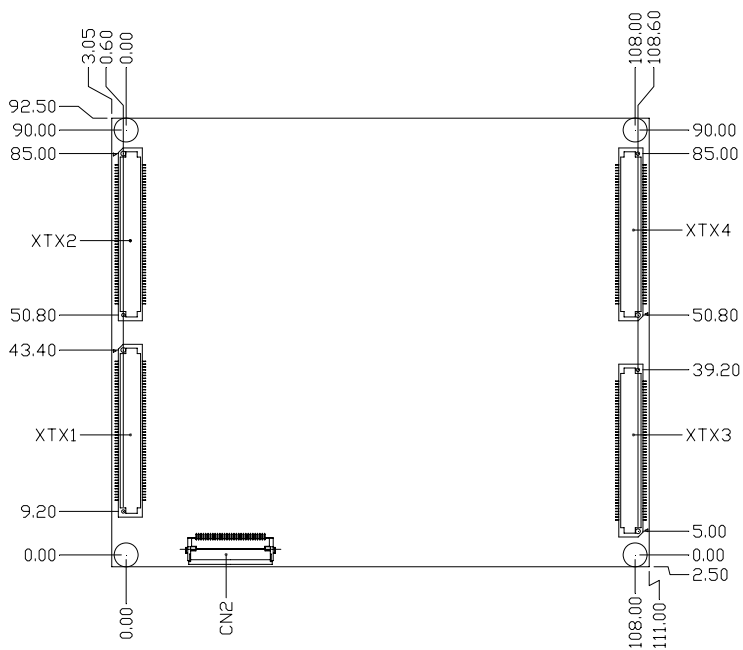

2.3 List of Jumpers

The board has a number of jumpers that allow you to configure your system to suit your application.

The table below shows the function of the board's jumpers:

Jumpers

Label	Function
JP1	BIOS write protect (Reserved)

2.4 List of Connectors

The board has a number of connectors that allow you to configure your system to suit your application.

The table below shows the function of the board's connectors:

Connectors

Label	Function
U1	CPU socket
CN1	DDR2 SODIMM slot
CN2	SDVO connector
XTX1	XTX connector (PCI Bus/4xUSB 2.0/Audio)
XTX2	XTX connector (4xPCI-E/2xUSB 2.0/2xSATA/HDA/LPC/Fan)
XTX3	XTX connector (VGA/LVDS/TV-out/COM1&2/PS-2 KB&MS/IR/Parallel Port)
XTX4	XTX connector (IDE/Ethernet/SMBus/I2C)

2.5 Setting Jumpers

You configure your card to match the needs of your application by setting jumpers. A jumper is the simplest kind of electric switch. It consists of two metal pins and a small metal clip (often protected by a plastic cover) that slides over the pins to connect them. To “close” a jumper you connect the pins with the clip.

To “open” a jumper you remove the clip. Sometimes a jumper will have three pins, labeled 1, 2 and 3. In this case you would connect either pins 1 and 2 or 2 and 3.

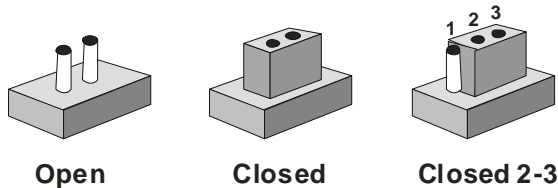

A pair of needle-nose pliers may be helpful when working with jumpers.

If you have any doubts about the best hardware configuration for your application, contact your local distributor or sales representative before you make any change.

Generally, you simply need a standard cable to make most connections.

2.6 BIOS Write Protect (JP1) (Reserved)

JP1	Function
Open	On: BIOS write protect enable Off: BIOS write protect disable

2.7 SDVO Connector (CN2)

Pin	Signal	Pin	Signal
1	GND	2	SDVOC_CLKN
3	SDVOC_CLKP	4	GND
5	SDVOC_GREEN#	6	SDVOC_GREEN
7	GND	8	SDVOC_INT#
9	SDVOC_INT	10	GND
11	SDVOC_BLUE#	12	SDVOC_BLUE
13	GND	14	SDVOC_RED#
15	SDVOC_RED	16	GND
17	SDVO_FLDSTALL#	18	SDVO_FLDSTALL
19	GND	20	SDVO_CTRLCLK
21	SDVO_CTRLDATA	22	SDVOC_RST#
23	VCC3	24	VCC2.5
25	+5V	26	GND
27	N/A	28	N/A
29	N/A	30	N/A

2.8 XTX Connector (XTX1)

Pin	Signal	Pin	Signal
A1	GND	A2	GND
A3	PCICLK3	A4	PCICLK4
A5	GND	A6	GND

A7	PCICLK1	A8	PCICLK2
A9	PCI_REQ#3	A10	PCI_GNT#3
A11	PCI_GNT#2	A12	VCC3
A13	PCI_REQ#2	A14	PCI_GNT#1
A15	PCI_REQ#1	A16	VCC3
A17	PCI_GNT#0	A18	N/A
A19	+5V	A20	+5V
A21	INT_SERIRQ	A22	PCI_REQ#0
A23	PCI_AD0	A24	VCC3
A25	PCI_AD1	A26	PCI_AD2
A27	PCI_AD4	A28	PCI_AD3
A29	PCI_AD6	A30	PCI_AD5
A31	PCI_C/BE#0	A32	PCI_AD7
A33	PCI_AD8	A34	PCI_AD9
A35	GND	A36	GND
A37	PCI_AD10	A38	LIN_L
A39	PCI_AD11	A40	MIC_IN
A41	PCI_AD12	A42	LIN_R
A43	PCI_AD13	A44	VCCAUD
A45	PCI_AD14	A46	LOUT_L
A47	PCI_AD15	A48	GNDAUD
A49	PCI_C/BE#1	A50	LOUT_R
A51	+5V	A52	+5V
A53	PCI_PAR	A54	PCI_SERR#
A55	PCI_PERR#	A56	N/A
A57	PCI_PME#	A58	USB_PN2
A59	PCI_LOCK#	A60	PCI_DEVSEL#
A61	PCI_TRDY#	A62	USB_PN3

A63	PCI_IRDY#	A64	PCI_STOP#
A65	PCI_FRAME#	A66	USB_PP2
A67	GND	A68	GND
A69	PCI_AD16	A70	PCI_C/BE#2
A71	PCI_AD17	A72	USB_PP3
A73	PCI_AD19	A74	PCI_AD18
A75	PCI_AD20	A76	USB_PN0
A77	PCI_AD22	A78	PCI_AD21
A79	PCI_AD23	A80	USB_PN1
A81	PCI_AD24	A82	PCI_C/BE#3
A83	+5V	A84	+5V
A85	PCI_AD25	A86	PCI_AD26
A87	PCI_AD28	A88	USB_PP0
A89	PCI_AD27	A90	PCI_AD29
A91	PCI_AD30	A92	USB_PP1
A93	PCI_RST#	A94	PCI_AD31
A95	INT_PIRQC#	A96	INT_PIRQD#
A97	INT_PIRQA#	A98	INT_PIRQB#
A99	GND	A100	GND

2.9 XTX Connector (XTX2)

Pin	Signal	Pin	Signal
B1	GND	B2	GND
B3	PCIESLOT1_CLK	B4	SATA_RXP0
B5	PCIESLOT1_CLK#	B6	SATA_RXN0
B7	GND	B8	GND
B9	PCIE_TXP3	B10	SATA_TXN0
B11	PCIE_TXN3	B12	SATA_TXP0

B13	GND	B14	5VDUAL
B15	PCIE_RXP3	B16	SATA_RXP1
B17	PCIE_RXN3	B18	SATA_RXN1
B19	+5V	B20	5VDUAL
B21	N/A	B22	SATA_TXN1
B23	PCIE2_RST#	B24	SATA_TXP1
B25	USB_PP5	B26	GND
B27	USB_PN5	B28	N/A
B29	GND	B30	N/A
B31	PCIE_TXP2	B32	PM_SUS_STAT#
B33	PCIE_TXN2	B34	PM_CLKRUN#
B35	GND	B36	GND
B37	PCIE_RXP2	B38	N/A
B39	PCIE_RXN2	B40	N/A
B41	N/A	B42	GND
B43	PCIE1_RST#	B44	N/A
B45	USB_PP4	B46	N/A
B47	USB_PN4	B48	WDT_RST
B49	PM_SLP_S3#	B50	SATALED
B51	+5V	B52	+5V
B53	PCIE_RXN1	B54	N/A
B55	PCIE_RXP1	B56	N/A
B57	GND	B58	N/A
B59	PCIE_TXN1	B60	Reserved(5VDUAL)
B61	PCIE_TXP1	B62	PM_THRM#
B63	PCIE_WAKE#	B64	N/A
B65	PM_SLP_S5#	B66	N/A
B67	GND	B68	GND

B69	PCIE_RXN0	B70	N/A
B71	PCIE_RXP0	B72	N/A
B73	GND	B74	+5V
B75	PCIE_TXN0	B76	FAN_TAC2
B77	PCIE_TXP0	B78	FAN_CTL2
B79	N/A	B80	+5V
B81	ACZ_RST0#	B82	ACZ_SDATAOUT0
B83	+5V	B84	+5V
B85	ACZ_SYNC0	B86	ACZ_SDATAIN0
B87	ACZ_SDATAIN1	B88	ACZ_SDATAIN2
B89	ACZ_BITCLK0	B90	FAN_TAC
B91	LPC_AD0	B92	Smart_Fan
B93	LPC_AD1	B94	LPC_FRAME#
B95	LPC_AD2	B96	ICH_DRQ#0
B97	LPC_AD3	B98	ICH_DRQ#1
B99	GND	B100	GND

2.10 XTX Connector (XTX3)

Pin	Signal	Pin	Signal
C1	GND	C2	GND
C3	CRT_RED	C4	CRT_BLUE
C5	CRT_HSYNC	C6	CRT_GREEN
C7	CRT_VSYNC	C8	CRT_DDC_CLK
C9	N/A	C10	CRT_DDC_DATA
C11	LVDS_TXUCLK#	C12	LVDS_TXU3#
C13	LVDS_TXUCLK	C14	LVDS_TXU3
C15	GND	C16	GND
C17	LVDS_TXU1	C18	LVDS_TXU2

C19	LVDS_TXU1#	C20	LVDS_TXU2#
C21	GND	C22	GND
C23	LVDS_TXL3#	C24	LVDS_TXU0
C25	LVDS_TXL3	C26	LVDS_TXU0#
C27	GND	C28	GND
C29	LVDS_TXL2#	C30	LVDS_TXLCLK
C31	LVDS_TXL2	C32	LVDS_TXLCLK#
C33	GND	C34	GND
C35	LVDS_TXL0	C36	LVDS_TXL1
C37	LVDS_TXL0#	C38	LVDS_TXL1#
C39	+5V	C40	+5V
C41	LVDS_DDCPDATA	C42	LTGIO
C43	LVDS_DDCPCLK	C44	LVDS_BKLEN
C45	L_BKLTCTL	C46	LVDS_DIGON
C47	TV_DACA_OUT	C48	TV_DACB_OUT
C49	N/A	C50	TV_DACC_OUT
C51	N/A	C52	GP11
C53	+5V	C54	GND
C55	STB#	C56	AFD#
C57	N/A	C58	PD7
C59	IRRX	C60	ERR#
C61	IRTX	C62	PD6
C63	RXB#	C64	PINIT#
C65	GND	C66	GND
C67	RTSB#	C68	PD5
C69	DTRB#	C70	SLIN#
C71	DCDB#	C72	PD4
C73	DSRB#	C74	PD3

C75	CTSB#	C76	PD2
C77	TXB#	C78	PD1
C79	RIB#	C80	PD0
C81	+5V	C82	+5V
C83	RXA#	C84	ACK#
C85	RTSA#	C86	BUSY
C87	DTRA#	C88	PE
C89	DCDA#	C90	SLCT
C91	DSRA#	C92	MSCLK#
C93	CTSA#	C94	MSDAT#
C95	TXA#	C96	KBCLK#
C97	RIA#	C98	KBDAT#
C99	GND	C100	GND

2.11 XTX Connector (XTX4)

Pin	Signal	Pin	Signal
D1	GND	D2	GND
D3	5VDUAL	D4	HWRST#
D5	PS_ON	D6	ACZ_SPKR
D7	ATXBTN#	D8	RTCBAT
D9	N/A	D10	LINK_LED#
D11	N/A	D12	ACT_LED#
D13	N/A	D14	10_100_LED#
D15	ETX_PRG	D16	SMBCLK
D17	+5V	D18	+5V
D19	OC#	D20	GPIO0#
D21	EXTSMI#	D22	SMBDATA
D23	SMBCLK	D24	SMBDATA

D25	N/A	D26	SMB_LINK_ALERT#
D27	N/A	D28	+5V
D29	N/A	D30	IDE_PDCS3#
D31	N/A	D32	IDE_PDCS1#
D33	GND	D34	GND
D35	N/A	D36	IDE_PDA2
D37	N/A	D38	IDE_PDA0
D39	N/A	D40	IDE_PDA1
D41	PM_BATLOW#	D42	N/A
D43	N/A	D44	INT_IRQ14
D45	N/A	D46	IDE_PDDACK#
D47	N/A	D48	IDE_PDIPRDY
D49	+5V	D50	+5V
D51	N/A	D52	IDE_PDIOR#
D53	N/A	D54	IDE_PDIOW#
D55	N/A	D56	IDE_PDDREQ
D57	N/A	D58	IDE_PDD15
D59	N/A	D60	IDE_PDD0
D61	N/A	D62	IDE_PDD14
D63	N/A	D64	IDE_PDD1
D65	GND	D66	GND
D67	N/A	D68	IDE_PDD13
D69	N/A	D70	IDE_PDD2
D71	N/A	D72	IDE_PDD12
D73	N/A	D74	IDE_PDD3
D75	N/A	D76	IDE_PDD11
D77	N/A	D78	IDE_PDD4
D79	N/A	D80	IDE_PDD10

D81	+5V	D82	+5V
D83	N/A	D84	IDE_PDD5
D85	N/A	D86	IDE_PDD9
D87	N/A	D88	IDE_PDD6
D89	ICH_RI#	D90	P66DET
D91	RDN	D92	IDE_PDD8
D93	RDP	D94	N/A
D95	TDN	D96	IDE_PDD7
D97	TDP	D98	IDERST#
D99	GND	D100	GND

Below Table for China RoHS Requirements

产品中有毒有害物质或元素名称及含量

AAEON Main Board/ Daughter Board/ Backplane

部件名称	有毒有害物质或元素					
	铅 (Pb)	汞 (Hg)	镉 (Cd)	六价铬 (Cr(VI))	多溴联苯 (PBB)	多溴二苯醚 (PBDE)
印刷电路板 及其电子组件	×	○	○	○	○	○
外部信号 连接器及线材	×	○	○	○	○	○
<p>O: 表示该有毒有害物质在该部件所有均质材料中的含量均在 SJ/T 11363-2006 标准规定的限量要求以下。</p> <p>X: 表示该有毒有害物质至少在该部件的某一均质材料中的含量超出 SJ/T 11363-2006 标准规定的限量要求。</p> <p>备注: 此产品所标示之环保使用期限, 系指在一般正常使用状况下。</p>						

Chapter

3

**Award
BIOS Setup**

3.1 System Test and Initialization

These routines test and initialize board hardware. If the routines encounter an error during the tests, you will either hear a few short beeps or see an error message on the screen. There are two kinds of errors: fatal and non-fatal. The system can usually continue the boot up sequence with non-fatal errors. Non-fatal error messages usually appear on the screen along with the following instructions:

Press <F1> to RESUME

Write down the message and press the F1 key to continue the boot up sequence.

System configuration verification

These routines check the current system configuration against the values stored in the CMOS memory. If they do not match, the program outputs an error message. You will then need to run the BIOS setup program to set the configuration information in memory.

There are three situations in which you will need to change the CMOS settings:

1. You are starting your system for the first time
2. You have changed the hardware attached to your system
3. The CMOS memory has lost power and the configuration information has been erased.

The XTX-945 memory has an integral lithium battery backup for data retention. However, you will need to replace the complete unit when it finally runs down.

3.2 Award BIOS Setup

Awards BIOS ROM has a built-in Setup program that allows users to modify the basic system configuration. This type of information is stored in battery-backed CMOS RAM so that it retains the Setup information when the power is turned off.

Entering setup

Power on the computer and press immediately. This will allow you to enter Setup.

Standard CMOS Features

Use this menu for basic system configuration. (Date, time, IDE, etc.)

Advanced BIOS Features

Use this menu to set the advanced features available on your system.

Advanced Chipset Features

Use this menu to change the values in the chipset registers and optimize your system performance.

Integrated Peripherals

Use this menu to specify your settings for integrated peripherals. (Primary slave, secondary slave, keyboard, mouse etc.)

Power Management Setup

Use this menu to specify your settings for power management. (HDD power down, power on by ring etc.)

PnP/PCI Configurations

This entry appears if your system supports PnP/PCI.

PC Health Status

This menu shows you the status of PC.

Frequency/Voltage Control

This menu shows you the display of frequency/Voltage Control.

Load Fail-Safe Defaults

Use this menu to load the BIOS default values for the minimal/stable performance for your system to operate.

Load Optimized Defaults

Use this menu to load the BIOS default values that are factory settings for optimal performance system operations. While AWARD has designated the custom BIOS to maximize performance, the factory has the right to change these defaults to meet their needs.

Set Supervisor/User Password

Use this menu to set Supervisor/User Passwords.

Save and Exit Setup

Save CMOS value changes to CMOS and exit setup.

Exit Without Saving

Abandon all CMOS value changes and exit setup.

For more detailed information, you can refer to the "AAEON BIOS Item Description.pdf" file in the CD for the meaning of each setting in this chapter.

Chapter

4

**Driver
Installation**

The XTX-945 comes with a CD-ROM that contains all drivers and utilities that meet your needs.

Follow the sequence below to install the drivers:

- Step 1 – Install INF Driver
- Step 2 – Install VGA Driver
- Step 3 – Install LAN Driver
- Step 4 – Install Audio Driver
- Step 5 – Install Touchpanel Driver
- Step 6 – Install TPM Driver

USB 2.0 Drivers are available for download using Windows Update for both Windows XP and Windows 2000. For additional information regarding USB 2.0 support in Windows XP and Windows 2000, please visit www.microsoft.com/hwdev/usb/.

Please read instructions below for further detailed installations.

4.1 Installation:

Insert the XTX-945 CD-ROM into the CD-ROM Drive. And install the drivers from Step 1 to Step 6 in order.

Step 1 – Install INF Driver

1. Click on the **Step 1 - INF** folder and then double click on the **Setup.exe**
2. Follow the instructions that the window shows
3. The system will help you install the driver automatically

Step 2 – Install VGA Driver

1. Click on the **Step 2 - VGA** folder and select the folder of OS your system is
2. Double click on the **.exe** file
3. Follow the instructions that the window shows
4. The system will help you install the driver automatically

Step 3 – Install LAN Driver

1. Click on the **Step 3 - LAN** folder and double click on the **PRO2KXP.exe**
2. Follow the instructions that the window shows
3. The system will help you install the driver automatically

Step 4 – Install Audio Driver

1. Click on the **Step 4 - AC97** folder and select the folder of OS your system is
2. Double click on the **.exe** file

3. Follow the instructions that the window shows
4. The system will help you install the driver automatically

Step 5 – Install LAN Driver

1. Click on the **Step 5 – Touchpanel** folder and double click on the **Setup.exe**
2. Follow the instructions that the window shows
3. The system will help you install the driver automatically

Step 6 – Install TPM Driver

1. Click on the **Step 6 – TPM DRIVER** folder and double click on the **Setup.exe**
2. Follow the instructions that the window shows
3. The system will help you install the driver automatically

Appendix

A

Programming the Watchdog Timer

A.1 Programming

XTX-945 utilizes ITE 8712 chipset as its watchdog timer controller.

Below are the procedures to complete its configuration and the AAEON initial watchdog timer program is also attached based on which you can develop customized program to fit your application.

Configuring Sequence Description

After the hardware reset or power-on reset, the ITE 8712 enters the normal mode with all logical devices disabled except KBC. The initial state (enable bit) of this logical device (KBC) is determined by the state of pin 121 (DTR1#) at the falling edge of the system reset during power-on reset.

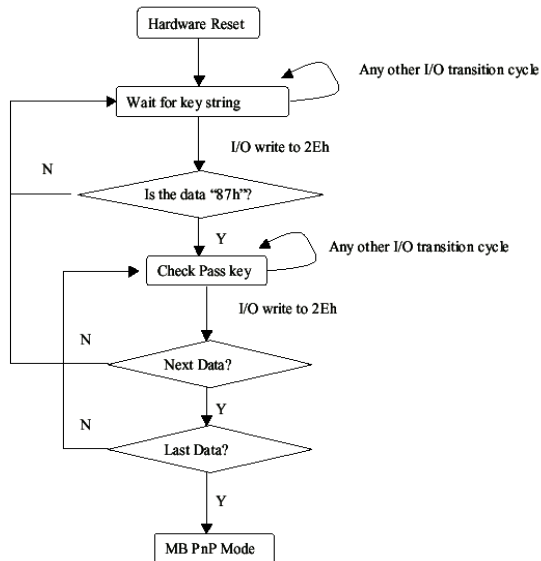

There are three steps to complete the configuration setup: (1) Enter the MB PnP Mode; (2) Modify the data of configuration registers; (3) Exit the MB PnP Mode. Undesired result may occur if the MB PnP Mode is not exited normally.

(1) Enter the MB PnP Mode

To enter the MB PnP Mode, four special I/O write operations are to be performed during Wait for Key state. To ensure the initial state of the key-check logic, it is necessary to perform four write operations to the Special Address port (2EH). Two different enter keys are provided to select configuration ports (2Eh/2Fh) of the next step.

	Address Port	Data Port
87h, 01h, 55h, 55h:	2Eh	2Fh

(2) Modify the Data of the Registers

All configuration registers can be accessed after entering the MB PnP Mode. Before accessing a selected register, the content of Index 07h must be changed to the LDN to which the register belongs, except some Global registers.

(3) Exit the MB PnP Mode

Set bit 1 of the configure control register (Index=02h) to 1 to exit the MB PnP Mode.

WatchDog Timer Configuration Registers

LDN Index R/W Reset Configuration Register or Action				
All	02H	W	N/A	Configure Control
07H	71H	R/W	00H	WatchDog Timer Control Register
07H	72H	R/W	00H	WatchDog Timer Configuration Register
07H	73H	R/W	00H	WatchDog Timer Time-out Value Register

Configure Control (Index=02h)

This register is write only. Its values are not sticky; that is to say, a hardware reset will automatically clear the bits, and does not require the software to clear them.

Bit	Description
7-2	Reserved
1	Returns to the Wait for Key state. This bit is used when the configuration sequence is completed
0	Resets all logical devices and restores configuration registers to their power-on states.

WatchDog Timer Control Register (Index=71h, Default=00h)

Bit	Description
7	WDT is reset upon a CIR interrupt
6	WDT is reset upon a KBC (mouse) interrupt
5	WDT is reset upon a KBC (keyboard) interrupt
4	WDT is reset upon a read or a write to the Game Port base address
3-2	Reserved
1	Force Time-out. This bit is self-clearing
0	WDT Status
	1: WDT value reaches 0.
	0: WDT value is not 0

WatchDog Timer Configuration Register (Index=72h,**Default=00h)**

Bit	Description
7	WDT Time-out value select
	1: Second
	0: Minute
6	WDT output through KRST (pulse) enable
5-4	Reserved
3-0	Select the interrupt level ^{Note} for WDT

WatchDog Timer Time-out Value Register (Index=73h,**Default=00h)**

Bit	Description
7-0	WDT Time-out value 7-0

A.2 IT8712 Watchdog Timer Initial Program

```
.MODEL SMALL
```

```
.CODE
```

Main:

```
CALL Enter_Configuration_mode
```

```
CALL Check_Chip
```

```
mov cl, 7
```

```
call Set_Logic_Device
```

```
;time setting
```

```
mov cl, 10 ; 10 Sec
```

```
dec al
```

Watch_Dog_Setting:

```
;Timer setting
```

```
mov al, cl
```

```
mov cl, 73h
```

```
call Superio_Set_Reg
```

```
;Clear by keyboard or mouse interrupt
```

```
mov al, 0f0h
```

```
mov cl, 71h
```

```
call Superio_Set_Reg
```

```
;unit is second.
```

```
mov al, 0C0H
```

```
mov cl, 72h
```

```
call Superio_Set_Reg
```

```
; game port enable  
mov cl, 9  
call Set_Logic_Device
```

```
Initial_OK:  
CALL Exit_Configuration_mode  
MOV AH,4Ch  
INT 21h
```

```
Enter_Configuration_Mode PROC NEAR  
MOV SI,WORD PTR CS:[Offset Cfg_Port]
```

```
MOV DX,02Eh  
MOV CX,04h  
Init_1:  
MOV AL,BYTE PTR CS:[SI]  
OUT DX,AL  
INC SI  
LOOP Init_1  
RET  
Enter_Configuration_Mode ENDP
```

```
Exit_Configuration_Mode PROC NEAR  
MOV AX,0202h  
CALL Write_Configuration_Data
```

RET

Exit_Configuration_Mode ENDP

Check_Chip PROC NEAR

MOV AL,20h

CALL Read_Configuration_Data

CMP AL,87h

JNE Not_Initial

MOV AL,21h

CALL Read_Configuration_Data

CMP AL,12h

JNE Not_Initial

Need_Initial:

STC

RET

Not_Initial:

CLC

RET

Check_Chip ENDP

Read_Configuration_Data PROC NEAR

MOV DX,WORD PTR CS:[Cfg_Port+04h]

OUT DX,AL

```
MOV DX,WORD PTR CS:[Cfg_Port+06h]
IN AL,DX
RET
Read_Configuration_Data ENDP
```

```
Write_Configuration_Data PROC NEAR
MOV DX,WORD PTR CS:[Cfg_Port+04h]
OUT DX,AL
XCHG AL,AH
MOV DX,WORD PTR CS:[Cfg_Port+06h]
OUT DX,AL
RET
Write_Configuration_Data ENDP
```

```
Superio_Set_Reg proc near
push ax
MOV DX,WORD PTR CS:[Cfg_Port+04h]
mov al,cl
out dx,al
pop ax
inc dx
out dx,al
ret
Superio_Set_Reg endp.Set_Logic_Device proc near
Set_Logic_Device proc near
```

```
push ax
push cx
xchg al,cl
mov cl,07h
call Superio_Set_Reg
pop cx
pop ax
ret
Set_Logic_Device endp
```

```
;Select 02Eh->Index Port, 02Fh->Data Port
Cfg_Port DB 087h,001h,055h,055h
```

```
DW 02Eh,02Fh
```

END Main

Note: Interrupt level mapping

0Fh-Dh: not valid

0Ch: IRQ12

.

.

03h: IRQ3

02h: not valid

01h: IRQ1

00h: no interrupt selected

Appendix

B

































I/O Information

B.1 I/O Address Map

Input/output (IO)	
[00000000 - 0000000F]	Direct memory access controller
[00000000 - 000000CF7]	PCI bus
[00000010 - 0000001F]	Motherboard resources
[00000020 - 00000021]	Programmable interrupt controller
[00000022 - 0000003F]	Motherboard resources
[00000040 - 00000043]	System timer
[00000044 - 0000005F]	Motherboard resources
[00000060 - 00000060]	Standard 101/102-Key or Microsoft Natural PS/2 Keyboard
[00000061 - 00000061]	System speaker
[00000062 - 00000063]	Motherboard resources
[00000064 - 00000064]	Standard 101/102-Key or Microsoft Natural PS/2 Keyboard
[00000065 - 0000006F]	Motherboard resources
[00000070 - 00000073]	System CMOS/real time clock
[00000074 - 0000007F]	Motherboard resources
[00000080 - 00000090]	Direct memory access controller
[00000091 - 00000093]	Motherboard resources
[00000094 - 0000009F]	Direct memory access controller
[000000A0 - 000000A1]	Programmable interrupt controller
[000000A2 - 000000BF]	Motherboard resources
[000000C0 - 000000DF]	Direct memory access controller
[000000E0 - 000000EF]	Motherboard resources
[000000F0 - 000000FF]	Numeric data processor
[000001F0 - 000001F7]	Primary IDE Channel
[00000274 - 00000277]	ISA/PNP Read Data Port
[00000279 - 00000279]	ISA/PNP Read Data Port
[00000290 - 0000029F]	Motherboard resources
[000002E8 - 000002EF]	Communications Port (COM4)
[000002F8 - 000002FF]	Communications Port (COM2)
[00000378 - 0000037F]	Printer Port (LPT1)
[000003B0 - 000003BF]	Mobile Intel(R) 945 Express Chipset Family
[000003C0 - 000003DF]	Mobile Intel(R) 945 Express Chipset Family
[000003E8 - 000003EF]	Communications Port (COM3)
[000003F0 - 000003F5]	Standard floppy disk controller
[000003F6 - 000003F6]	Primary IDE Channel
[000003F7 - 000003F7]	Standard floppy disk controller
[000003F8 - 000003FF]	Communications Port (COM1)
[00000400 - 000004BF]	Motherboard resources
[000004D0 - 000004D1]	Motherboard resources
[00000500 - 0000051F]	Intel(R) 82801G (ICH7 Family) SMBus Controller - 27DA
[00000880 - 0000088F]	Motherboard resources
[00000A79 - 00000A79]	ISA/PNP Read Data Port
[00000D00 - 0000FFFF]	PCI bus
[0000DF00 - 0000DF3F]	Intel(R) PRO/100 VE Network Connection
[0000F000 - 0000F0FF]	Realtek AC'97 Audio
[0000F300 - 0000F30F]	Intel(R) 82801GBM/GHM (ICH7-M Family) Serial ATA Storage Controller - 27C4
[0000F400 - 0000F403]	Intel(R) 82801GBM/GHM (ICH7-M Family) Serial ATA Storage Controller - 27C4
[0000F500 - 0000F507]	Intel(R) 82801GBM/GHM (ICH7-M Family) Serial ATA Storage Controller - 27C4
[0000F600 - 0000F603]	Intel(R) 82801GBM/GHM (ICH7-M Family) Serial ATA Storage Controller - 27C4
[0000F700 - 0000F707]	Intel(R) 82801GBM/GHM (ICH7-M Family) Serial ATA Storage Controller - 27C4
[0000F800 - 0000F80F]	Intel(R) 82801G (ICH7 Family) Ultra ATA Storage Controllers - 27DF
[0000FA00 - 0000FA3F]	Realtek AC'97 Audio
[0000FB00 - 0000FB1F]	Intel(R) 82801G (ICH7 Family) USB Universal Host Controller - 27CB
[0000FC00 - 0000FC1F]	Intel(R) 82801G (ICH7 Family) USB Universal Host Controller - 27CA
[0000FD00 - 0000FD1F]	Intel(R) 82801G (ICH7 Family) USB Universal Host Controller - 27C9
[0000FE00 - 0000FE1F]	Intel(R) 82801G (ICH7 Family) USB Universal Host Controller - 27C8
[0000FF00 - 0000FF07]	Mobile Intel(R) 945 Express Chipset Family

Interrupt request (IRQ)
 Memory

B.2 1st MB Memory Address Map

+ 	Direct memory access (DMA)
+ 	Input/output (IO)
+ 	Interrupt request (IRQ)
- 	Memory
	[00000000 - 0009FFFF] System board
	[000A0000 - 000BFFFF] Mobile Intel(R) 945 Express Chipset Family
	[000A0000 - 000BFFFF] PCI bus
	[000C0000 - 000DFFFF] PCI bus
	[000E0000 - 000EFFFF] System board
	[000F0000 - 000FFFFF] System board
	[00100000 - 3F6DFFFF] System board
	[3F6E0000 - 3F6FFFFF] System board
	[3F750000 - FEBFFFFF] PCI bus
	[D0000000 - DFFFFFFF] Mobile Intel(R) 945 Express Chipset Family
	[E0000000 - EFFFFFFF] Motherboard resources
	[FDCFF000 - FDCFFFFF] Intel(R) PRO/100 VE Network Connection
	[FDE80000 - FDEFFFFFFF] Mobile Intel(R) 945 Express Chipset Family
	[FDF00000 - FDF7FFFF] Mobile Intel(R) 945 Express Chipset Family
	[FDF80000 - FDFBFFFF] Mobile Intel(R) 945 Express Chipset Family
	[FDFFC000 - FDFFC3FF] Intel(R) 82801GBM/GHM (ICH7-M Family) Serial ATA Storage Controller - 27C4
	[FDFFD000 - FDFFD0FF] Realtek AC'97 Audio
	[FDFFE000 - FDFFE1FF] Realtek AC'97 Audio
	[FDFFF000 - FDFFF3FF] Intel(R) 82801G (ICH7 Family) USB2 Enhanced Host Controller - 27CC
	[FEC00000 - FEC00FFF] System board
	[FED13000 - FED1DFFF] System board
	[FED20000 - FED3FFFF] System board
	[FED40000 - FED44FFF] PCI bus
	[FED45000 - FED8FFFF] System board
	[FEE00000 - FEE00FFF] System board
	[FFB00000 - FFB7FFFF] System board
	[FFB80000 - FFBFFFFF] Intel(R) 82802 Firmware Hub Device
	[FFF00000 - FFFFFFFF] System board

B.3 IRQ Mapping Chart



B.4 DMA Channel Assignments

