

ONYX-6910

Fanless Medical Mini PC

Intel® Pentium® M /

Celeron® M Processor

With 1 / 2 PCI slots, PCMCIA,
4 COMs, Audio, CompactFlash™

Copyright Notice

This document is copyrighted, 2006. All rights are reserved. The original manufacturer reserves the right to make improvements to the products described in this manual at any time without notice.

No part of this manual may be reproduced, copied, translated, or transmitted in any form or by any means without the prior written permission of the original manufacturer. Information provided in this manual is intended to be accurate and reliable. However, the original manufacturer assumes no responsibility for its use, or for any infringements upon the rights of third parties that may result from its use.

The material in this document is for product information only and is subject to change without notice. While reasonable efforts have been made in the preparation of this document to assure its accuracy, AAEON assumes no liabilities resulting from errors or omissions in this document, or from the use of the information contained herein.

AAEON reserves the right to make changes in the product design without notice to its users.

Acknowledgments

All other products' name or trademarks are properties of their respective owners.

- Award is a trademark of Award Software International, Inc.
- CompactFlash™ is a trademark of the Compact Flash Association.
- Intel®, Pentium® 4, and Celeron® D are trademarks of Intel® Corporation.
- Microsoft Windows® is a registered trademark of Microsoft Corp.
- PC/AT, PS/2, and VGA are trademarks of International Business Machines Corporation.

All other product names or trademarks are properties of their respective owners.

Packing List

Before you begin operating your PC, please make sure that the following materials are enclosed:

- 1 ONYX-6910 Medical Mini PC
- 1 Phoenix Power Connector
- 2 Wallmount Brackets
- 1 Audio Cable
- 1 Screw Package
- 1 CD-ROM for manual (in PDF format) and drivers

Check and make sure they are included and in good condition and it is better for you to keep the carton and the packing materials in case you might need them for packing or moving in the future. If any of these items are missing or damaged, please contact your distributor or sales representative immediately.

AAEON Branches:

- AAEON Electronics Inc.
3 Crown Plaza, Hazlet, NJ07730, U.S.A
TEL: +1-732-203-9300
FAX: +1-732-203-9311
- AAEON SYSTEMS INC. (East)
3 Crown Plaza, Hazlet, NJ07730, U.S.A
TEL: +1-732-203-9800
FAX: +1-732-203-9886
- AAEON SYSTEMS INC. (West)
445 Capricorn Street, Brea, CA 92821, U.S.A
TEL: +1-714-671-1800
FAX: +1-714-671-1802

Maintenance: to properly maintain and clean the surfaces, use only approved products or clean with a dry applicator

Safety & Warranty

1. Read these safety instructions carefully.
2. Keep this user's manual for later reference.
3. Disconnect this equipment from any AC outlet before cleaning. Do not use liquid or spray detergents for cleaning. Use a damp cloth.
4. For pluggable equipment, the power outlet must be installed near the equipment and must be easily accessible.
5. Keep this equipment away from humidity.
6. Put this equipment on a reliable surface during installation. Dropping it or letting it fall could cause damage.
7. The openings on the enclosure are for air convection. Protect the equipment from overheating. **DO NOT COVER THE OPENINGS.**
8. Make sure the voltage of the power source is correct before connecting the equipment to the power outlet.
9. Position the power cord so that people cannot step on it. Do not place anything over the power cord.
10. All cautions and warnings on the equipment should be noted.
11. If the equipment is not used for a long time, disconnect it from the power source to avoid damage by transient over-voltage.
12. Never pour any liquid into an opening. This could cause fire or electrical shock.
13. Never open the equipment. For safety reasons, only qualified service personnel should open the equipment.

14. If any of the following situations arises, get the equipment checked by service personnel:
- The power cord or plug is damaged.
 - Liquid has penetrated into the equipment.
 - The equipment has been exposed to moisture.
 - The equipment does not work well, or you cannot get it to work according to the users manual.
 - The equipment has been dropped and damaged.
 - The equipment has obvious signs of breakage.
15. DO NOT LEAVE THIS EQUIPMENT IN AN ENVIRONMENT WHERE THE STORAGE TEMPERATURE IS BELOW -20°C (-4°F) OR ABOVE 60°C (140°F). IT MAY DAMAGE THE EQUIPMENT.
16. Use a 3V @ 210 mA lithium battery (Model No. CR2032)

FCC Safety

Warning!



This device complies with Part 15 FCC Rules. Operation is subject to the following two conditions: (1) this device may not cause harmful interference, and (2) this device must accept any interference received including interference that may cause undesired operation.

Caution:

It may cause danger of explosion if battery is incorrectly replaced. Replace only with the same or equivalent type recommended by the manufacturer. Dispose of used batteries according to the manufacturer's instructions.

Contents

Chapter 1 General Information

1.1 Introduction.....	1-2
1.2 Features	1-4
1.3 Specifications	1-5
1.4 I/O.....	1-8

Chapter 2 Quick Installation Guide

2.1 Dimension	2-2
2.2 Hard Disk Drive Module Installation	2-4
2.3 PCI Card Installation	2-9
2.4 Wallmount Kit Installation.....	2-13

Chapter 3 Award BIOS Setup

3.1 System Test and Initialization.	3-2
3.2 Award BIOS Setup	3-3

Chapter 4 Driver Installation

4.1 Installation	4-3
------------------------	-----

Appendix A Programming The Watchdog Timer

A.1 Programming	A-2
A.2 ITE8712 Watchdog Timer Initial Program	A-6

Appendix B I/O Information

B.1 I/O Address Map	B-2
---------------------------	-----

B.2 Memory Address MapB-3
B.3 IRQ Mapping ChartB-4
B.4 DMA Channel AssignmentsB-4

Chapter

1

**General
Information**

1.1 Introduction

More and more industrial PC companies are developing the vertical market, namely, the Medical market. As a professional and experienced embedded computing and system integrating company, AAEON provides a full range of medical devices to echo the increasing demands of the Medical market. In order to complete the product line of medical stations and displays, AAEON announces the latest fanless medical Mini PC--The ONYX-6910.

In the Medical market, medical devices are required to be compliant with medical regulations, such as UL60601-1, EN 60601-1. ONYX-6910 has complied with these certifications for power leakage and electronic emission approvals. It transcends consumer PCs or industrial PCs in the market and offers a quality guarantee with high performance. Customers not only demand a quality and performance driven PC, but also a noiseless one in the medical environment. ONYX-6910 features fanless, zero noise and a long lifecycle and is a robust Mini PC for the vertical marketplace.

ONYX-6910 adopts Intel Pentium M up to 2.0GHz/ Celeron M processors. It features DDR SDRAM DIMM up to 1GB, and optional nVIDIA FX-5200 up to 128MB for 3D graphic support. For integrating medical devices, ONYX-6910 deploys rich I/O

interfaces for expansion, such as one PCI slot (2nd PCI available), two PCMCIA slots, four COM ports, four USB2.0 ports, Audio port, Parallel ports, CompactFlash slot and an optional high speed IEEE-1394 interface, etc. These expansion interfaces enable ONYX-6910 to connect with various devices that make medical treatments easier and more convenient for medical practitioners.

1.2 Features

- Fanless, Zero Noise and Long Life Guaranteed
- Medical Grade FCC, CE, UL, EN Approval
- Intel® Pentium® M (up to 2.0GHz)/ Celeron® M Processors
- 1 PCI/ 2 PCMCIA Slots
- Ethernet/ 4 COM/ 4 USB/ Audio/ Paralle/ CFD
- High Speed IEEE-1394 Interface Optional
- 3D Graphic Support for Image/ Media

1.3 Specifications

System

- CPU: Intel® Pentium® M/ Celeron® M Processors
- System Memory: DDR RAM SODIMM x 1, Max. 1GB
- Expansion: PCI slot x 1 (Optional 2nd PCI); PCMCIA x 2
- VGA: DB-15 VGA connector
- Keyboard/Mouse: PS/2 Keyboard & Mouse
- Ethernet: 10/100Base-TX RJ-45 Connector x 1
- SSD: CompactFlash™ slot x 1
- Device Bay: Internal 2.5" HDD Bay
- Serial Port: RS-232 x 4
- Audio: Line-in / Line-out / MIC-in
- Parallel Port: Parallel Port x 1
- USB: USB 2.0 port x 4
- Watchdog Timer: Generates a time-out system reset, setting via software
- Power Supply: 1. DC Input -- Internal DC-DC Converter (Default)
Input voltage: 9V DC~30VDC
2. AC Input -- External Power

- Adapter (Optional)
Input voltage: 100V AC ~ 240V
AC @ 50 ~ 60Hz
- System Control: Power on / off switch x 1
Reset button x 1
- Indicators: Power LED x 1;
HDD active LED x 1

Mechanical and Environmental

- Construction: Rugged Aluminum Alloy
Chassis
- Color: Medical White
- Mounting: Wallmount, Desktop
- Dimension: 1 PCI-214mm(W) x 94.75mm(H) x
237.8mm(D);
2 PCI-214mm (W) x 117.5mm(H)x
237.8mm (D)
- Net Weight: 1 PCI-12.41lb (5.63kg)
2 PCI-13.69lb (6.21kg)
- Gross Weight: 21.21lb (9.62kg)
- Operating Temperature: 5°F ~ 131°F (-15°C ~ 55°C)
(P-M 1.6GHz,CFD);
5°F ~122°F (-15°C ~ 50°C)
(P-M 1.6GHz, Automotive
HDD);

5°F ~ 113°F (-15°C ~ 45°C)

(P-M 1.6GHz, Normal HDD)

- Operating Humidity: 5~95%@40°C, non-condensing
- Vibration: 3 g rms / 5~500Hz / random operation (CFD);
1 g / 5~500Hz / random operation (HDD)
- Shock: 50g peak acceleration (11 msec. duration);
20g peak acceleration (11 msec. duration) (HDD)
- EMC: CE/FCC class B
- UL: UL60601-1

1.4 I/O

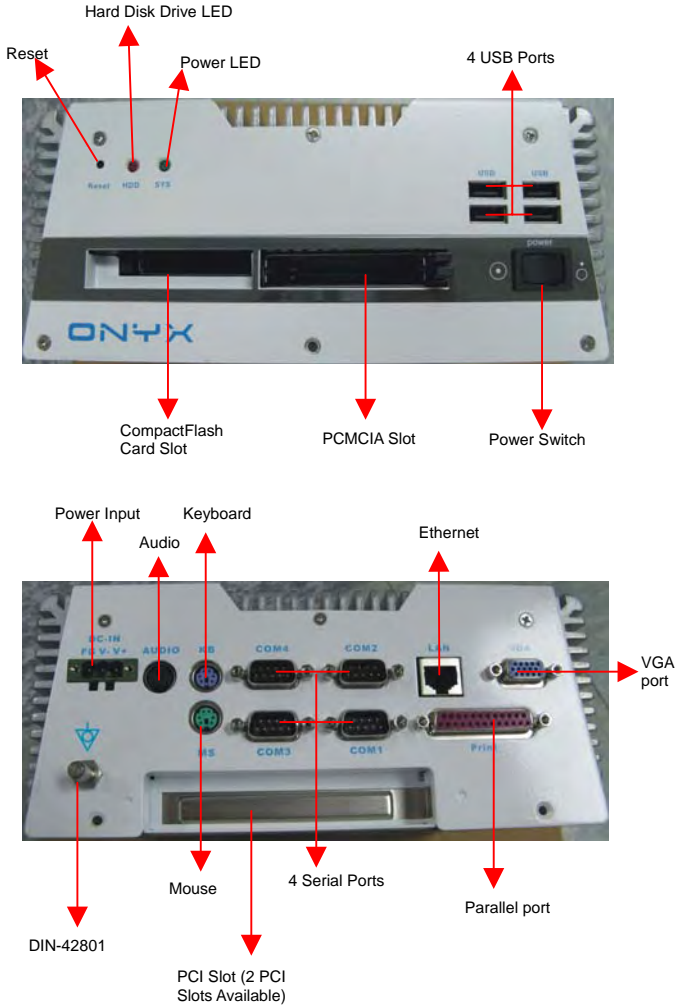

Chapter

2

**Hardware
Installation**

2.1 Dimension

1 PCI Slot Version

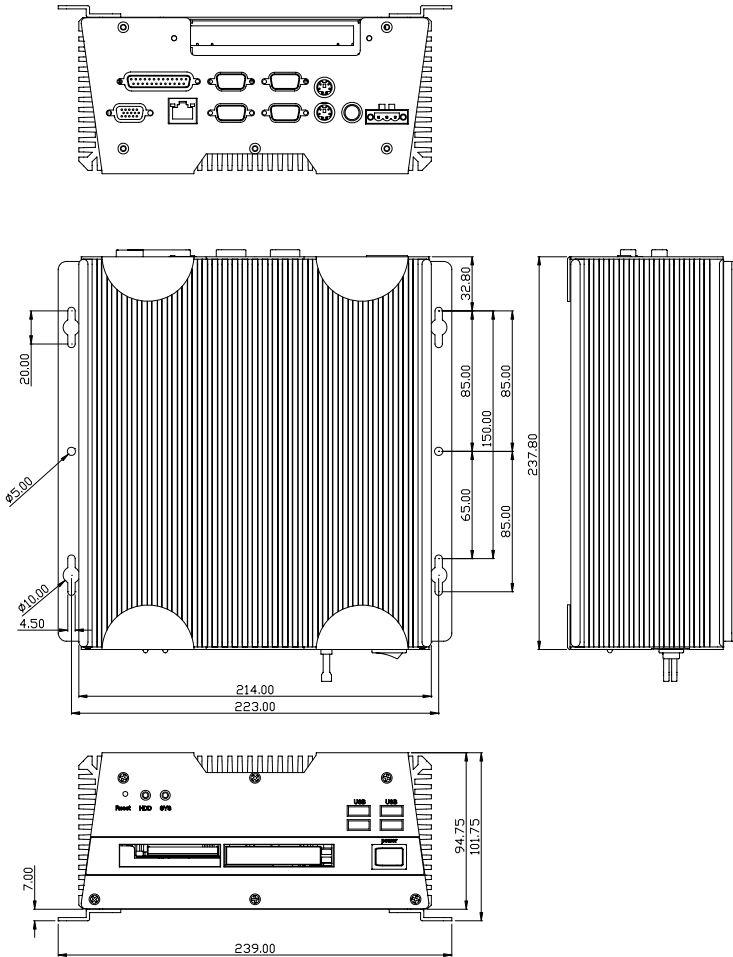

2 PCI Slots Version

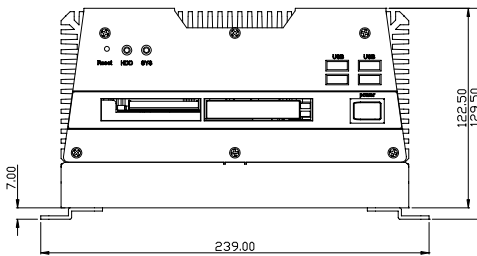
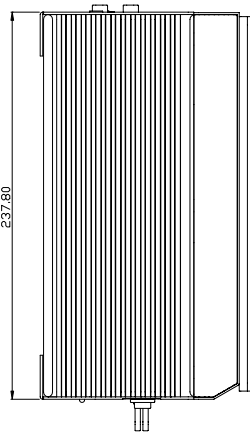
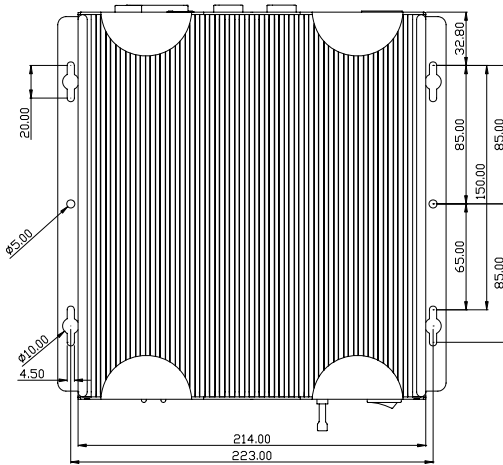
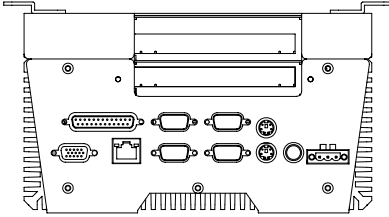

2.2 Hard Disk Drive Module Installation

2.2.1 Disassemble the ONYX-6910

For Hard Disk Drive (HDD) installation, you have to disassemble the bottom lid of ONYX-6910 and some components and covers in the ONYX-6910.

Step 1: Unfasten the two screws on the rear panel.



Step 2: Unfasten the screws in blue circle on the front panel.



Step 3: Unfasten the six screws on the bottom lid.

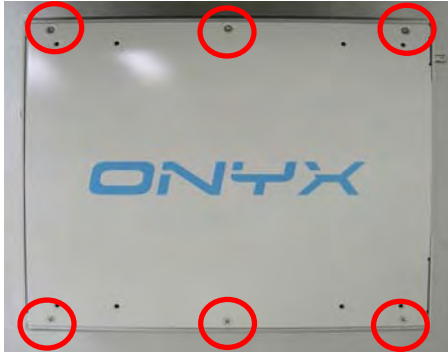

Step 4: Take off the bottom lid and loosen the two screws on the riser card and remove the riser card.

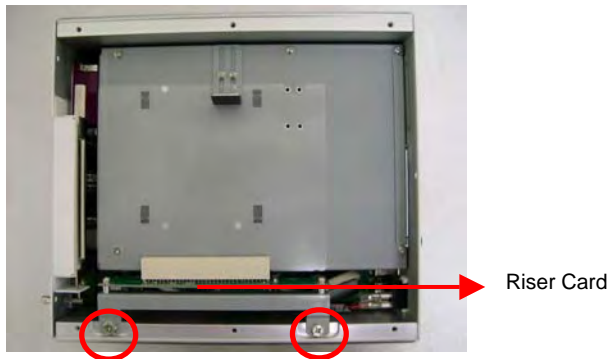

Step 5: Unfasten the five screws and open the HDD cover.

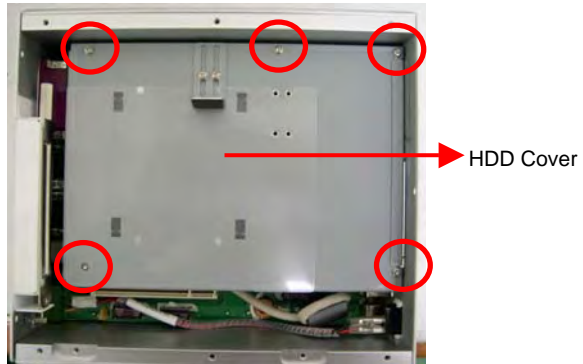

Step 6: Loosen the four screws on the HDD bracket.

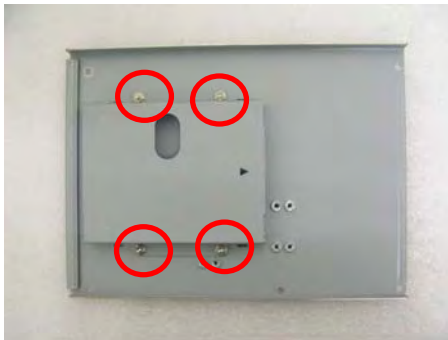

2.2.2 Assemble the HDD Module

After disassembling the ONYX-6910, you have to get the HDD module ready for the proceeding installation.

Step 1: Get four pink rubber bumpers from the accessory kit and wrap them around the four screws on the HDD Module.

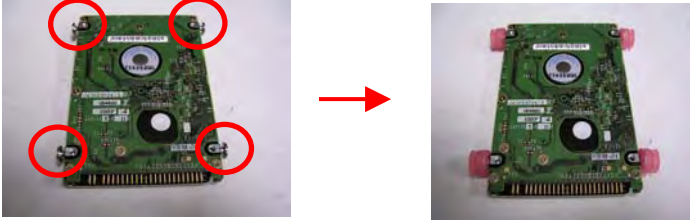

Step 2: Place the bumpers at the four indentations of the two sides of the HDD bracket



Step 3: Connect the power cable to the HDD module.



Step 4: Get the HDD cover ready and combine the HDD Bracket with the HDD cover; fasten the four screws in the blue circles shown below.

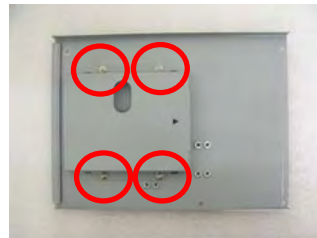

Step 5: Close the HDD cover and fasten the five screws on the HDD cover. Close the bottom lid of the ONYX-6910 and fasten six screws on the bottom lid; the HDD installation is now finished.

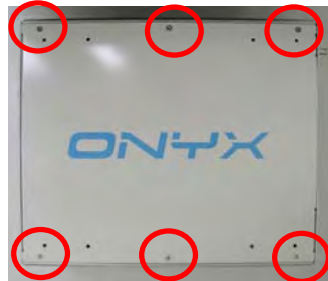
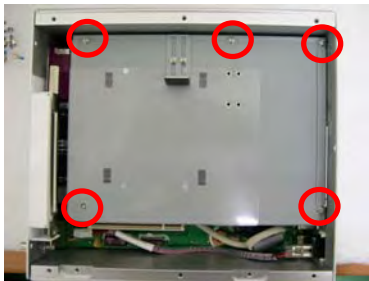

2.3 PCI Card Installation

Step 1: Unfasten the two screws on the rear panel.

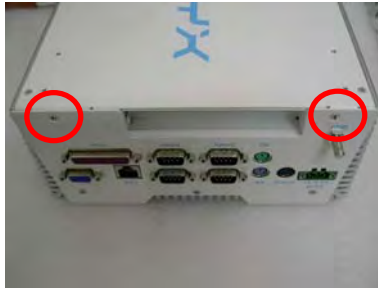

Step 2: Unfasten three screws on the front panel.



Step 3: Unfasten the six screws on the bottom lid.



Step 4: Remove the screw with your finger (figure 1) and get the PCI card ready to install. You should keep the shield and screw for use later.

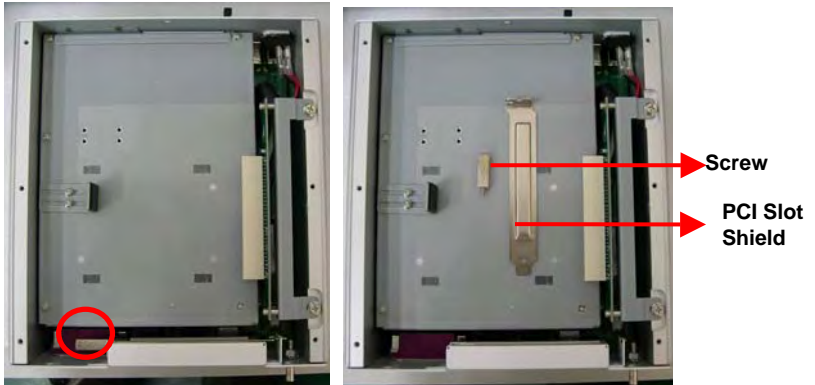

Figure 1

Step 5: Insert the PCI card into the PCI slot and reattach the screw.



Step 6: Unfasten the screws (Figure 1) and push the tenon to lock the PCI card in position (Figure 2).



Figure 1



Figure 2

Step 7: Close the bottom lid of the ONYX-6910 and fasten six screws on bottom lid.



Step 8: Fasten the three screws on the front panel and the two screws on the rear panel.



2.4 Wallmount Kit Installation

Step 1: Get the brackets ready and fasten appropriate four screws on each bracket.



Step 2: After fastening the two brackets on the bottom lid of ONYX-6910, the wallmount kit installation is finished.

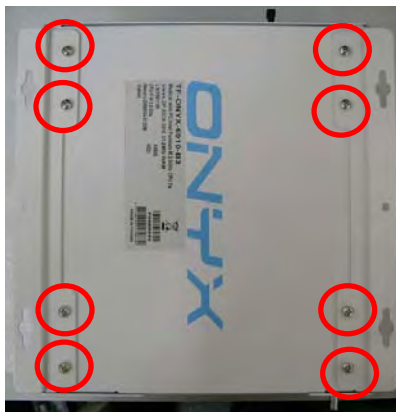

Chapter

3

**Award
BIOS Setup**

3.1 System Test and Initialization

These routines test and initialize board hardware. If the routines encounter an error during the tests, you will either hear a few short beeps or see an error message on the screen. There are two kinds of errors: fatal and non-fatal. The system can usually continue the boot up sequence with non-fatal errors. Non-fatal error messages usually appear on the screen along with the following instructions:

Press <F1> to RESUME

Write down the message and press the F1 key to continue the boot up sequence.

System configuration verification

These routines check the current system configuration against the values stored in the CMOS memory. If they do not match, the program outputs an error message. You will then need to run the BIOS setup program to set the configuration information in memory.

There are three situations in which you will need to change the CMOS settings:

1. You are starting your system for the first time
2. You have changed the hardware attached to your system
3. The CMOS memory has lost power and the configuration information has been erased.

The ONYX-6910 CMOS memory has an integral lithium battery backup for data retention. However, you will need to replace the complete unit when it finally runs down.

3.2 Award BIOS Setup

Awards BIOS ROM has a built-in Setup program that allows users to modify the basic system configuration. This type of information is stored in battery-backed CMOS RAM so that it retains the Setup information when the power is turned off.

Entering Setup

Power on the computer and press immediately. This will allow you to enter Setup.



Standard CMOS Features

Use this menu for basic system configuration. (Date, time, IDE, etc.)

Advanced BIOS Features

Use this menu to set the advanced features available on your system.

Advanced Chipset Features

Use this menu to change the values in the chipset registers and optimize your system performance.

Integrated Peripherals

Use this menu to specify your settings for integrated peripherals. (Primary slave, secondary slave, keyboard, mouse etc.)

Power Management Setup

Use this menu to specify your settings for power management. (HDD power down, power on by ring, KB wake up, etc.)

PnP/PCI Configurations

This entry appears if your system supports PnP/PCI.

PC Health Status

This menu allows you to set the shutdown temperature for your system.

Frequency/Voltage Control

Use this menu to specify your settings for auto detect DIMM/PCI clock and spread spectrum.

Load Fail-Safe Defaults

Use this menu to load the BIOS default values for the minimal/stable performance for your system to operate.

Load Optimized Defaults

Use this menu to load the BIOS default values that are factory settings for optimal performance system operations. While AWARD has designated the custom BIOS to maximize performance, the factory has the right to change these defaults to meet their needs.

Set Supervisor/User Password

Use this menu to set Supervisor/User Passwords.

Save and Exit Setup

Save CMOS value changes to CMOS and exit setup.

Exit Without Saving

Abandon all CMOS value changes and exit setup.

You can refer to the "AAEON BIOS Item Description.pdf" file in the CD for the meaning of each setting in this chapter.

Chapter

4

**Driver
Installation**

The ONYX-6910 comes with a CD-ROM that contains all drivers and utilities that meet your needs.

Follow the sequence below to install the drivers:

- Step 1 – Install INF Driver
- Step 2 – Install VGA Driver
- Step 3 – Install LAN Driver
- Step 4 – Install Audio Driver

USB 2.0 Drivers are available for download using Windows Update for both Windows XP and Windows 2000. For additional information regarding USB 2.0 support in Windows XP and Windows 2000, please visit www.microsoft.com/hwdev/usb/.

Please read instructions below for further detailed installations.

4.1 Installation

Insert the ONYX-6910 CD-ROM into the CD-ROM Drive. The Autorun program will run automatically. You also can choose the drivers to install from step 1 to step 4 in order as following instructions.

Step 1 – Install INF Driver

1. Click on the **INF Driver** folder and then double click on the **setup.exe**
2. Follow the instructions that the window will show you.
3. The system will help you install the driver automatically.

Step 2 – Install VGA Driver

1. Click on the **VGA Driver** folder and then double click on the **setup.exe**.
2. Follow the instructions that the window will show you.
3. The system will help you install the driver automatically.

Step 3 – Install LAN Driver

1. Click on **Start** button → **Settings** → **Control Panel** → **System**
2. Select **Device Manager** under the **Hardware** category.
3. Double click on the **Ethernet controller** and select **reinstall Driver** button under the **General** category.
4. Click **Next** twice and tick the **Specify a location option**.
5. Click **Next** and choose a route where you want place the folders on before you click on **Open**.

6. Click **Next** → **Yes** → **Finish** and the window will show you how to finish the installation process.

Step 4 – Install Audio Driver

1. Click on the **Audio Driver** folder and then double click on the **setup.exe**
2. Follow the instructions that the window will show you.
3. The system will help you install the driver automatically.

Note:

Under the Window OS environment, if the CRT connector is connected to display monitor by the data switch device, the user need to set the color and resolution from Intel Graphic utility (VGA driver) instead of setting from the control panel in case of the wrong display appearance.

Appendix

A

**Programming the
Watchdog Timer**

A.1 Programming

ONYX-6910 utilizes the ITE 8712 chipset as its watchdog timer controller. Below are the procedures to complete its configuration and the AAeon initial watchdog timer program is also attached with which you can develop a customized program to fit your application.

Configuring Sequence Description

After the hardware reset or power-on reset, the ITE 8712 enters the normal mode with all logical devices disabled except KBC. The initial state (enable bit) of this logical device (KBC) is determined by the state of pin 121 (DTR1#) at the falling edge of the system reset during power-on reset.

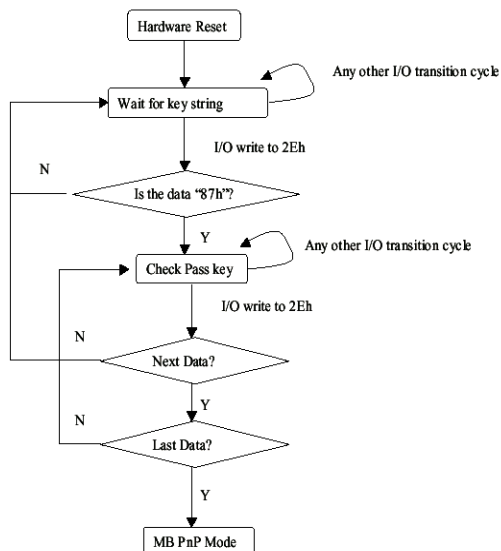

There are three steps to complete the configuration setup:

(1) Enter the MB PnP Mode; (2) Modify the data of configuration registers; (3) Exit the MB PnP Mode. Undesired result may occur if the MB PnP Mode is not exited normally.

(1) Enter the MB PnP Mode

To enter the MB PnP Mode, four special I/O write operations are to be performed during Wait for Key state. To ensure the initial state of the key-check logic, it is necessary to perform four write operations to the Special Address port (2EH). Two different enter keys are provided to select configuration ports (2Eh/2Fh) of the next step.

	Address Port	Data Port
87h, 01h, 55h, 55h:	2Eh	2Fh

(2) Modify the Data of the Registers

All configuration registers can be accessed after entering the MB PnP Mode. Before accessing a selected register, the content of Index 07h must be changed to the LDN to which the register belongs, except some Global registers.

(3) Exit the MB PnP Mode

Set bit 1 of the configure control register (Index=02h) to 1 to exit the MB PnP Mode.

WatchDog Timer Configuration Registers**LDN Index R/W Reset Configuration Register or Action**

All	02H	W	N/A	Configure Control
07H	71H	R/W	00H	WatchDog Timer Control Register
07H	72H	R/W	00H	WatchDog Timer Configuration Register
07H	73H	R/W	00H	WatchDog Timer Time-out Value Register

Configure Control (Index=02h)

This register is write only. Its values are not sticky; that is to say, a hardware reset will automatically clear the bits, and does not require the software to clear them.

Bit Description

7-2	Reserved
1	Returns to the Wait for Key state. This bit is used when the configuration sequence is completed
0	Resets all logical devices and restores configuration registers to their power-on states.

WatchDog Timer Control Register (Index=71h, Default=00h)

Bit	Description
7	WDT is reset upon a CIR interrupt
6	WDT is reset upon a KBC (mouse) interrupt
5	WDT is reset upon a KBC (keyboard) interrupt
4	WDT is reset upon a read or a write to the Game Port base address
3-2	Reserved
1	Force Time-out. This bit is self-clearing
0	WDT Status
	1: WDT value reaches 0.
	0: WDT value is not 0

WatchDog Timer Configuration Register (Index=72h, Default=00h)

Bit	Description
7	WDT Time-out value select
	1: Second
	0: Minute
6	WDT output through KRST (pulse) enable
5-4	Reserved
3-0	Select the interrupt level ^{Note} for WDT

WatchDog Timer Time-out Value Register (Index=73h, Default=00h)

Bit	Description
7-0	WDT Time-out value 7-0

A.2 IT8712 Watchdog Timer Initial Program

```
.MODEL SMALL
```

```
.CODE
```

Main:

```
CALL Enter_Configuration_mode
```

```
CALL Check_Chip
```

```
mov cl, 7
```

```
call Set_Logic_Device
```

```
;time setting
```

```
mov cl, 10 ; 10 Sec
```

```
dec al
```

Watch_Dog_Setting:

```
;Timer setting
```

```
mov al, cl
```

```
mov cl, 73h
```

```
call Superio_Set_Reg
```

```
;Clear by keyboard or mouse interrupt
```

```
mov al, 0f0h
```

```
mov cl, 71h
```

```
call Superio_Set_Reg
```

```
;unit is second.
```

```
mov al, 0C0H
```

```
mov cl, 72h
```

```
call Superio_Set_Reg
```

```
; game port enable  
mov cl, 9  
call Set_Logic_Device
```

```
Initial_OK:  
CALL Exit_Configuration_mode  
MOV AH,4Ch  
INT 21h
```

```
Enter_Configuration_Mode PROC NEAR  
MOV SI,WORD PTR CS:[Offset Cfg_Port]
```

```
MOV DX,02Eh  
MOV CX,04h  
Init_1:  
MOV AL,BYTE PTR CS:[SI]  
OUT DX,AL  
INC SI  
LOOP Init_1  
RET  
Enter_Configuration_Mode ENDP
```

```
Exit_Configuration_Mode PROC NEAR  
MOV AX,0202h  
CALL Write_Configuration_Data
```

RET

Exit_Configuration_Mode ENDP

Check_Chip PROC NEAR

MOV AL,20h

CALL Read_Configuration_Data

CMP AL,87h

JNE Not_Initial

MOV AL,21h

CALL Read_Configuration_Data

CMP AL,12h

JNE Not_Initial

Need_Initial:

STC

RET

Not_Initial:

CLC

RET

Check_Chip ENDP

Read_Configuration_Data PROC NEAR

MOV DX,WORD PTR CS:[Cfg_Port+04h]

OUT DX,AL

```
MOV DX,WORD PTR CS:[Cfg_Port+06h]
IN AL,DX
RET
Read_Configuration_Data ENDP
```

```
Write_Configuration_Data PROC NEAR
MOV DX,WORD PTR CS:[Cfg_Port+04h]
OUT DX,AL
XCHG AL,AH
MOV DX,WORD PTR CS:[Cfg_Port+06h]
OUT DX,AL
RET
Write_Configuration_Data ENDP
```

```
Superio_Set_Reg proc near
push ax
MOV DX,WORD PTR CS:[Cfg_Port+04h]
mov al,cl
out dx,al
pop ax
inc dx
out dx,al
ret
Superio_Set_Reg endp.Set_Logic_Device proc near
Set_Logic_Device proc near
```

```
push ax
push cx
xchg al,cl
mov cl,07h
call Superio_Set_Reg
pop cx
pop ax
ret
Set_Logic_Device endp
```

```
;Select 02Eh->Index Port, 02Fh->Data Port
Cfg_Port DB 087h,001h,055h,055h
```

```
DW 02Eh,02Fh
```

END Main

Note: Interrupt level mapping

0Fh-Dh: not valid

0Ch: IRQ12

.

.

03h: IRQ3

02h: not valid

01h: IRQ1

00h: no interrupt selected

Appendix

B

I/O Information

B.1 I/O Address Map

Input/output (IO)	
[00000000 - 0000000F]	Direct memory access controller
[00000020 - 00000021]	Programmable interrupt controller
[00000022 - 0000003F]	PCI bus
[00000040 - 00000043]	System timer
[00000044 - 00000047]	PCI bus
[0000004C - 0000006F]	PCI bus
[00000060 - 00000060]	PC/AT Enhanced P5/2 Keyboard (101/102-Key)
[00000061 - 00000061]	System speaker
[00000064 - 00000064]	PC/AT Enhanced P5/2 Keyboard (101/102-Key)
[00000070 - 00000071]	System CMOS/real time clock
[00000072 - 0000007F]	PCI bus
[00000081 - 00000083]	Direct memory access controller
[00000087 - 00000087]	Direct memory access controller
[00000089 - 0000008B]	Direct memory access controller
[0000008F - 00000091]	Direct memory access controller
[00000090 - 00000091]	PCI bus
[00000093 - 0000009F]	PCI bus
[000000A0 - 000000A1]	Programmable interrupt controller
[000000A2 - 000000BF]	PCI bus
[000000C0 - 000000DF]	Direct memory access controller
[000000E0 - 000000EF]	PCI bus
[000000F0 - 000000FF]	Numeric data processor
[00000100 - 00000CF7]	PCI bus
[00000170 - 00000177]	Secondary IDE Channel
[000001F0 - 000001F7]	Primary IDE Channel
[00000274 - 00000277]	ISAPNP Read Data Port
[00000279 - 00000279]	ISAPNP Read Data Port
[000002E8 - 000002EF]	Communications Port (COM4)
[000002F8 - 000002FF]	Communications Port (COM2)
[00000376 - 00000376]	Secondary IDE Channel
[00000378 - 0000037F]	Printer Port (LPT1)
[000003B0 - 000003BB]	Intel(R) 82852/82855 GM/GME Graphics Controller
[000003C0 - 000003DF]	Intel(R) 82852/82855 GM/GME Graphics Controller
[000003E8 - 000003EF]	Communications Port (COM3)
[000003F0 - 000003F5]	Standard floppy disk controller
[000003F6 - 000003F6]	Primary IDE Channel
[000003F7 - 000003F7]	Standard Floppy disk controller
[000003F8 - 000003FF]	Communications Port (COM1)
[00000500 - 0000051F]	Intel(R) 82801DB/DBM SMBus Controller - 24C3
[00000778 - 0000077F]	Printer Port (LPT1)
[00000A79 - 00000A79]	ISAPNP Read Data Port
[00000D00 - 0000FFFF]	PCI bus
[0000D000 - 0000D03F]	Intel(R) 825xER PCI Adapter
[0000E000 - 0000E01F]	Intel(R) 82801DB/DBM USB Universal Host Controller - 24C2
[0000E100 - 0000E11F]	Intel(R) 82801DB/DBM USB Universal Host Controller - 24C4
[0000E200 - 0000E207]	Intel(R) 82852/82855 GM/GME Graphics Controller
[0000E400 - 0000E4FF]	Realtek AC'97 Audio
[0000E500 - 0000E53F]	Realtek AC'97 Audio
[0000F000 - 0000F00F]	Intel(R) 82801DB Ultra ATA Storage Controller - 24CB
[0000FB00 - 0000FBFF]	Texas Instruments PCI-1420 CardBus Controller
[0000FC00 - 0000FCFF]	Texas Instruments PCI-1420 CardBus Controller
[0000FDFC - 0000FDFD]	Texas Instruments PCI-1420 CardBus Controller
[0000FDFE - 0000FDFE]	Texas Instruments PCI-1420 CardBus Controller
[0000FE00 - 0000FEFF]	Texas Instruments PCI-1420 CardBus Controller
[0000FF00 - 0000FFFF]	Texas Instruments PCI-1420 CardBus Controller

B.2 Memory Address Map

Address Range	Device
[00000000 - 0009FFFF]	System board
[000A0000 - 000BFFFF]	Intel(R) 82852/82855 GM/GME Graphics Controller
[000A0000 - 000BFFFF]	PCI bus
[000CC800 - 000CFFFF]	PCI bus
[000D4000 - 000DFFFF]	PCI bus
[000DE000 - 000DEFFF]	Texas Instruments PCI-1420 CardBus Controller
[000DF000 - 000DFFFF]	Texas Instruments PCI-1420 CardBus Controller
[000F0000 - 000F3FFF]	Motherboard resources
[000F4000 - 000F7FFF]	Motherboard resources
[000F8000 - 000FBFFF]	Motherboard resources
[000FC000 - 000FFFFF]	Motherboard resources
[00100000 - 00FFFFFF]	System board
[0E000000 - FEBFFFFF]	PCI bus
[D8000000 - DFFFFFFF]	Intel(R) 82852/82855 GM/GME Graphics Controller
[E0000000 - E7FFFFFF]	Intel(R) 82852/82855 GM/GME Graphics Controller
[E8000000 - E801FFFF]	Intel(R) 8255xER PCI Adapter
[E8030000 - E8030FFF]	Texas Instruments PCI-1420 CardBus Controller
[E8035000 - E8035FFF]	Texas Instruments PCI-1420 CardBus Controller
[E803A000 - E803AFFF]	Intel(R) 8255xER PCI Adapter
[E8100000 - E817FFFF]	Intel(R) 82852/82855 GM/GME Graphics Controller
[E8180000 - E81FFFFF]	Intel(R) 82852/82855 GM/GME Graphics Controller
[E8200000 - E82003FF]	Intel(r) 82801DB/DBM USB Enhanced Host Controller
[E8201000 - E82011FF]	Realtek AC'97 Audio
[E8202000 - E82020FF]	Realtek AC'97 Audio
[FE600000 - FE7FFFFFFF]	Texas Instruments PCI-1420 CardBus Controller
[FE800000 - FE9FFFFFFF]	Texas Instruments PCI-1420 CardBus Controller
[FEBFD000 - FEBDFFFF]	Texas Instruments PCI-1420 CardBus Controller
[FEBFE000 - FEBFEFFF]	Texas Instruments PCI-1420 CardBus Controller
[FEBFFC00 - FEBFFFFF]	Intel(R) 82801DB Ultra ATA Storage Controller - 24CB
[FEC00000 - FEC0FFFF]	System board
[FEE00000 - FEE0FFFF]	System board
[FFB00000 - FFB7FFFF]	System board
[FFB80000 - FFBFFFFFFF]	Intel(r) 82802 Firmware Hub Device
[FFF00000 - FFFFFFFF]	System board

B.3 IRQ Mapping Chart

Interrupt request (IRQ)	
(ISA) 0	System timer
(ISA) 1	PC/AT Enhanced PS/2 Keyboard (101/102-Key)
(ISA) 3	Communications Port (COM2)
(ISA) 4	Communications Port (COM1)
(ISA) 6	Standard floppy disk controller
(ISA) 8	System CMOS/real time clock
(ISA) 10	Communications Port (COM3)
(ISA) 11	Communications Port (COM4)
(ISA) 12	Logitech PS/2 Port Mouse
(ISA) 13	Numeric data processor
(ISA) 14	Primary IDE Channel
(ISA) 15	Secondary IDE Channel
(PCI) 5	Intel (r) 82801DB/DBM USB Enhanced Host Controller
(PCI) 5	Intel(R) 8255xER PCI Adapter
(PCI) 5	Intel(R) 82801DB/DBM SMBus Controller - 24C3
(PCI) 5	Realtek AC'97 Audio
(PCI) 5	Texas Instruments PCI-1420 CardBus Controller
(PCI) 9	Intel(R) 82801DB/DBM USB Universal Host Controller - 24C2
(PCI) 9	Intel(R) 82801DB/DBM USB Universal Host Controller - 24C4
(PCI) 9	Intel(R) 82852/82855 GM/GME Graphics Controller
(PCI) 9	Texas Instruments PCI-1420 CardBus Controller

B.4 DMA Channel Assignments

Direct memory access (DMA)	
2	Standard floppy disk controller
4	Direct memory access controller