

FWS-7600

1U Rackmount

Network Appliance Platform

1 ATA-100, 2 SATA II

6 USB Ports, Mini PCI

Copyright Notice

This document is copyrighted, 2008. All rights are reserved. The original manufacturer reserves the right to make improvements to the products described in this manual at any time without notice.

No part of this manual may be reproduced, copied, translated, or transmitted in any form or by any means without the prior written permission of the original manufacturer. Information provided in this manual is intended to be accurate and reliable. However, the original manufacturer assumes no responsibility for its use, or for any infringements upon the rights of third parties that may result from its use.

The material in this document is for product information only and is subject to change without notice. While reasonable efforts have been made in the preparation of this document to assure its accuracy, AAEON assumes no liabilities resulting from errors or omissions in this document, or from the use of the information contained herein.

AAEON reserves the right to make changes in the product design without notice to its users.

Acknowledgments

All other products' name or trademarks are properties of their respective owners.

- Award is a trademark of Award Software International, Inc.
- CompactFlash™ is a trademark of the Compact Flash Association.
- Intel®, Xeon Quad Core, and Core 2 Duo are trademarks of Intel® Corporation.
- Microsoft Windows® is a registered trademark of Microsoft Corp.
- ISoundBlaster is a trademark of Creative Labs, Inc.

All other product names or trademarks are properties of their respective owners.

Packing List

Before you begin installing your card, please make sure that the following materials have been shipped:

- 1 FWS-7600
- 1 Quick Installation Guide
- 1 CD-ROM for manual (in PDF format) and drivers
- 1 Heatpipe Module
- 1 Serial ATA Cable
- 1 Hard Disk Drive Power Cable
- 2 Ear Brackets
- Screw Accessories

If any of these items should be missing or damaged, please contact your distributor or sales representative immediately.

Note:

PS/2 keyboard/mouse cable and VGA Cable are optional accessories, please purchase those cables according to the following item numbers.

1700060150 PS/2 KB/MS Cable

Contents

Chapter 1 General Information

1.1 Introduction.....	1-2
1.2 Features	1-3
1.3 Specifications	1-4
1.4 General System Information	1-7

Chapter 2 Quick Installation Guide

2.1 Safety Precautions	2-2
2.2 Location of Connectors	2-3
2.3 Mechanical Drawing.....	2-4
2.4 List of Jumpers.....	2-7
2.5 List of Connectors	2-8
2.6 Setting Jumpers	2-9
2.7 CF Power Selection (JP3).....	2-10
2.8 Clear CMOS (JP4)	2-10
2.9 BUZZER (FP2).....	2-10
2.10 Front Panel Connector (FP1).....	2-10
2.11 Front Panel Connector (FP2).....	2-10
2.12 USB Connector (USB1)	2-11
2.13 USB Pin Header (CN4, CN6).....	2-11
2.14 RS-232 Serial Port Connector (COM1).....	2-11
2.15 RS-232 Serial Port Pin Header (COM2)	2-12
2.16 Power Connector (ATX2).....	2-12

2.17 FAN Connector (FAN1, FAN2, FAN3)	2-13
2.18 PS/2 Keyboard/ Mouse Connector (CN2)	2-13
2.19 SATA Power Connector (PWR1)	2-13
2.20 LCM & Key Pad Control Connector (LCMA1)	2-13
2.21 PCIX Power Connector (CN1)	2-14
2.22 Installing the CPU and the Heatpipe	2-15
2.23 Hard Disk Drive Installation	2-20
2.24 LAN Module Installation	2-23

Chapter 3 Award BIOS Setup

3.1 System Test and Initialization	3-2
3.2 Award BIOS Setup	3-3

Chapter 4 Driver Installation

4.1 Installation	4-3
------------------------	-----

Appendix A Programming the Watchdog Timer

A.1 Programming	A-2
A.2 W83627EHG Watchdog Timer Initial Program	A-6

Appendix B I/O Information

B.1 I/O Address Map	B-2
B.2 Memory Address Map	B-3
B.3 IRQ Mapping Chart	B-4
B.4 DMA Channel Assignments	B-4

Appendix C Standard Firewall Platform Setting

C.1 Standard Firewall Platform Setting	C-2
--	-----

C.2 Status LED Sample Code..... C-3
C.3 LAN Bypass Mode Sample Code C-6
C.4 LCM Sample Code C-8
C.5 Console Redirection C-14

Chapter

1

**General
Information**

1.1 Introduction

FWS-7600 adopts Intel Xeon Quad Core 3200 series up to 2.66GHz or Core 2 Duo 3000 series Processor up to 2.4GHz. The chipset is equipped with Intel® 3010 and Intel® 82801FB (ICH7R). In addition, the system memory features four 240-pin ECC DDRII 667 SDRAM DIMM socket total up to 8GB and supports dual-channel. FWS-7600 deploys ten LAN ports that can use four PCI-E [x1] copper LAN with four ports bypass function and two PCI-E [x4] dual fiber LAN modules or features four SFP on the modules. The condensed appearance of FWS-7600 features 1U form factor that fits nicely into a space- limited environment.

This compact FWS-7600 is equipped with one ATA-100 that supports CD-ROM ATAPI devices, two SATA II and CompactFlash™ Type II connector with ATA mode. In addition, it offers flexible expansion with network products and features one Mini PCI expansion slot, six USB2.0 ports and two RS-232 console ports. The console port deploys console re-direction that increases the network security via remote control. Moreover, there is a front panel support LCM with keypad control that allows for easy access and operation. All of these designs provide for a more user-friendly solution.

1.2 Features

- 1U Network Appliance Platform Up To 10 LAN Ports
- Intel® Xeon Quad Core 3200 Series Up to 2.66GHz & Dual Core 3000 Series CPU Up To 2.4GHz
- 240-Pin Dual-Channel ECC DDRII 667 SDRAM DIMM x 4 Support Up To 8GB
- Fiber Ethernet x 4 & Gigabit Ethernet Module x 4 For Optional (4-port Bypass Function)
- Ultra ATA-100 Port x 1 & SATA II x 2
- CompactFlash Type-II Connector & Mini PCI Type-III Connector
- 300W Power With Auto Range Input
- USB2.0 Port x 6 (Pin Header x 4, Type A Port x 2 On Front Panel)
- Parallel LCM With Keypad x 1 & RS-232 Console x 1 On Front Panel
- Watchdog Function 1~255 Sec.
- Internal 3.5" Disk Drive Bay x 1

1.3 Specifications

System

Construction:	1U firewall heavy-duty steel system up to 10 ports
CPU	Intel® Xeon Quad Core 3200 series up to 2.66GHz and Dual Core 3000 series CPU up to 2.4GHz, Tc=82W @ 70°C
Memory	240-pin ECC DDRII 667 DIMM Socket x 4, total up to 8GB, Support Dual-Channel
LAN (Optional)	PCI-E [x1] 10/100/1000Mb LAN module x 4 w/ Intel 82573 (with 4-port bypass), PCI-E [x4] Dual Fiber LAN module x 2 w/Intel 82571, SFP x 4
BIOS	Award Plug & Play FWH BIOS – 8Mb ROM
IDE	ATA-100 x 1 channel (Supports CD-ROM ATAPI devices)
SATA Interface	SATA II x 2
Solid Storage Disk	Supports CFD Type II connector(ATA mode)
Note: Please change the IDE BIOS setting to “Slave” when you use the CF and IDE.	
Expansion Interface	Mini PCI Type III Socket & PCI/ PCI-X/ PCI-E [x1] slot

Watchdog Timer	1~255 steps, can be set with software on Super I/O
RTC	Internal RTC
Storage	Internal : One 3.5" Hard Disk Drive Bay
System Fan	Three 4cm Ball Bearing Fans
Color	Blue and Red
LCM	2 x16 characters with 4 keypad control
Power Supply	ATX 300W, auto range
Dimensions	16.93" (W) x 19.69" (D) x 1.73"(H) (430mm x 500mm x 44mm) —Chassis 9.84" (W) x 11.02" (D) (250mm x 280mm) —Board
Net Weight	17.6 lb (8 kg)
EMC	CE/FCC Class A
Safety	UL

I/O

Serial Port	Two COM ports: (Internal Pin Header x 1) COM 1: RS-232 COM 2: RS-232 (Pin Header)
Keyboard & Mouse	Reserve pin header
Universal Serial Bus	Six USB 2.0 Ports Two Dual Type A Connector on front panel Four Pin Header (Internal)
Front I/O Panel	One Bypass LED

	One Power LED
	One Status LED
	One HDD Active LED
	LAN LEDs
	Two USB Ports
	LAN Ports
	One DB-9 connector
	One LCM Display
	One Reset Button
Rear I/O panel	One PCI-E [x1] / PCI-X/ PCI expansion slot

Environmental

Operating Temp.	32° F ~ 104° F (0° C ~ 40° C)
Storage Temp.	-4° F ~ 140° F (-20° C ~ 60° C)
Operating humidity:	10 ~ 80%
Storage humidity:	10 ~ 80% @ 40° C, non-condensing
Vibration	0.5G / 5 ~ 500Hz / operation (3.5" Hard Disk Drive) 1.5G / 5 ~ 500Hz / non operation
Shock	10G peak acceleration (11 m sec. duration), operation 20G peak acceleration (11 m sec. duration), non operation

1.4 General System Information

Front Panel

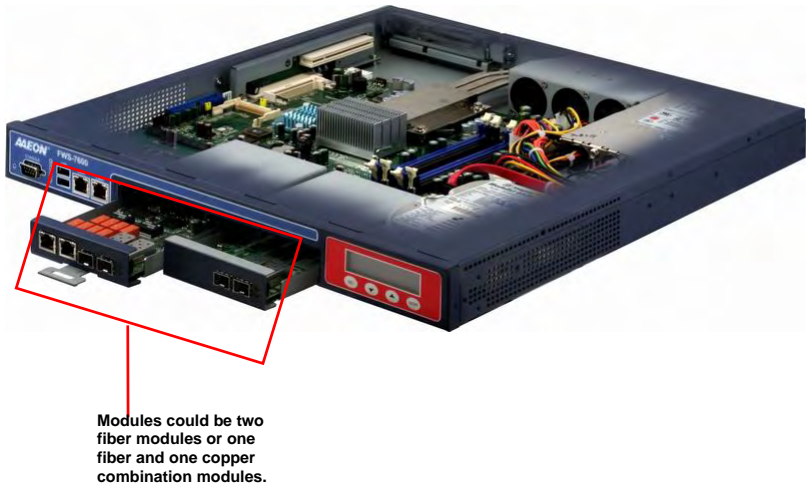
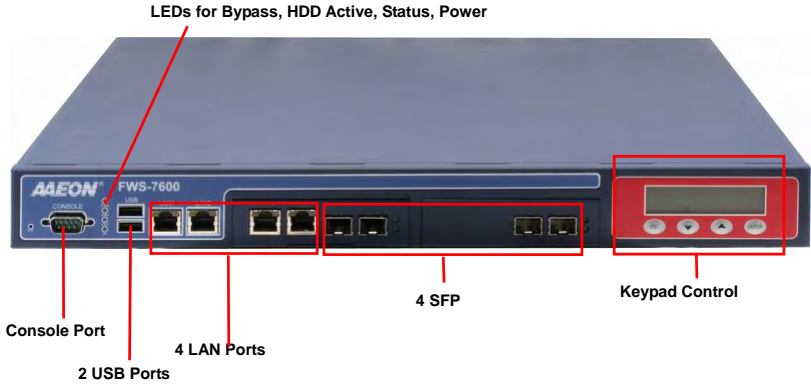

Chapter

2

FWS-7600 Quick Installation Guide

Notice:

The Quick Installation Guide is derived from Chapter 2 of the user manual. For other chapters and further installation instructions, please refer to the user manual CD-ROM that came with the product.



Part No. 2001760010 Printed in Taiwan June 2008

2.1 Safety Precautions

The installation is intended for technically qualified personnel who have experience installing and configuring system boards.

The equipment can be installed in a restricted access location (RAL) only.

A restricted access location is a site location for equipment where the following criteria apply:

01. Access can only be gained by service persons or by users who have been trained on the restrictions and the precautions for this specific site.

02. Access is by means of at least one of the following, special tool, lock and key, or other means of security, and is controlled by the authority responsible for the location.

Safety Precautions:

Warning!



Always completely disconnect the power cord from your board whenever you are working on it. Do not make connections while the power is on, because a sudden rush of power can damage sensitive electronic components.

Caution!



Always ground yourself to remove any static charge before touching the board. Modern electronic devices are very sensitive to static electric charges. Use a grounding wrist strap at all times. Place all electronic components on a static-dissipative surface or in a static-shielded bag when they are not in the chassis

2.2 Location of Connectors

Board of FWS-7600

Component side

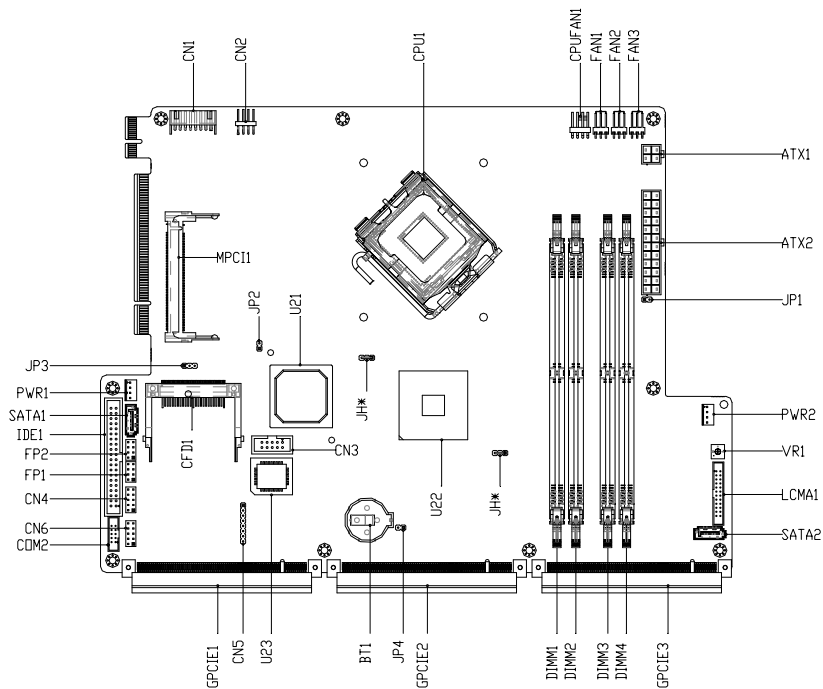

2.3 Mechanical Drawing

Board of FWS-7600

Component Side

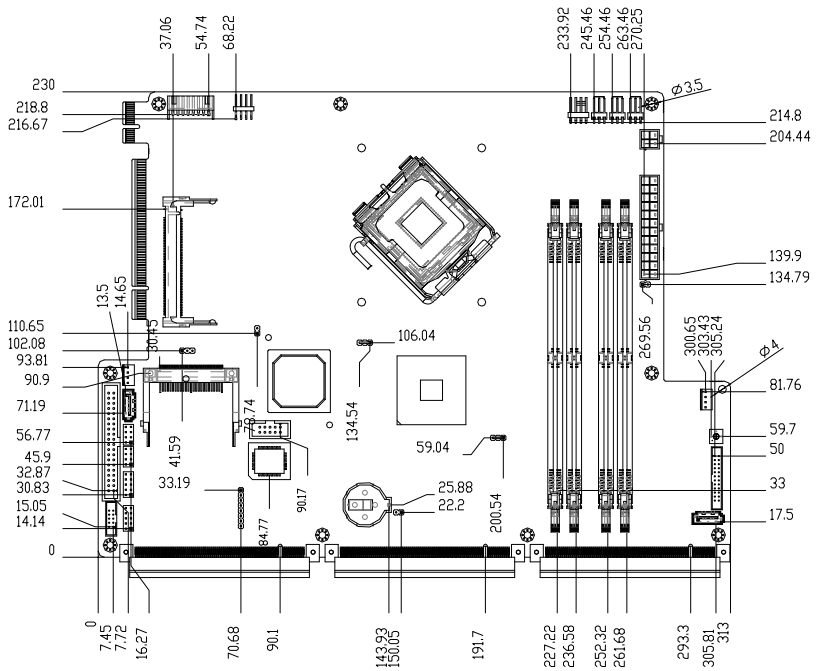

Mechanical Drawing of FWS-7600

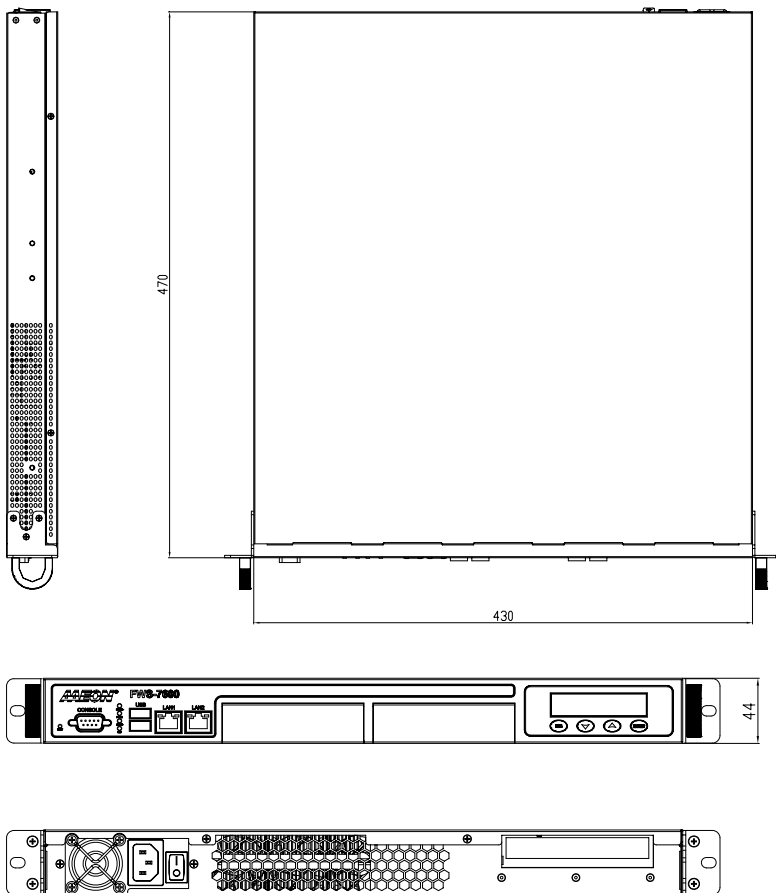

2.4 List of Jumpers

The board has a number of jumpers that allow you to configure your system to suit your application.

The table below shows the function of each of the board's jumpers:

Label	Function
JP4	Clear CMOS
JP3	CFD Power Select
FP1	Front Panel Connector 1
FP2	Front Panel Connector 2
JP2	BIOS Type Select

2.5 List of Connectors

The board has a number of connectors that allow you to configure your system to suit your application. The table below shows the function of each board's connectors:

Label	Function
ATX2	ATX Power Connector
ATX1	ATX Power_12V Connector
SATA1~2	Serial ATA Connector
IDE1	IDE Connector
USB1	USB Connector
CN4、6	USB PIN HEADER
COM1	RS-232 Serial Port Connector
COM2	RS-232 Serial Port PIN HEADER
DIMM1~4	DIMM Slot
FAN1~3	Fan Connector
CN2	PS2 Keyboard/Mouse Connector
PWR1~2	SATA POWER Connector
CFD1	Compact Flash Slot
MPC11	Mini PCI Slot
CN1	PCIX Power Connector
LCMA1	LCM & Key Pad Control PIN HEADER
LAN	LAN Connector

2.6 Setting Jumpers

You configure your card to match the needs of your application by setting jumpers. A jumper is the simplest kind of electric switch. It consists of two metal pins and a small metal clip (often protected by a plastic cover) that slides over the pins to connect them. To “close” a jumper you connect the pins with the clip.

To “open” a jumper you remove the clip. Sometimes a jumper will have three pins, labeled 1, 2 and 3. In this case you would connect either pins 1 and 2 or 2 and 3.

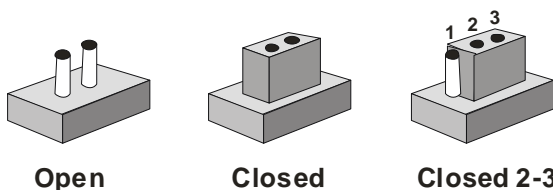

A pair of needle-nose pliers may be helpful when working with jumpers.

If you have any doubts about the best hardware configuration for your application, contact your local distributor or sales representative before you make any change.

Generally, you simply need a standard cable to make most connections.

2.7 CF Power Selection (JP3)

JP3	Function
Close 1-2	+5V (Default)
Close 2-3	+3.3V

2.8 Clear CMOS (JP4)

JP4	Function
1-2	Clear CMOS
Open	Protected (Default)

2.9 BUZZER (FP2)

FP2	Function
5-7	Enable Internal SPK (Default)
Open	Disable Internal SPK

2.10 Front Panel Connector (FP1)

Pin	Signal	Pin	Signal
1	Power On Button (+)	2	Reset Switch (+)
3	Power On Button (-)	4	Reset Switch (-)
5	IDE LED (+)	6	Power LED (+)
7	IDE LED (-)	8	Power LED (-)

2.11 Front Panel Connector (FP2)

Pin	Signal	Pin	Signal
1	External Speaker (+)	2	Keyboard Lock (+)
3	NC	4	GND

5	Internal Buzzer (-)	6	I2C Bus SMB Clock
7	External Speaker (-)	8	

Note: Internal Buzzer enable: Close Pin 5,7

2.12 USB Connector (USB1)

Pin	Signal	Pin	Signal
1	+5V	2	GND
3	USBD-	4	GND
5	USBD+	6	USBD+
7	GND	8	USBD-
9	GND	10	+5V

2.13 USB Pin Header (CN4, CN6)

Pin	Signal	Pin	Signal
1	+5V	2	GND
3	USBD-	4	GND
5	USBD+	6	USBD+
7	GND	8	USBD-
9	GND	10	+5V

2.14 RS-232 Serial Port Connector (COM1)

Pin	Signal	Pin	Signal
1	DCD	2	RXD
3	TXD	4	DTR
5	GND	6	DSR

7	RTS	8	CTS
9	RI	10	NC

2.15 RS-232 Serial Port Pin Header (COM2)

Pin	Signal	Pin	Signal
1	DCD	2	RXD
3	TXD	4	DTR
5	GND	6	DSR
7	RTS	8	CTS
9	RI	10	NC

2.16 Power Connector (ATX2)

Pin	Signal	Pin	Signal
1	+3.3V	2	+3.3V
3	GND	4	+5V
5	GND	6	+5V
7	GND	8	PWROK
9	+5VSB	10	+12V
11	+12V	12	+3.3V
13	+3.3V	14	-12V
15	GND	16	PS_ON
17	GND	18	GND
19	GND	20	NC
21	+5V	22	+5V

23	+5V	24	GND
----	-----	----	-----

2.17 FAN Connector (FAN1, FAN2, FAN3)

Pin	Signal	Pin	Signal
1	GND	2	+12V
3	SENCE		

2.18 PS/2 Keyboard/ Mouse Connector (CN2)

CN2	Function
1	KB_DATA
2	KB_CLK
3	GND
4	+5V
5	MS_DATA
6	MS_CLK
7	NC
8	NC

2.19 SATA Power Connector (PWR1)

Pin	Signal	Pin	Signal
1	+12V	2	GND
3	GND	4	+5V

2.20 LCM & Key Pad Control Connector (LCMA1)

Pin	Signal	Pin	Signal
1	POWER	2	GND

3	LSLIN-	4	VEE
5	LAFD-	6	LINIT-
7	LPD1	8	LPD0
9	LPD3	10	LPD2
11	LPD5	12	LPD4
13	LPD7	14	LPD6
15	LCD-	16	VCC
17	UP	18	RIGHT
19	LEFT	20	DOWN
21	RESET	22	NC
23	NC	24	NC

2.21 PCIX Power Connector (CN1)

Pin	Signal	Pin	Signal
1	GND	2	+3.3V
3	+3.3V	4	+3.3V
5	-12V	6	+5V
7	+5V	8	GND

2.22 Installing the CPU and the Heatpipe

Step 1: Loosen the two screws

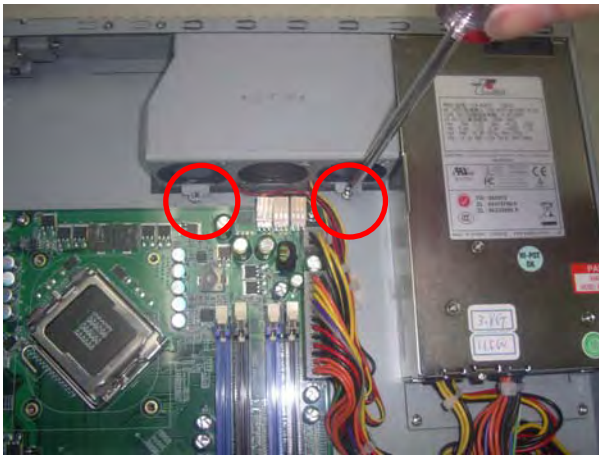

Step 2: Lift up the fan module aside



Step 3: Lift up the socket

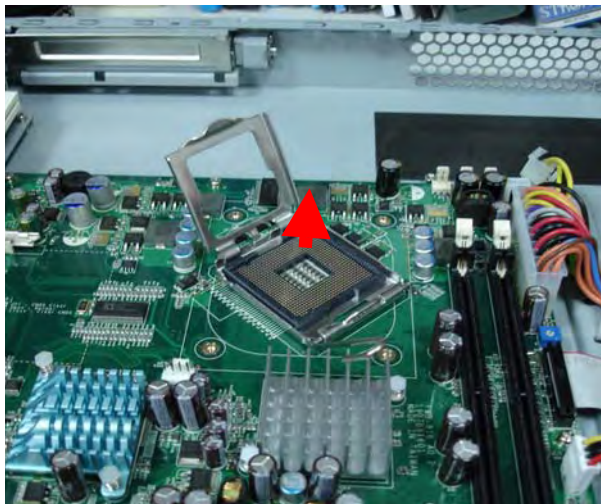

Step 4: Put the CPU on the socket

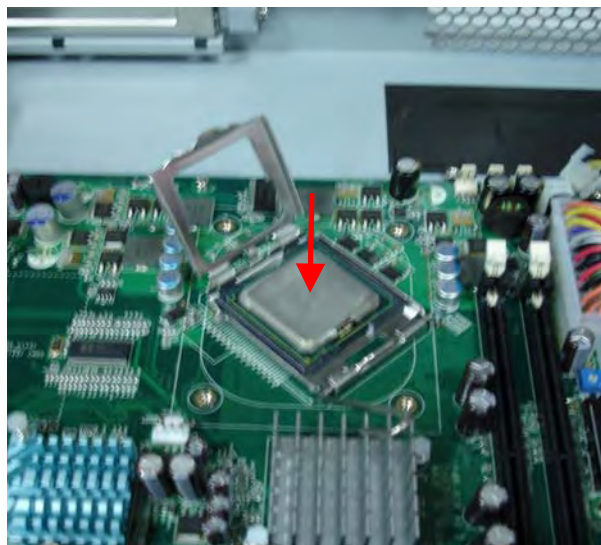

Step 5: Lock the CPU Socket

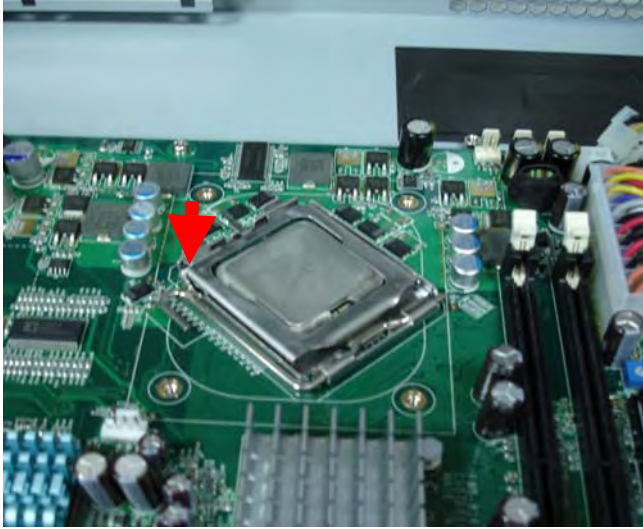

Step 6: The heatpipe module is already with thermal paste

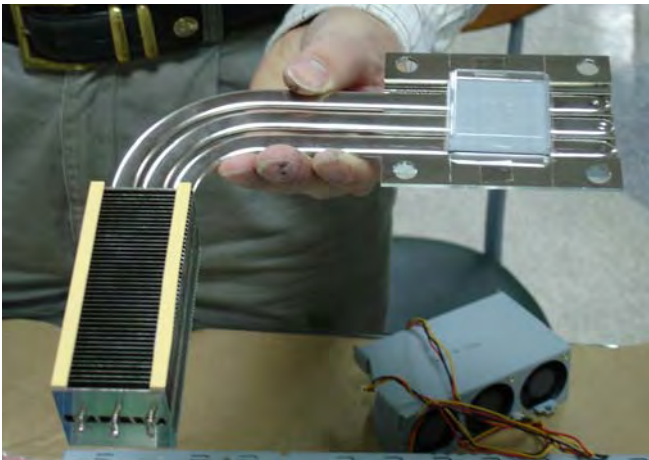

Step 7: Remove the transparent cap



Step 8: Put the heatpipe on the motherboard where the socket has already been put on CPU in the chassis



Step 9: Be sure the heatpipe has been put in the right position against the vent properly

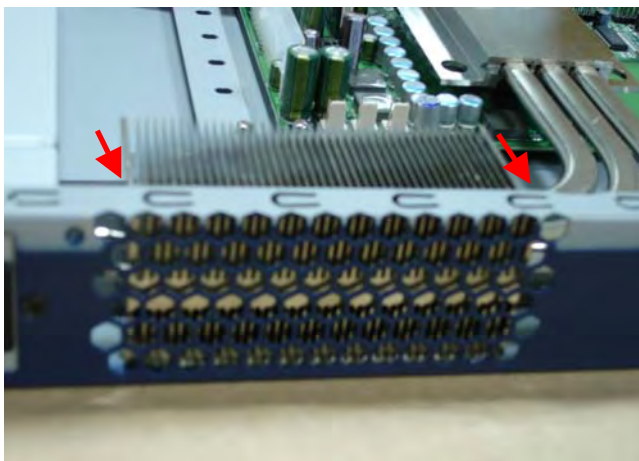

Step 10: Fasten the four screws of the heatpipe

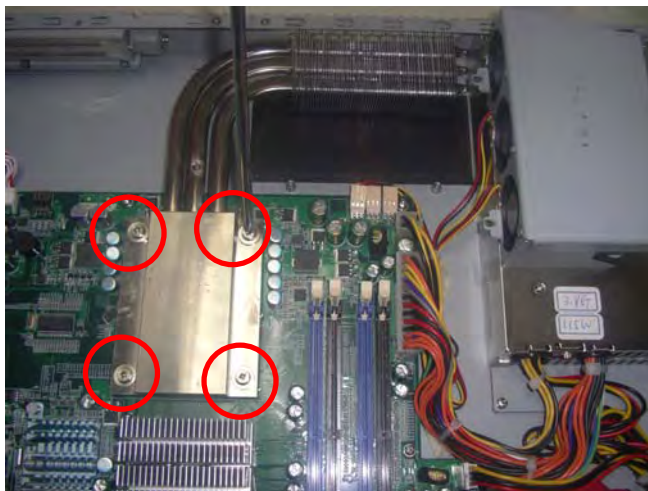

Step 11: Put the fan module back to the original place, and fasten these two screws of the fan module



2.23 Hard Disk Drive Installation

Step 1: Loosen the screw



Step 2: Lift up the hard disk drive bracket aside

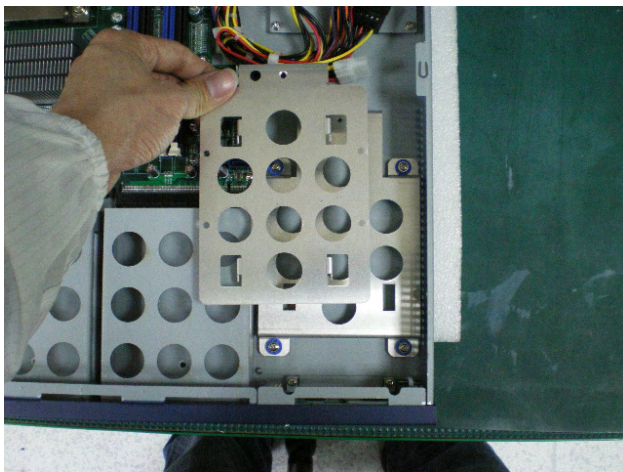

Step 3: Fasten the hard disk in the driver bay by using the four screws



Step 4: Lift down the hard disk drive and push into the bracket



Step 5: Fasten the hard disk driver bay by using the screws



Step 6: Connect the SATA cable and power cable into the Hard Disk



2.24 LAN Module Installation

Step 1: Loosen the screws on the lower case of the chassis



Step 2: Remove the null Module cover or LAN module



Step 3: Insert the LAN Module and fasten the screws



Below Table for China RoHS Requirements

产品中有毒有害物质或元素名称及含量

AAEON Boxer/ Industrial System

部件名称	有毒有害物质或元素					
	铅 (Pb)	汞 (Hg)	镉 (Cd)	六价铬 (Cr(VI))	多溴联苯 (PBB)	多溴二苯醚 (PBDE)
印刷电路板 及其电子组件	×	○	○	○	○	○
外部信号 连接器及线材	×	○	○	○	○	○
外壳	×	○	○	○	○	○
中央处理器 与内存	×	○	○	○	○	○
硬盘	×	○	○	○	○	○
电源	×	○	○	○	○	○
<p>O: 表示该有毒有害物质在该部件所有均质材料中的含量均在 SJ/T 11363-2006 标准规定的限量要求以下。</p> <p>X: 表示该有毒有害物质至少在该部件的某一均质材料中的含量超出 SJ/T 11363-2006 标准规定的限量要求。</p> <p>备注： 一、此产品所标示之环保使用期限，系指在一般正常使用状况下。 二、上述部件物质中央处理器、内存、硬盘、电源为选购品。</p>						

Chapter

3

**Award
BIOS Setup**

3.1 System Test and Initialization

These routines test and initialize board hardware. If the routines encounter an error during the tests, you will either hear a few short beeps or see an error message on the screen. There are two kinds of errors: fatal and non-fatal. The system can usually continue the boot up sequence with non-fatal errors. Non-fatal error messages usually appear on the screen along with the following instructions:

Press <F1> to RESUME

Write down the message and press the F1 key to continue the boot up sequence.

System configuration verification

These routines check the current system configuration against the values stored in the CMOS memory. If they do not match, the program outputs an error message. You will then need to run the BIOS setup program to set the configuration information in memory.

There are three situations in which you will need to change the CMOS settings:

1. You are starting your system for the first time
2. You have changed the hardware attached to your system
3. The CMOS memory has lost power and the configuration information has been erased.

The FWS-7600 CMOS memory has an integral lithium battery backup for data retention. However, you will need to replace the complete unit when it finally runs down.

3.2 Award BIOS Setup

Awards BIOS ROM has a built-in Setup program that allows users to modify the basic system configuration. This type of information is stored in battery-backed CMOS RAM so that it retains the Setup information when the power is turned off.

Entering Setup

Power on the computer and press immediately. This will allow you to enter Setup.



Standard CMOS Features

Use this menu for basic system configuration. (Date, time, IDE, etc.)

Advanced BIOS Features

Use this menu to set the advanced features available on your system.

Advanced Chipset Features

Use this menu to change the values in the chipset registers and optimize your system performance.

Integrated Peripherals

Use this menu to specify your settings for integrated peripherals. (Primary slave, secondary slave, keyboard, mouse etc.)

Power Management Setup

Use this menu to specify your settings for power management. (HDD power down, power on by ring, KB wake up, etc.)

PnP/PCI Configurations

This entry appears if your system supports PnP/PCI.

PC Health Status

This menu allows you to set the shutdown temperature for your system.

Frequency/Voltage Control

Use this menu to specify your settings for auto detect DIMM/PCI clock and spread spectrum.

Load Fail-Safe Defaults

Use this menu to load the BIOS default values for the minimal/stable performance for your system to operate.

Load Optimized Defaults

Use this menu to load the BIOS default values that are factory settings for optimal performance system operations. While AWARD has designated the custom BIOS to maximize performance, the factory has the right to change these defaults to meet their needs.

Set Supervisor/User Password

Use this menu to set Supervisor/User Passwords.

Save and Exit Setup

Save CMOS value changes to CMOS and exit setup.

Exit Without Saving

Abandon all CMOS value changes and exit setup.

You can refer to the "AAEON BIOS Item Description.pdf" file in the CD for the meaning of each setting in this chapter.

Chapter

4

**Driver
Installation**

The FWS-7600 comes with an AutoRun CD-ROM that contains all drivers and utilities that can help you to install the driver automatically.

Insert the driver CD, the driver CD-title will auto start and show the installation guide. If not, please follow the sequence below to install the drivers.

Follow the sequence below to install the drivers:

Step 1 – Install INF Driver

Step 2 – Install LAN Driver

USB 2.0 Drivers are available for download using Windows[®] Update for both Windows[®] XP and Windows[®] 2000. For additional information regarding USB 2.0 support in Windows[®] XP and Windows[®] 2000, please visit www.microsoft.com/hwdev/usb/.

Please read instructions below for further detailed installations.

4.1 Installation:

Insert the FWS-7600 CD-ROM into the CD-ROM drive and install the drivers from Step 1 to Step 2 in order.

Step 1 – Install INF Driver

1. Click on the **Step 1-*INF*** folder and double click on the **Setup** file
2. Follow the instructions that the window shows
3. The system will help you install the driver automatically

Step 2 – Install LAN Driver

1. Click on the **Step 2 –*LAN*** folder and double click on the **Autorun** file
2. Follow the instructions that the window shows
3. The system will help you install the driver automatically

Appendix

A

Programming the Watchdog Timer

A.1 Programming

FWS-7600 utilizes W83627EHG chipset as its watchdog timer controller.

Below are the procedures to complete its configuration and the AAEON initial watchdog timer program is also attached based on which you can develop customized program to fit your application.

Configuring Sequence Description

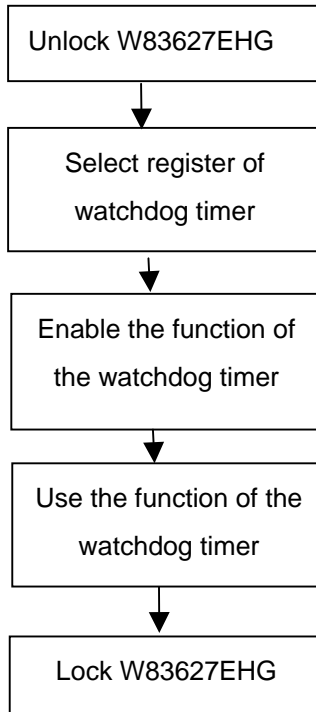

There are three steps to complete the configuration setup:

- (1) Enter the W83627EHG config Mode

- (2) Modify the data of configuration registers
- (3) Exit the W83627EHG config Mode. Undesired result may occur if the config Mode is not exited normally.

(1) Enter the W83627EHG config Mode

To enter the W83627EHG config Mode, two special I/O write operations are to be performed during Wait for Key state. To ensure the initial state of the key-check logic, it is necessary to perform two write operations to the Special Address port (2EH). The different enter keys are provided to select configuration ports (2Eh/2Fh) of the next step.

	Address Port	Data Port
87h,87h:	2Eh	2Fh

(2) Modify the Data of the Registers

All configuration registers can be accessed after entering the config Mode. Before accessing a selected register, the content of Index 07h must be changed to the LDN to which the register belongs, except some Global registers.

(3) Exit the W83627EHG config Mode

The exit key is provided to select configuration ports (2Eh/2Fh) of the next step.

	Address Port	Data Port
0aah:	2Eh	2Fh

WatchDog Timer Register I (Index=F5h, Default=00h)

CRF5 (PLED mode register. Default 0 x 00)

Bit 7-6 : select PLED mode

= 00 Power LED pin is tri-stated.

= 01 Power LED pin is driven low.

= 10 Power LED pin is a 1Hz toggle pulse with 50 duty cycle.

= 11 Power LED pin is a 1/4Hz toggle pulse with 50 duty cycle.

Bit 5-4 : Reserved

Bit 3 : select WDTO count mode.

= 0 second

= 1 minute

Bit 2 : Enable the rising edge of keyboard Reset (P20) to force Time-out event.

= 0 Disable

= 1 Enable

Bit 1-0 : Reserved

WatchDog Timer Register II (Index=F6h, Default=00h)

Bit 7-0 = 0 x 00 Time-out Disable

= 0 x 01 Time-out occurs after 1
second/minute

= 0 x 02 Time-out occurs after 2
second/minutes

= 0 x 03 Time-out occurs after 3
second/minutes

.....

= 0 x FF Time-out occurs after 255

second/minutes

WatchDog Timer Register III (Index=F7h, Default=00h)

- Bit 7** : Mouse interrupt reset Enable or Disable
- = 1 Watchdog Timer is reset upon a Mouse interrupt
 - = 0 Watchdog Timer is not affected by Mouse interrupt
- Bit 6** : Keyboard interrupt reset Enable or Disable
- = 1 Watchdog Timer is reset upon a Keyboard interrupt
 - = 0 Watchdog Timer is not affected by Keyboard interrupt
- Bit 5** : Force Watchdog Timer Time-out. Write Only
- = 1 Force Watchdog Timer time-out event: this bit is self-clearing
- Bit 4** : Watchdog Timer Status. R/W
- = 1 Watchdog Timer time-out occurred
 - = 0 Watchdog Timer counting
- Bit 3-0** : These bits select IRQ resource for Watchdog. Setting of 2 selects SMI.

A.2 W83627EHG Watchdog Timer Initial Program

Example: Setting 10 sec. as Watchdog timeout interval

```
;/;;;;;;;;;;;;;;;;;;;;;;;;;;;;;;;;;;;;;;;;;;;;;;;;;;;;;;;;;;;;;;;;;;;;;;;;;;;;;;;;;;;;;;;;;;;;;;;;;;;;;;;;;;;;;;;;;;;;;;;;;;;;;;;;
```

```
Mov dx,2eh           ;Enter W83627EHG config mode
```

```
Mov al,87h          (out 87h to 2eh twice)
```

```
Out dx,al
```

```
Out dx,al
```

```
;/;;;;;;;;;;;;;;;;;;;;;;;;;;;;;;;;;;;;;;;;;;;;;;;;;;;;;;;;;;;;;;;;;;;;;;;;;;;;;;;;;;;;;;;;;;;;;;;;;;;;;;;;;;;;;;;;;;;;;;;;;;;;;;;;
```

```
Mov al,07h
```

```
Out dx,al
```

```
Inc dx
```

```
Mov al,08h          ;Select Logical Device 8 (GPIO Port  
2)
```

```
Out dx,al
```

```
;/;;;;;;;;;;;;;;;;;;;;;;;;;;;;;;;;;;;;;;;;;;;;;;;;;;;;;;;;;;;;;;;;;;;;;;;;;;;;;;;;;;;;;;;;;;;;;;;;;;;;;;;;;;;;;;;;;;;;;;;;;;;;;;;;
```

```
Dec dx
```

```
Mov al,30h          ;CR30 (GP20~GP27)
```

```
Out dx,al
```

```
Inc dx
```

```
Mov al,01h          ;Activate GPIO2
```

```
Out dx,al
```

```
;/;;;;;;;;;;;;;;;;;;;;;;;;;;;;;;;;;;;;;;;;;;;;;;;;;;;;;;;;;;;;;;;;;;;;;;;;;;;;;;;;;;;;;;;;;;;;;;;;;;;;;;;;;;;;;;;;;;;;;;;;;;;;;;;;
```

```
Dec dx
```

```
Mov al,0f5h ;CRF5 (PLED mode register)
```

```
Out dx,al
```

```
Inc dx
```

```
In al,dx
```

```
And al,not 08h ;Set second as counting unit
```

```
Out dx,al
```

```
;/;;;;;;;;;;;;;;;;;;;;;;;;;;;;;;;;;;;;;;;;;;;;;;;;;;;;;;;;;;;;;;;;;;;;;;;;;;;;;;;;;;;;;;;;;;;;;;;;;;;;;;;;;;;;;;;;;;;;;;;;;;;;;;;;
```

```
Dec dx
```

```
Mov al,0f6h ; CRF6
```

```
Out dx,al
```

```
Inc dx
```

```
Mov al,10 ;Set timeout interval as 10 sec.
```

```
Out dx,al
```

```
;/;;;;;;;;;;;;;;;;;;;;;;;;;;;;;;;;;;;;;;;;;;;;;;;;;;;;;;;;;;;;;;;;;;;;;;;;;;;;;;;;;;;;;;;;;;;;;;;;;;;;;;;;;;;;;;;;;;;;;;;;;;;;;;;;
```

```
Dec dx ;Exit W83627EHG config mode
```

```
Mov al,0aah (out 0aah to 2eh once)
```

```
Out dx,al
```

```
;/;;;;;;;;;;;;;;;;;;;;;;;;;;;;;;;;;;;;;;;;;;;;;;;;;;;;;;;;;;;;;;;;;;;;;;;;;;;;;;;;;;;;;;;;;;;;;;;;;;;;;;;;;;;;;;;;;;;;;;;;;;;;;;;;
```

Appendix

B

I/O Information

B.1 I/O Address Map























A-3BD06B9D14144

- Direct memory access (DMA)
 - Input/output (IO)
 - PCI bus
 - [00000000 - 00000CF7] PCI bus
 - [00000000 - 0000000F] Direct memory access controller
 - [00000010 - 0000001F] Motherboard resources
 - [00000020 - 00000021] Programmable interrupt controller
 - [00000022 - 0000003F] Motherboard resources
 - [00000040 - 00000043] System timer
 - [00000044 - 0000005F] Motherboard resources
 - [00000060 - 00000060] Standard 101/102-Key or Microsoft Natural PS/2 Keyboard
 - [00000061 - 00000061] System speaker
 - [00000062 - 00000063] Motherboard resources
 - [00000064 - 00000064] Standard 101/102-Key or Microsoft Natural PS/2 Keyboard
 - [00000065 - 0000006F] Motherboard resources
 - [00000070 - 00000073] System CMOS/real time clock
 - [00000074 - 0000007F] Motherboard resources
 - [00000080 - 00000090] Direct memory access controller
 - [00000091 - 00000093] Motherboard resources
 - [00000094 - 0000009F] Direct memory access controller
 - [000000A0 - 000000A1] Programmable interrupt controller
 - [000000A2 - 000000BF] Motherboard resources
 - [000000C0 - 000000CF] Direct memory access controller
 - [000000E0 - 000000EF] Motherboard resources
 - [000000F0 - 000000FF] Numeric data processor
 - [00000170 - 00000177] Secondary IDE Channel
 - [000001F0 - 000001F7] Primary IDE Channel
 - [00000274 - 00000277] ISAPNP Read Data Port
 - [00000279 - 00000279] ISAPNP Read Data Port
 - [000002F8 - 000002FF] Communications Port (COM2)
 - [00000376 - 00000376] Secondary IDE Channel
 - [00000378 - 0000037F] Printer Port (LPT1)
 - [00000380 - 000003BB] Intel(R) 82945G Express Chipset Family
 - [000003C0 - 000003DF] Intel(R) 82945G Express Chipset Family
 - [000003F0 - 000003F5] Standard floppy disk controller
 - [000003F6 - 000003F6] Primary IDE Channel
 - [000003F7 - 000003F7] Standard floppy disk controller
 - [000003F8 - 000003FF] Communications Port (COM1)
 - [00000400 - 0000046F] Motherboard resources
 - [000004D0 - 000004D1] Motherboard resources
 - [00000500 - 0000051F] Intel(R) 82801G (ICH7 Family) SMBus Controller - 27DA
 - [00000778 - 0000077B] Printer Port (LPT1)
 - [00000800 - 0000087F] Motherboard resources
 - [00000A79 - 00000A79] ISAPNP Read Data Port
 - [00000D00 - 0000FFFF] PCI bus
 - Interrupt request (IRQ)
 - Memory

A-3BD06B9D14144

- Direct memory access (DMA)
 - Input/output (IO)
 - PCI bus
 - [00000000 - 00000CF7] PCI bus
 - [00000D00 - 0000FFFF] PCI bus
 - [00009000 - 00009FFF] Intel(R) 82801G (ICH7 Family) PCI Express Root Port - 27D6
 - [0000A000 - 0000AFFF] Intel(R) 82801G (ICH7 Family) PCI Express Root Port - 27D4
 - [0000B000 - 0000BFFF] Intel(R) 82801G (ICH7 Family) PCI Express Root Port - 27D2
 - [0000C000 - 0000CFFF] Intel(R) 82801G (ICH7 Family) PCI Express Root Port - 27D0
 - [0000D000 - 0000DFFF] Intel(R) 82801GR/GH/GHM (ICH7 Family) PCI Express Root Port - 27E2
 - [0000E000 - 0000EFFF] Intel(R) 82801GR/GH/GHM (ICH7 Family) PCI Express Root Port - 27E0
 - [0000FA00 - 0000FA0F] Intel(R) 82801GB/GR/GH (ICH7 Family) Serial ATA Storage Controller - 27C0
 - [0000FB00 - 0000FB1F] Intel(R) 82801G (ICH7 Family) USB Universal Host Controller - 27CB
 - [0000FC00 - 0000FC1F] Intel(R) 82801G (ICH7 Family) USB Universal Host Controller - 27CA
 - [0000FD00 - 0000FD1F] Intel(R) 82801G (ICH7 Family) USB Universal Host Controller - 27C9
 - [0000FE00 - 0000FE1F] Intel(R) 82801G (ICH7 Family) USB Universal Host Controller - 27C8
 - [0000FF00 - 0000FF07] Intel(R) 82945G Express Chipset Family
 - Interrupt request (IRQ)
 - Memory

B.2 Memory Address Map

- [-]  A-3BD06B9D14144
 - [+]  Direct memory access (DMA)
 - [+]  Input/output (IO)
 - [+]  Interrupt request (IRQ)
 - [-]  Memory
 - [+]  [00000000 - 0009FFFF] System board
 - [+]  [000A0000 - 000BFFFF] PCI bus
 - [+]  [000C0000 - 000DFFFF] PCI bus
 - [+]  [000E0000 - 000EFFFF] System board
 - [+]  [000F0000 - 000F3FFF] System board
 - [+]  [000F4000 - 000F7FFF] System board
 - [+]  [000F8000 - 000FBFFF] System board
 - [+]  [000FC000 - 000FFFFF] System board
 - [+]  [00100000 - 1F6DFFFF] System board
 - [+]  [1F6E0000 - 1F6FFFFFF] System board
 - [+]  [1F700000 - FEBFFFFFF] PCI bus
 - [+]  [FEC00000 - FEC00FFF] System board
 - [+]  [FED13000 - FED1DFFF] System board
 - [+]  [FED20000 - FED8FFFF] System board
 - [+]  [FEE00000 - FEE00FFF] System board
 - [+]  [FFB00000 - FFB7FFFF] System board
 - [+]  [FFB80000 - FFBFFFFFF] Intel(R) 82802 Firmware Hub Device
 - [+]  [FFF00000 - FFFFFFFF] System board

B.3 IRQ Mapping Chart



B.4 DMA Channel Assignments



Appendix

C

Standard Firewall Platform Setting

C.1 Standard Firewall Platform Setting

Status LED	Disable	I/O PORT 48Fh set bit 4 to 1, I/O PORT 4B8h set bit 3 to 1
	Red LED ON	I/O PORT 48Fh set bit 4 to 1, I/O PORT 4B8h set bit 3 to 0
	Red LED Blink	I/O PORT 48Fh set bit 4 to 1, I/O PORT 4B8h set bit 3 to 0 I/O PORT 49Bh set bit 4 to 1
	Green LED ON	I/O PORT 48Fh set bit 4 to 0, I/O PORT 4B8h set bit 3 to 1
	Green LED Blink	I/O PORT 48Fh set bit 4 to 0, I/O PORT 4B8h set bit 3 to 1 I/O PORT 49Bh set bit 4 to 1
LAN Bypass	Disable	I/O PORT 48Dh set bit 7 to 1, I/O PORT 48Fh set bit 2 to 0
	Force Mode	I/O PORT 48Dh set bit 7 to 0, I/O PORT 48Fh set bit 2 to 0
	Watch Dog Mode	I/O PORT 48Dh set bit 7 to 1, I/O PORT 48Fh set bit 2 to 1
LCM Function	Disable	
	378/IRQ7	
Software Reset		Press Software Reset button I/O PORT: 4B8h bit 6 will be set 1

C.2 Status LED Sample Code

Status LED Sample code

[Disabled LED Function]

```
mov dx,48Fh          ;( IO_PORT = 48Fh)
in  al,dx
or  al,00010000b ;set bit 4 -->high
out dx,al
```

```
mov dx,4B8h          ;( IO_PORT = 4B8h)
in  al,dx
or  al,00001000b ;set bit 3 -->high
out dx,al
```

[RED LED ON]

```
mov dx,48Fh          ;( IO_PORT = 48Fh)
in  al,dx
or  al,00010000b ;set bit 4 -->high
out dx,al
```

```
mov dx,4B8h          ;( IO_PORT = 4B8h)
in  al,dx
and al,11110111b ;set bit 3 -->LOW
```

```
out dx,al
```

[RED LED BLINK]

```
mov dx,48Fh          ;( IO_PORT = 48Fh)
```

```
in al,dx
```

```
or al,00010000b ;set bit 4 -->high
```

```
out dx,al
```

```
mov dx,4B8h          ;( IO_PORT = 4B8h)
```

```
in al,dx
```

```
and al,11110111b ;set bit 3 -->low
```

```
out dx,al
```

```
mov dx,49Bh          ;( IO_PORT = 49Bh)
```

```
in al,dx
```

```
or al,00010000b ;set bit 4 -->high(control blink)
```

```
out dx,al
```

[GREEN LED ON]

```
mov dx,48Fh          ;( IO_PORT = 48Fh)
```

```
in al,dx
```

```
and al,11101111b ;set bit 4 -->low
```

```
out dx,al
```

```
mov dx,4B8h          ;( IO_PORT = 4B8h)
```

```
in  al,dx
or  al,00001000b ;set bit 3 -->high
out dx,al
```

[GRN LED BLINK]

```
mov dx,48Fh          ;( IO_PORT = 48Fh)
in  al,dx
and al,11101111b ;set bit 4 -->low
out dx,al
```

```
mov dx,4B8h          ;( IO_PORT = 4B8h)
in  al,dx
or  al,00001000b ;set bit 3 -->high
out dx,al
```

```
mov dx,49Bh          ;( IO_PORT = 49Bh)
in  al,dx
or  al,00010000b ;set bit 4 -->high(control blink)
out dx,al
```

C.3 LAN Bypass Mode Sample Code

LAN BYPASS MODE Sample code

[Disable Function]

```
mov dx,48dh           ;( IO_PORT = 48dh)
in  al,dx
or  al,01000000b ;set bit 7-->high
out dx,al
```

```
mov dx,48Fh          ;( IO_PORT = 48Fh)
in  al,dx
and al,11111011b ;set bit 2-->low
out dx,al
```

[Force Mode]

```
mov dx,48dh           ;( IO_PORT = 48dh)
in  al,dx
and al,10111111b ;set bit 7-->low
out dx,al
```

```
mov dx,48Fh          ;( IO_PORT = 48Fh)
in  al,dx
and al,11111011b ;set bit 2-->low
out dx,al
```

[Watch Dog Mode]

```
mov dx,48dh                ;( IO_PORT = 48dh)
```

```
in  al,dx
```

```
or  al,01000000b ;set bit 7-->high
```

```
out dx,al
```

```
mov dx,48Fh                ;( IO_PORT = 48Fh)
```

```
in  al,dx
```

```
or  al,00000100b ;set bit 2-->high
```

```
out dx,al
```

C.4 LCM Sample Code

```
void Display_Clear()
{
    outportb(0x378, 0x01);
    wait();
    outportb(0x37A, 0xC8);
    wait();
    outportb(0x37A, 0xCA);
    wait();
}

void Return_Home()
{
    outportb(0x378, 0x02);
    wait();
    outportb(0x37A, 0xC8);
    wait();
    outportb(0x37A, 0xCA);
    wait();
}
```

```
}
```

```
void Entry_mode_set()
```

```
{
```

```
    outportb(0x378, 0x06);
```

```
    wait();
```

```
    outportb(0x37A, 0xC8);
```

```
    wait();
```

```
    outportb(0x37A, 0xCA);
```

```
    wait();
```

```
}
```

```
void Display_Off()
```

```
{
```

```
    outportb(0x378, 0x08);
```

```
    wait();
```

```
    outportb(0x37A, 0xC8);
```

```
    wait();
```

```
    outportb(0x37A, 0xCA);
```

```
        wait();
    }

void Display_On_Cursor_Off()
{
    outportb(0x378, 0x0C);
    wait();
    outportb(0x37A, 0xC8);
    wait();
    outportb(0x37A, 0xCA);
    wait();
}

void Display_On_Cursor_On()
{
    outportb(0x378, 0x0E);
    wait();
    outportb(0x37A, 0xC8);
    wait();
}
```

```
        outputb(0x37A, 0xCA);

        wait();

    }

/*****
***/

// Set the interface data length.

// Number of display line and character font.

// For 5x7 dots and 2 lines display now.

/*****
***/

void Function_Set()

{

    outputb(0x378, 0x38);

    wait();

    outputb(0x37A, 0xC8);

    wait();

    outputb(0x37A, 0xCA);
```

```
    wait();  
}
```

```
void Write_Char( char x )  
{  
    outportb(0x378, x);  
    outportb(0x37A, 0xC0);  
    wait();  
    outportb(0x37A, 0xC2);  
    wait();  
}
```

```
void Change_Line()  
{  
    outportb(0x378, 0xC0);  
    wait();  
    outportb(0x37A, 0xC8);  
    wait();  
    outportb(0x37A, 0xCA);
```

```
        wait();
    }

void wait()
{
    for (int i = 0 ; i < 0x10 ; i++)
    {
        for (int j = 0 ; j < 0x80 ; j++)
        {
            outportb(0x0EB, 0Xff);
        }
    }
}
```

C.5 Console Redirection

Console redirection allows you to maintain a system from a remote location by re-directing keyboard input and text output through the serial port. This section will tell you how to use the console redirection.

1. Please insert console cable between on FWS-816 Rev.B and remote client system.

2. Setup BIOS in FWS-816 Rev.B.

BIOS >> advanced BIOS features >> Baud Rate:
19200(Default)

BIOS >> advanced BIOS features >> Console Redirection:
Enable (Default)

Enabled	Attempt to redirect console via COM port
Disabled	Console redirection function disabled

3. Configure Console redirection on client system. This example is for Windows platform.

Step1 - Click the Start button, point to programs >> Accessories >> Communication, and click Hyper Terminal

Step2 - Enter any name for the new connection and select any icon

Step3 - Click OK

Step4 - From the connect to pull-down menu, select a COM port available on your client system and click OK

Step5 - Select Baud Rate >> 19200, Flow control >> None, Data bit >>8, Parity cheek >> None, Stop bit>>1

4. Power on FWS-816 Rev.B and it will display the BIOS information on the client system.