

PCM-4896

All-in-one AMD Geode GX1
Processor
Compact Board
With LCD, Ethernet,
Audio & 4 COMs

Copyright Notice

This document is copyrighted, 2005. All rights are reserved. The original manufacturer reserves the right to make improvements to the products described in this manual at any time without notice.

No part of this manual may be reproduced, copied, translated, or transmitted in any form or by any means without the prior written permission of the original manufacturer. Information provided in this manual is intended to be accurate and reliable. However, the original manufacturer assumes no responsibility for its use, or for any infringements upon the rights of third parties that may result from its use.

The material in this document is for product information only and is subject to change without notice. While reasonable efforts have been made in the preparation of this document to assure its accuracy, AAEON assumes no liabilities resulting from errors or omissions in this document, or from the use of the information contained herein.

AAEON reserves the right to make changes in the product design without notice to its users.

Acknowledgments

All other products' name or trademarks are properties of their respective owners.

- Award is a trademark of Award Software International, Inc.
- CompactFlash™ is a trademark of the Compact Flash Association.
- Microsoft Windows® is a registered trademark of Microsoft Corp.
- IBM, PC/AT, PS/2, and VGA are trademarks of International Business Machines Corporation.

Packing List

Before you begin installing your card, please make sure that the following materials have been shipped:

- 1 PCM-4896 CPU Card
- 1 Quick Installation Guide
- 1 CD-ROM for manual (in PDF format) and drivers

If any of these items should be missing or damaged, please contact your distributor or sales representative immediately.

Contents

Chapter 1 General Information

1.1 Introduction	1-2
1.2 Features.....	1-4
1.3 Specifications	1-5

Chapter 2 Quick Installation Guide

2.1 Safety Precautions	2-2
2.2 Location of Connectors and Jumpers	2-3
2.3 Mechanical Drawing	2-4
2.4 List of Jumpers	2-5
2.5 List of Connectors	2-6
2.6 Setting Jumpers.....	2-8
2.7 Audio Power Setting (JP2).....	2-9
2.8 Audio Output Selection (JP3).....	2-9
2.9 COM2 RS-232/422/485 Selection (JP3).....	2-9
2.10 Setup CMOS (JP6).....	2-9
2.11 Internal Buzzer Selection (JP7).....	2-10
2.12 ATX Soft-Power Switch Connector (JP8).....	2-10
2.13 LCD Driving Voltage Selection (JP10).....	2-10
2.14 LCD Clock Signal Selection (JP11).....	2-10
2.15 COM 3 / COM 4 RI Pin Voltage Selection (JP12, JP13).....	2-10
2.16 DOC Address Selection (JP14)	2-11
2.17 Audio Connector (CN1).....	2-11

2.18 IrDA Connector (CN2)	2-12
2.19 Ethernet LED Signal Connectors (CN3)	2-13
2.20 Keyboard and Mouse Connector (CN4)	2-13
2.21 Front Panel Connector (CN5)	2-14
2.22 Display Connectors (VGA1, CN6)	2-14
2.23 Serial Ports (CN7)	2-16
2.24 Digital I/O Connector (CN8)	2-17
2.25 ATX Power Connectors (CN9)	2-18
2.26 CD Audio Connector (CN10)	2-18
2.27 Floppy Drive Connector (FDD1)	2-19
2.28 IDE Hard Drive Connector (IDE1)	2-20
2.29 100Base-Tx Ethernet Connector (LAN1)	2-21
2.30 Parallel Port Connector (LPT1)	2-21
2.31 USB Connector (USB1)	2-22
2.32 DiskOnChip Socket (U40)	2-22
2.33 DiskOnChip (DOC) 2000 Installation	2-23

Chapter 3 Award BIOS Setup

3.1 System Test and Initialization	3-2
3.2 Award BIOS Setup	3-3

Chapter 4 Driver Installation

4.1 Software Drivers	4-2
4.2 Necessary to Know	4-3
4.3 Installing GX1 / CS 5530 PCI Bridge Driver	4-4
4.4 Installing Audio Driver	4-6

4.5 Installing VGA Driver.....	4-8
4.6 Installing Ethernet Driver.....	4-10
4.7 Ethernet Software Configuration.....	4-11

Appendix A Programming The Watchdog Timer

A.1 Programming the Watchdog Timer.....	A-2
---	-----

Appendix B I/O Information

B.1 I/O Address Map.....	B-2
B.2 1 st MB Memory Address Map.....	B-3
B.3 IRQ Mapping Chart.....	B-4
B.4 DMA Channel Assignments.....	B-4

Chapter

1

**General
Information**

1.1 Introduction

The PCM-4896 is an all-in-one multi-media AMD Geode GX1 MMX processor based single board computer (SBC) with an integrated audio controller, a PCI Flat Panel controller, a PCI 10/100Base-Tx Ethernet interface, and one PCI expansion slot. With true Pentium MMX capability, the PCM-4896 achieves outstanding performance that surpasses other SBC in its class. In addition, the onboard SSD interface supports M-systems DiskOnChip 2000 series, memory capacity from 4MB to 288MB. This compact (only 5.75" x 8") unit offers all the functions of a single board industrial computer, but still fits in the space of a CD-ROM drive.

On-board features include four serial ports (three RS-232, one RS-232/422/485), one multi-mode parallel (ECP/EPP/SPP) port, connector for two USB (Universal Serial Bus) ports, a floppy drive controller, and a keyboard/PS/2 mouse interface. The built-in high speed PCI IDE controller supports Ultra DMA/33 mode. Up to two IDE devices can be connected, including large hard disks, CD-ROM drives, and tape backup drives, etc.

The PCM-4896 also features power management to minimize power consumption. It complies with the APM standard and supports three types of power saving features: Doze mode, Standby mode, and Suspend mode. In addition, the board's watchdog timer can be programmed to reset the system or generate an interrupt in case the system stops due to a program bug or

EMI.

Highly integrated multi-media SBC

The PCM-4896 is a highly integrated multi-media SBC that combines audio, video, and network functions on a CD-ROM drive size single computer board. PCM-4896 adopts PCI technology to achieve outstanding computing performance.

1.2 Features

- AMD Geode GX1 300MHz CPU onboard
- Support 24-bit TFT/DSTN Panel
- 1 x DIMM slot, Total up to 256MB
- Support Mini PCI Socket
- Support DiskOnChip and CompactFlash™
- Digital IO (4 in, 4 out)

1.3 Specifications

System

- CPU AMD Geode GX1 300MHz
- Memory 1 x SDRAM DIMM support up to 256MB
- Chipset AMD CS5530A
- I/O Chipset NS NS97317 / Winbond W83977EF
- Ethernet Realtek RTL 8100BL 10/100Mb Chip, RJ-45 x 1
- VGA / LCD Controller SMI SM 712, 4MB
Support dual view / simultaneous display on CRT + LCD
Support 24-bit TTL TFT panel
- BIOS Award Plug & Play BIOS – 256KB ROM
- IDE Interface P-ATA-33 x 1 channel (Support two ATAPI devices)
- Floppy Drive Interface Standard FDD port x 1, Floppy device x 2
- Four Serial Port Four COM ports:
- Digital IO 4 sets Digital IO (4 in, 4 out)
- Parallel Port Supports SPP / EPP / ECP mode
- Keyboard & Mouse One PS/2 Keyboard and Mouse

Connector

- Universal Serial Bus Total two USB 1.1 Port
- Watchdog Timer Generate a Time-out System Reset
- H/W Status Monitoring Supports Power Supply Voltage and Temperature Monitoring
- SSD Type II CompactFlash™ slot x 1, DOC x 1
- Expansion Interface Mini PCI Socket x 1, PC/104 x 1, PCI slot x 1
- Audio AD1819B 2CH AC97 CODEC, MIC-In / Line-In / Line-Out / CD-In, Stereo Amplified included
- Battery Lithium battery
- Power Supply Voltage 5V. AT/ATX
- Board Size 8" (L) x 5.75" (W)
(203mm x 146mm)
- Gross Weight 1.21b (0.5kg)
- Operating Temperature 32°F ~ 140°F (0°C~60°C)

Flat Panel/CRT Interface

- Chipset SM 712
- Display Memory: Built-in 4MB SDRAM
- Display Type: Supports non-interlaced CRT and LCD 24-bit TFT/displays. Can display both CRT and Flat Panel

- Resolution: simultaneously or Dual view
Up to 1027 x 768 for CRT
Up to 1024 x 768 for Flat Panel

Sound Interface

- Chipset: NS CS5530A

Ethernet Interface

- Chipset: Realtek RTL8100 100Base-Tx Fast Ethernet controller
- Ethernet Interface: 100Base-Tx RJ-45 connector.

SSD Interface

- One 32-pin DIP socket supports M-systems DiskOnChip up to 288 MB

Expansion Slots

- PC/104 connector: One 16-bit 104-pin connector Onboard
- PCI slot: One 32-bit PCI slot onboard
- Mini PCI

Mechanical and Environmental

- Power supply voltage: +5V (4.75V to 5.25V)
+12V (11.4V to 12.6V)

- Operating Temperature: 32 to 140°F (0 to 60°C)
- Board Size: 8" (L) x 5.75" (W) (203mm x 146mm)
- Weight: 1.2 lb. (0.5Kg)

Chapter

2

Quick Installation Guide

Notice:

The Quick Installation Guide is derived from Chapter 2 of user manual. For other chapters and further installation instructions, please refer to the user manual CD-ROM that came with the product.



2.1 Safety Precautions

Warning!

Always completely disconnect the power cord from your board whenever you are working on it. Do not make connections while the power is on, because a sudden rush of power can damage sensitive electronic components.

Caution!

Always ground yourself to remove any static charge before touching the board. Modern electronic devices are very sensitive to static electric charges. Use a grounding wrist strap at all times. Place all electronic components on a static-dissipative surface or in a static-shielded bag when they are not in the chassis

2.2 Location of Connectors and Jumpers

PCM-4896

Component Side

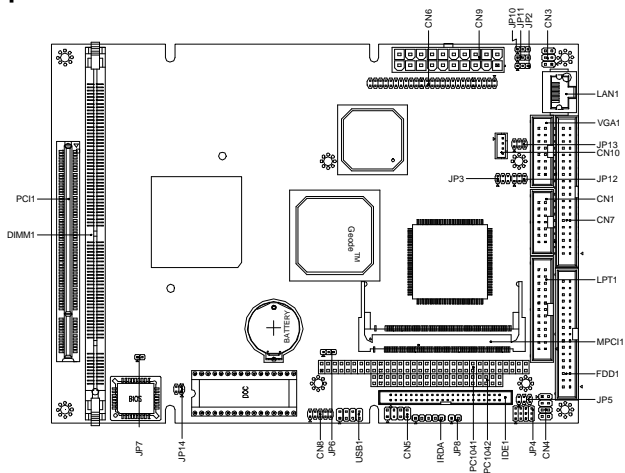

Solder Side

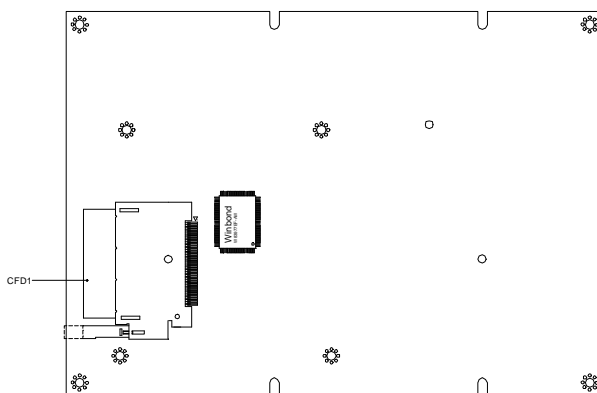

2.3 Mechanical Drawing

PCM-4896

Component Side

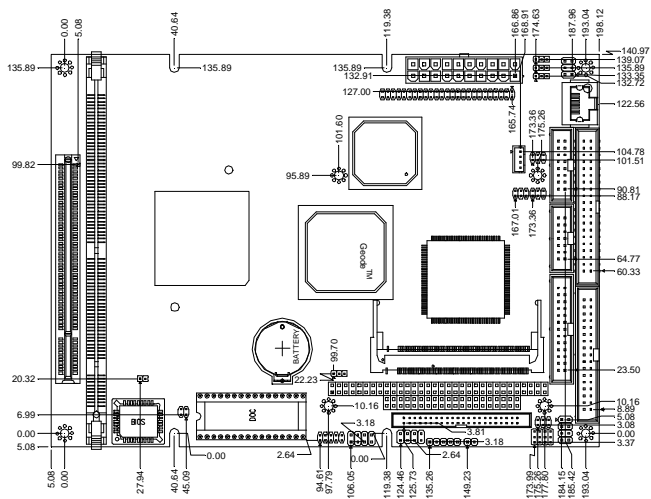

Solder Side

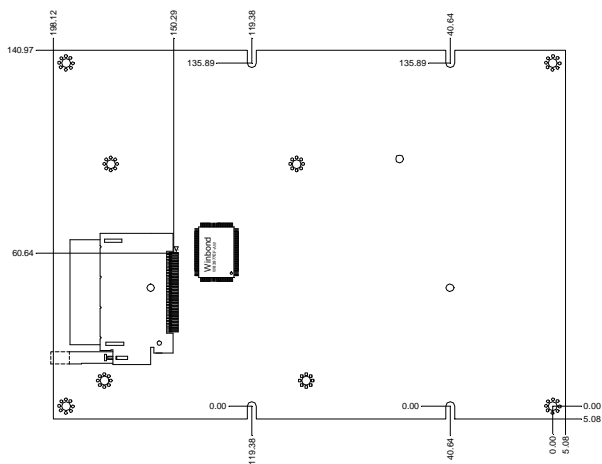

2.4 List of Jumpers

The board has a number of jumpers that allow you to configure your system to suit your application.

The table below shows the function of each of the board's jumpers:

Jumpers

Label	Function
JP2	Audio Power (default: 1-2 close)
JP3	Audio output select
JP4	COM2 RS232/422/485 setting
JP5	COM2 RS232/422/485 selection
JP6	Setup CMOS
JP7	Internal buzzer select
JP8	ATX soft-power switch connector
JP10	LCD driving voltage select
JP11	LCD clock select
JP12	COM3 RI pin voltage select
JP13	COM4 RI pin voltage select
JP14	DOC address select

2.5 List of Connectors

The board has a number of connectors that allow you to configure your system to suit your application. The table below shows the function of each board's connectors:

Connectors

Label	Function
CN1	Audio connector
CN2	IrDA connector
CN3	Ethernet Tx/Rx/Link LED connector
CN4	Keyboard and PS/2 mouse connector
CN5	Front panel connector
CN6	LCD display connector
CN7	Serial ports connector
CN8	Digital I/O connector
CN9	ATX power connector
CFD	CompactFlash Slot
FDD1	Floppy drive connector
IDE1	IDE drive connector
CN10	CD-ROM signal input connector
LAN1	100Base-Tx Ethernet connector
LPT1	Printer port connector
MPCI1	MINIPCI Slot
P104-1 & P104-2	PC/104 connector

U40	DiskOnChip socket
USB1	USB ports connector
VGA1	VGA display connector

2.6 Setting Jumpers

You configure your card to match the needs of your application by setting jumpers. A jumper is the simplest kind of electric switch. It consists of two metal pins and a small metal clip (often protected by a plastic cover) that slides over the pins to connect them. To “close” a jumper you connect the pins with the clip.

To “open” a jumper you remove the clip. Sometimes a jumper will have three pins, labeled 1, 2 and 3. In this case you would connect either pins 1 and 2 or 2 and 3.

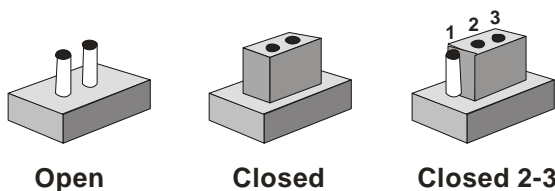

A pair of needle-nose pliers may be helpful when working with jumpers.

If you have any doubts about the best hardware configuration for your application, contact your local distributor or sales representative before you make any change.

Generally, you simply need a standard cable to make most connections.

2.7 Audio Power Setting (JP2)

JP2	Function
1-2	VCC5 (Default)
2-3	Reserved

2.8 Audio Output Selection (JP3)

JP3	Function
1-3, 2-4	Line out
3-5, 4-6	Speak out (Default)

2.9 COM 2 RS-232/422/485 Selection (JP3)

JP4	Function
1-2, 4-5, 7-8, 10-11	RS-232 (Default)
2-3, 5-6, 8-9, 11-12	RS-422
2-3, 5-6, 8-9, 11-12	RS-485

JP5	Function
1-2	RS-232 (Default)
3-4	RS-422
5-6	RS-485

2.10 Setup CMOS (JP6)

J6	Function
1-2	Normal (Default)
2-3	Clear CMOS

2.11 Internal Buzzer Selection (JP7)

JP7	Function
1-2	Internal Buzzer (Default)
Open	External Speaker

2.12 ATX Soft-Power Switch Connector (JP8)

The ATX Soft-Power switch connector is a 2-pin header. Please plug the power switch cable from your system to the Soft-Power switch connector marked JP8.

2.13 LCD Driving Voltage Selection (JP10)

JP10	Function
1-2	5V
2-3	3.3V (Default)

2.14 LCD Clock Signal Selection (JP11)

JP11	Function
2-3	SHF CLK (Default)
1-2	ASHF CLK

2.15 COM 3 / COM 4 RI Pin Voltage Selection (JP12, JP13)

COM3 RI Pin Setting (JP12)

JP12	Function
5-6	RI (Default)
3-4	+5V

1-2 +12V

COM4 RI Pin Setting (JP13)

JP13	Function
5-6	RI (Default)
3-4	+5V
1-2	+12V

2.16 DOC Address Selection (JP14)

The DiskOnChip 2000 occupies an 8K byte window in the upper memory address range of D400 to E000. You should ensure this does not conflict with any other device's memory address.

The configurations are as follows:

Address \ JP14	1-2	3-4
	Disable	ON
D400 (Default)	OFF	OFF
D800	ON	OFF
DC00	OFF	ON

These addresses might conflict with the ROM BIOS of other peripheral boards. Please select the appropriate memory address to avoid memory conflicts.

2.17 Audio Connector (CN1)

Pin	Signal	Pin	Signal
1	Mic In	2	Reserve for future use
3	GND	4	Reserve for future use

5	Line In Left	6	Reserve for future use
7	Line In Right	8	Reserve for future use
9	GND	10	Reserve for future use
11	Audio Out Left	12	Audio Out Right
13	GND_Line out	14	GND_Speaker out

CAUTION: Both Line-out and Speaker-out modes share the same pair of Audio Out signal lines but different grounds. In addition to setting up J6 on page 18, make sure you use the corresponding ground signal when making the cable by yourself.

2.18 IrDA Connector (CN2)

Pin	Signal
1	VCC5
2	NC
3	IrRx
4	GND
5	IrTx

2.19 Ethernet LED Signal Connectors (CN3)

Ethernet Active Signal LED

Flashing Tx or Rx LEDs indicate that the PCM-4896 is transmitting or receiving data.

Ethernet Link Signal LED

A continuously lit LED indicates good linkage between the PCM-4896 and its supporting hub.

Pin	Signal
1	Rx LED
2	+5 V
3	Link LED
4	+5 V
5	Tx LED
6	+5 V

2.20 Keyboard and Mouse Connector (CN4)

Pin	Signal	Pin	Signal
1	KB DATA	5	KB CLOCK
2	GND	6	VCC5
3	Mouse DATA	7	Mouse CLOCK
4	N/C	8	N/C

2.21 Front Panel Connector (CN5)

Pin	Signal	Pin	Signal
7	Reset – (GND)	8	Reset Switch
5	GND	6	NC
3	Speaker -	4	VCC
1	HDD LED -	2	VCC

2.22 Display Connectors (VGA1, CN6)

VGA Display Connector (VGA1)

Pin	Signal	Pin	Signal
1	RED	9	VCC +5V
2	GREEN	10	GND
3	BLUE	11	N/C
4	N/C	12	DDC DAT
5	GND	13	H-SYNC
6	GND	14	V-SYNC
7	GND	15	DDC CLK
8	GND	16	N/C

LCD Connector (CN6)

PCM-4896

Pin	Signal	Pin	Signal
1	+12 V _{DC}	2	+12 V _{DC}
3	GND	4	GND
5	+5 V _{DC} OR +3.3 V _{DC}	6	+5 V _{DC} OR +3.3 V _{DC}

7	VBIASEN	8	GND
9	P0	10	P1
11	P2	12	P3
13	P4	14	P5
15	P6	16	P7
17	P8	18	P9
19	P10	20	P11
21	P12	22	P13
23	P14	24	P15
25	P16	26	P17
27	P18	28	P19
29	P20	30	P21
31	P22	32	P23
33	P24	34	P25
35	SHF CLK	36	FLM (V SYS)
37	M	38	LP (H SYS)
39	GND	40	FPEN
41	P26	42	P27
43	P28	44	P29
45	P30	46	P31
47	P32	48	P33
49	P34	50	P35

2.23 Serial Ports (CN7)

The PCM-4896 offers four serial ports, three RS-232 and one RS-232/422/485. These ports allow you to connect them to serial devices (mouse, printers, etc.).

COM1 RS-232/422/485 Serial Ports (CN7)

Pin	Signal	Pin	Signal
1	DCDA	2	DSRA
3	RXDA	4	RTSA
5	TXDA	6	CTSA
7	DTRA	8	RIA
9	GND	10	N.C.

COM2 RS-232/422/485 Serial Ports (CN7)

Pin	Signal	Pin	Signal
11	DCDB (422TXD-/485DATA-)	12	DSRB
13	RXDB (422RXD+)	14	RTSB
15	TXDB (422TXD+/485DATA+)	16	CTSB
17	DTRB (422RXD-)	18	RIB
19	GND	20	N.C.

COM3 RS-232/422/485 Serial Ports (CN7)

Pin	Signal	Pin	Signal
21	DCDC	22	DSRC
23	RXDC	24	RTSC
25	TXDC	26	CTSC
27	DTRC	28	RIC/+5V/+12V
29	GND	30	N.C.

COM4 RS-232/422/485 Serial Ports (CN7)

Pin	Signal	Pin	Signal
31	DCDD	32	RSRD
33	RXDD	34	RTSD
35	TXDD	36	CTSD
37	DTRD	38	RID/+5V/+12V
39	GND	40	N.C.

2.24 Digital I/O Connector (CN8)

Pin	Signal	Pin	Signal
1	DI 0	2	DI 1
3	DI 2	4	DI 3
5	DO 0	6	DO 1
7	DO 2	8	DO 3
9	VCC	10	GND

2.25 ATX Power Connectors (CN9)

Pin	Signal	Pin	Signal
1	N/C	11	N/C
2	N/C	12	-12V
3	GND	13	GND
4	+5V	14	PON
5	GND	15	GND
6	+5V	16	GND
7	GND	17	GND
8	N/C	18	-5V
9	5V SB	19	+5V
10	+12V	20	+5V

2.26 CD Audio Connector (CN10)

Pin	Signal
1	GND
2	CD_L
3	GND
4	CD_R

2.27 Floppy Drive Connector (FDD1)

Pin	Signal	Pin	Signal
1	GND	2	DENSITY SELECT
3	GND	4	N/C
5	GND	6	DRIVE TYPE
7	GND	8	INDEX
9	GND	10	MOTOR 0
11	GND	12	DRIVE SELECT 1
13	GND	14	DRIVE SELECT 2
15	GND	16	MOTOR 1
17	GND	18	DIRECTION
19	GND	20	STEP
21	GND	22	WRITE DATA
23	GND	24	WRITE GATE
25	GND	26	TRACK 0
27	GND	28	WRITE PROTECT
29	GND	30	READ DATA
31	GND	32	HEAD DELECT
33	GND	34	DISK CHANGE

2.28 IDE Hard Drive Connector (IDE1)

Pin	Signal	Pin	Signal
1	IDE RESET	2	GND
3	DATA 7	4	DATA 8
5	DATA 6	6	DATA 9
7	DATA 5	8	DATA 10
9	DATA 4	10	DATA 11
11	DATA 3	12	DATA 12
13	DATA 2	14	DATA 13
15	DATA 1	16	DATA 14
17	DATA 0	18	DATA 15
19	SIGNAL GND	20	N/C
21	HDRQ	22	GND
23	IO WRITE	24	GND
25	IO READ	26	GND
27	IO CHANNEL READY	28	GND
29	HACK	30	GND
31	IRQ 14	32	N/C
33	ADDR 1	34	N/C
35	ADDR 0	36	ADDR 2
37	HARD DISK SELECT 0	38	HARD DISK SELECT 1
39	HD LED	40	GND
41	VCC	42	VCC
43	GND	44	N/C

2.29 100Base-Tx Ethernet Connector (LAN1)

Pin	Signal	Pin	Signal
1	Tx+	2	Tx-
3	Rx+	4	N/C
5	N/C	6	Rx-
7	N/C	8	N/C

2.30 Parallel Port Connector (LPT1)

Pin	Signal	Pin	Signal
1	STROBE	2	AUTOFD
3	D0	4	ERR
5	D1	6	INIT
7	D2	8	SLCTINI
9	D3	10	GND
11	D4	12	GND
13	D5	14	GND
15	D6	16	GND
17	D7	18	GND
19	ACK	20	GND
21	BUST	22	GND
23	PE	24	GND
25	SLCT	26	N/C

2.31 USB Connector (USB1)

Pin	Signal	Pin	Signal
1	GND	5	Vcc
2	USBD1+	6	USBD0-
3	USBD1-	7	USBD0+
4	Vcc	8	GND

2.32 DiskOnChip Socket (U40)

The DiskOnChip 2000 family of products provides a single chip solid-state flash disk in a standard 32-pin DIP package. The DiskOnChip 2000 is a solid-state disk with no moving parts, resulting in a significant reduction in power consumption and an increase in reliability. The DiskOnChip is a small plug and play Flash disk. It is easy to use and saves integration overhead.

The DiskOnChip 2000 family of products is available in capacities ranging from 2MB to 288MB, unformatted. In order to manage the disk, the DiskOnChip 2000 includes the TrueFFS, M-Systems Flash File System proprietary software. The DiskOnChip 2000 package is pin-to-pin compatible with a standard 32-pin EPROM device.

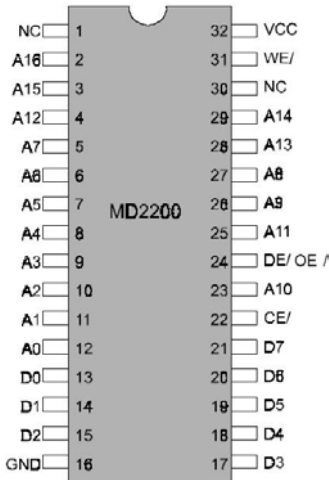

pin Name	Description	Pin Number	Direction	Note
A0-A12	Address bus	4-12,23,25-27	Inputs	
A13-A16	Address bus	2,3,28,29	Inputs	1
D0-D7	Data bus	13-15,17-21	I/O	
CE/	Chip Enable	22	Input	
OE/	Output Enable	24	Input	
WE/	Write Enable	31	Input	
NC	Not connected	1,30		2
VCC	Power	32		
GND	Ground	16		

Note 1: Pins A13 through A16 are not used by the MD2200. They are kept for socket backward compatibility with ED 1100 (DiskOnChip 1000)

Note 2: Pins 1 and 30 are not used by MD2200

2.33 DiskOnChip (DOC) 2000 Installation

When the DOC is installed correctly, a DOC will work like an HDD or an FDD.

To install the DOC on the main board, follow the instructions below:

1. Plug the DOC into the socket and make sure pin 1 of the DOC is aligned with pin 1 of the socket.
2. Push the DOC into the socket until it is firmly seated in the socket.

Caution: the DOC may be permanently damage if it is installed incorrectly.

3. Set the jumper for the memory address of the DOC.

Note:

The memory shadow function sometimes will create conflicts with the memory window. You should disable the memory shadow from the BIOS SETUP if the DOC cannot be accessed.

Configure DOC as a Boot Device

To configure a DOC as a boot drive, you should copy the operating system files onto the DOC. The following procedure is an example of the initialization process.

1. Install a DOC into your system.
2. Insert a bootable floppy disk in drive A: and boot the system.
3. At the DOS prompt, type SYS C: to transfer the DOS system files to the DOC (assuming the DiskOnChip is installed as drive C:). Reboot the system.
4. Go to the BIOS Setup Utility by hitting the key. Set the type of Primary Master or C: Drive as *Not Installed*.
5. Remove the floppy disk from the drive A: and leave the BIOS Setup Utility. The system should boot from the DOC.

Chapter

3

**Award
BIOS Setup**

3.1 System Test and Initialization

These routines test and initialize board hardware. If the routines encounter an error during the tests, you will either hear a few short beeps or see an error message on the screen. There are two kinds of errors: fatal and non-fatal. The system can usually continue the boot up sequence with non-fatal errors. Non-fatal error messages usually appear on the screen along with the following instructions:

Press <F1> to RESUME

Write down the message and press the F1 key to continue the boot up sequence.

System configuration verification

These routines check the current system configuration against the values stored in the CMOS memory. If they do not match, the program outputs an error message. You will then need to run the BIOS setup program to set the configuration information in memory.

There are three situations in which you will need to change the CMOS settings:

1. You are starting your system for the first time
2. You have changed the hardware attached to your system
3. The CMOS memory has lost power and the configuration information has been erased.

The PCM-4896 CMOS memory has an integral lithium battery backup for data retention. However, you will need to replace the complete unit when it finally runs down.

3.2 Award BIOS Setup

Awards BIOS ROM has a built-in Setup program that allows users to modify the basic system configuration. This type of information is stored in battery-backed CMOS RAM so that it retains the Setup information when the power is turned off.

Entering Setup

Power on the computer and press immediately. This will allow you to enter Setup.

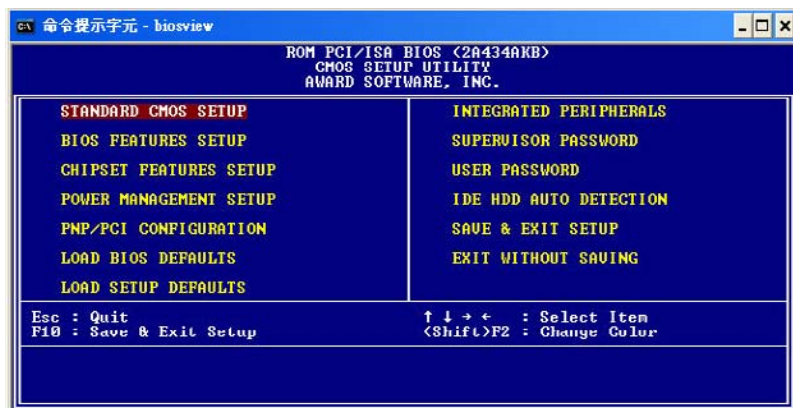

Standard CMOS Features

Use this menu for basic system configuration. (Date, time, IDE, etc.)

BIOS Features Setup

Use this menu to set the advanced features available on your system.

Chipset Features Setup

Use this menu to change the values in the chipset registers and optimize your system performance.

Power Management Setup

Use this menu to specify your settings for power management. (HDD power down, power on by ring, KB wake up, etc.)

PnP/PCI Configurations

This entry appears if your system supports PnP/PCI.

Load BIOS Defaults

Use this menu to load the BIOS default values for the minimal/stable performance for your system to operate.

Load Setup Defaults

Use this menu to load the BIOS default values that are factory settings for optimal performance system operations. While AWARD has designated the custom BIOS to maximize performance, the factory has the right to change these defaults to meet their needs.

Integrated Peripherals

Use this menu to specify your settings for integrated peripherals. (Primary slave, secondary slave, keyboard, mouse etc.)

Set Supervisor/User Password

Use this menu to set Supervisor/User Passwords.

Save and Exit Setup

Save CMOS value changes to CMOS and exit setup.

Exit Without Saving

Abandon all CMOS value changes and exit setup.

You can refer to the "AAEON BIOS Item Description.pdf" file in the CD for the meaning of each setting in this chapter.

Chapter

4

**Driver
Installation**

4.1 Software Drivers

This chapter describes the operation and installation of the display drivers supplied on the Supporting CD-ROM that are shipped with your product. The onboard VGA adapter is based on the CS5530A VGA Flat Panel/CRT controller. This controller offers a large set of extended functions and higher resolutions. If you intend to use your VGA adapter in standard VGA modes only, you do not need to install any of these drivers. Since your VGA adapter is fully compatible, it does not require any special drivers to operate in standard modes.

The purpose of the enclosed software drivers is to take advantage of the extended features of the CS5530A VGA Flat Panel/CRT controller.

Hardware Configuration

Some of the high-resolution drivers provided in this package will work only in certain system configurations. If a driver does not display correctly, try the following:

1. Change the display controller to CRT-only mode, rather than flat panel or simultaneous display mode. Some high-resolution drivers will display correctly only in CRT mode.
2. If a high-resolution mode is not supported on your system, try using a lower-resolution mode. For example, 1024 x 768 mode will not work on some systems, but 800 x 600 mode is supported on most.

4.2 Necessary to Know

The instructions in this manual assume that you understand elementary concepts of MS-DOS and the IBM Personal Computer. Before you attempt to install any driver from the *Supporting CD-ROM*, you should:

- Know how to copy files from a CD-ROM to a directory on the hard disk
- Understand the MS-DOS directory structure

If you are uncertain about any of these concepts, please refer to the DOS or OS/2 user reference guides for more information before you proceed with the installation.

Before you begin

The Supporting CD-ROM contains different drivers for corresponding Windows OS, please choose the specific driver for your Windows OS.

4.3 Installing GX1 / CS 5530 PCI Bridge Driver

Win 98 System

Simply, install the provided CD into the CD-ROM drive and select, **my computer**. Click on the CD-ROM drive in the open window. Find the file named **Cyrix MediaGX Certified Win9x Drivers 4.0.exe** (path: Driver/System/Win98), and double click on the file. The file will open up and offer a **set up wizard**. Follow the instructions and click on the corresponding buttons and the PCI bridge and the system devices will self install. You should shutdown afterwards to ensure proper installation.

Win 2000 System

Place the Driver CD-ROM into your CD-ROM drive and pull up the CD-ROM file on your screen.

1. Click on **Start** button.
2. Click on **Settings** button.
3. Click on **Control Panel** button.
4. Click on **System** button.
5. Select **Hardware** and click on **Device Manager...**
6. Double click on **Other PCI Bridge Device**
7. Click on **Reinstall Driver...**
8. Click on **Next**.
9. Select **Search for a suitable driver...**, then click on **Next**.
10. Select **Specify a location**, then click on **Next**.
11. Click on **Browse**.

12. Select **NSC.inf** from CD-ROM (**Driver/System/Win2000**) then click on **open**.
13. Click on **OK**.
14. Click on **Next**.
15. Click on **Finish**.

4.4 Installing Audio Driver

Win 98 System

Simply, install the provided CD into the CD-ROM drive and select, **my computer**. Click on the CD-ROM drive in the open window. Find the file named **Cyrix MediaGX Certified Win9x Drivers 4.0.exe** (path: Driver/System/Win98), and double click on the file. The file will open up and offer a **set up wizard**. Follow the instructions and click on the corresponding buttons and the PCI bridge and the system devices will self install. You should shutdown afterwards to ensure proper installation.

Win 2000 Audio

Place the Driver CD-ROM into your CD-ROM drive and pull up the CD-ROM file on your screen.

1. Click on **Start** button.
2. Click on **Settings** button.
3. Click on **Control Panel** button.
4. Click on **System** button.
5. Select **Hardware** and click on **Device Manager...**
6. Double click on **Multimedia Audio Controller**.
7. Click on **Reinstall Driver...**
8. Click on **Next**.
9. Select **Search for a suitable driver...**, then click on **Next**.
10. Select **Specify a location**, then click on **Next**.
11. Click on **Browse**.
12. Select **GXWDMXA.INF** from CD-ROM (**Driver/Audio/Win2000**)

then click on **Open**.

13. Click on **OK**.

14. Click on **Next**.

15. Click on **Yes**.

16. Click on **Finish**.

4.5 Installing VGA Driver

Win 98 VGA

Place the Driver CD-ROM into your CD-ROM drive and pull up the CD-ROM file on your screen.

1. Click on **Start** button.
2. Click on **Settings** button.
3. Click on **Control Panel** button.
4. Click on **System** button.
5. Select **Hardware** and click on **Device Manager...**
6. Double click on **Video Controller (VGA Compatible)**.
7. Click on **Reinstall Driver....**
8. Click on **Next**.
9. Select **Search for a suitable driver...**, then click on **Next**.
10. Select **Specify a location**, then click on **Next**.
11. Click on **Browse**.
12. Select **SMI.INF** from CD-ROM (**Driver/VGA/Win2000**) then click on **Open**.
13. Click on **OK**.
14. Click on **Next**.
15. Click on **Yes**.
16. Click on **Finish**.

Win 2000 VGA

Place the Driver CD-ROM into your CD-ROM drive and pull up the CD-ROM file on your screen.

1. Click on **Start** button.
2. Click on **Settings** button.
3. Click on **Control Panel** button.
4. Click on **System** button.
5. Select **Hardware** and click on **Device Manager...**
6. Double click on **Video Controller (VGA Compatible)**.
7. Click on **Reinstall Driver...**
8. Click on **Next**.
9. Select **Search for a suitable driver...**, then click on **Next**.
10. Select **Specify a location**, then click on **Next**.
11. Click on **Browse**.
12. Select **SMISETUP.INF** from CD-ROM (**Driver/VGA/Win2000**)
then click on **Open**.
13. Click on **OK**.
14. Click on **Next**.
15. Click on **Yes**.
16. Click on **Finish**.

4.6 Installing Ethernet Driver

Win 98 Ethernet

Win 2000 Ethernet

Simply, install the provided CD into the CD-ROM drive and select, **my computer**. Click on the CD-ROM drive in the open window. Find the file named **Setup.exe** (path: Driver/System/Win98),

4.7 Ethernet Software Configuration

The onboard Ethernet interface supports all major network operating systems. I/O addresses and interrupts are easily configured via the Insyde BIOS Setup. To configure the medium type, to view the current configuration, or to run diagnostics, please refer to the following instruction:

1. Power the main board on. Ensure that the RSET8139.EXE file is located in the working drive.
2. At the prompt, type RSET8139.EXE and press <ENTER>. The Ethernet configuration program will then be displayed.
3. This simple screen shows all the available options for the Ethernet interface. Just highlight the option you wish to change by using the Up and DOWN keys. To change a selected item, press <ENTER>, and a screen will appear with the available options. Highlight your option and press <ENTER>. Each highlighted option has a helpful message guide displayed at the bottom of the screen for additional information.
4. After you have made your selections and the configuration is what you want, press <ESC>. A prompt will appear asking if you want to save the configuration. Press "Y" if you want to save.

There are three very useful diagnostic functions offered in the Ethernet Setup Menu as follows:

1. Run EEPROM test

2. Run Diagnostics on Board
3. Run Diagnostics on Network

Each option has its own display screen, which shows the format and result of any diagnostic tests undertaken.

Appendix

A

Programming the Watchdog Timer

A.1 Programming the Watchdog Timer

How to program the WATCHDOG TIMER

1. To set the time-out interval of watchdog timer:

-- output the desired value to port **0x443(hexadecimal)**. Since the data is of 1 byte, the maximum value will be 255. In our design 2 ~ 255 will denote 2 ~ 255 sec.

outportb(0x443, 1E); // set watchdog to 30 seconds

2. To set the time-out event:

-- output data to **port 0x444**,

0: reset system

1, 2, 3: IRQ 10, 15, 11 respectively

4: NMI

e.g.

outportb(0x444, 0); // set time-out event to reset-system

3. To disable watchdog timer:

-- output value 0 to port 0x443

outportb(0x443, 0); // disable watchdog timer

4. To enable or refresh watchdog timer(the watchdog timer will return to its initial value, then count down):

-- access the I/O port 0x443, e.g.

outportb(0x443, data); // refresh watchdog timer

* note: if you want to refresh the watchdog timer, you have to disable it first.

Demo program

```
outportb(0x444, 0); // set time-out event to reset-system
outportb(0x443, 0A); // set time-out interval to 10 seconds
customer_job(); // execute your job here, be sure your
                // job will finished within 10 seconds
outportb(0x443, 0); // refresh watchdog timer, otherwise
                    // the system will reset after time-out
outportb(0x443, 14); // set time-out interval to 20 seconds
another_job(); // another job finished in 20 seconds
outportb(0x443, 0) // disable watchdog timer
...
...
```

Appendix

B

I/O Information

B.1 I/O Address Map

YA		
+	Direct memory access (DMA)	
+	Input/output (IO)	
	[00000000 - 0000000F]	Direct memory access controller
	[00000020 - 00000021]	Programmable interrupt controller
	[00000022 - 0000003F]	PCI bus
	[00000040 - 00000043]	System timer
	[00000044 - 00000047]	PCI bus
	[0000004C - 0000006F]	PCI bus
	[00000060 - 00000060]	PC/AT Enhanced PS/2 Keyboard (101/102-Key)
	[00000061 - 00000061]	System speaker
	[00000064 - 00000064]	PC/AT Enhanced PS/2 Keyboard (101/102-Key)
	[00000070 - 00000071]	system CMOS/real time clock
	[00000072 - 0000007F]	PCI bus
	[00000081 - 00000083]	Direct memory access controller
	[00000087 - 00000087]	Direct memory access controller
	[00000089 - 0000008B]	Direct memory access controller
	[0000008E - 00000091]	Direct memory access controller
	[00000090 - 00000091]	PCI bus
	[00000093 - 0000009F]	PCI bus
	[000000A0 - 000000A1]	Programmable interrupt controller
	[000000A2 - 000000BF]	PCI bus
	[000000C0 - 000000C7]	Direct memory access controller
	[000000E0 - 000000EF]	PCI bus
	[000000F0 - 000000FF]	Numeric data processor
	[00000100 - 00000CF7]	PCI bus
	[00000170 - 00000177]	Secondary IDE Channel
	[000001F0 - 000001F7]	Primary IDE Channel
	[00000200 - 00000200]	Standard Game Port
	[00000270 - 0000027F]	Cyrix XpressAI IDIO(TM) Driver (WDM)
	[00000274 - 00000277]	ISAPNP Read Data Port
	[00000279 - 00000279]	ISAPNP Read Data Port
	[000002E8 - 000002EF]	Communications Port (COM4)
	[000002F8 - 000002FF]	Communications Port (COM2)
	[00000330 - 00000331]	Cyrix XpressAUDIO(TM) Driver (WDM)
	[00000376 - 00000376]	Secondary IDE Channel
	[00000378 - 0000037F]	Printer Port (LPT1)
	[00000388 - 0000038B]	Cyrix XpressAUDIO(TM) Driver (WDM)
	[000003B0 - 000003BB]	Silicon Motion LynxEM+
	[000003C0 - 000003DF]	Silicon Motion LynxEM+
	[000003E8 - 000003EF]	Communications Port (COM3)
	[000003F2 - 000003F5]	Standard floppy disk controller
	[000003F6 - 000003F6]	Primary IDE Channel
	[000003F7 - 000003F7]	Standard floppy disk controller
	[000003F8 - 000003FF]	Communications Port (COM1)
	[00000800 - 00000809]	Motherboard resources
	[00000A79 - 00000A79]	ISAPNP Read Data Port
	[00000D00 - 0000FFFF]	PCI bus
	[0000AC80 - 0000AC9F]	Motherboard resources
	[0000E000 - 0000E0FF]	Realtek RTL8139(A) PCI Fast Ethernet Adapter
	[0000F000 - 0000F00F]	Standard Dual Channel PCI IDE Controller
+	Interrupt request (IRQ)	
+	Memory	

B.2 1st MB Memory Address Map

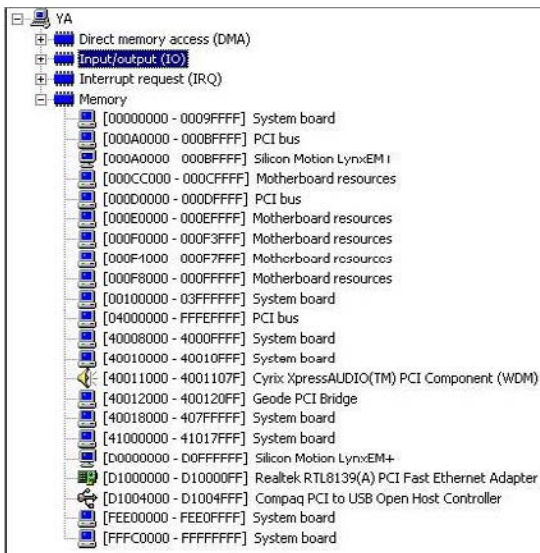

B.3 IRQ Mapping Chart

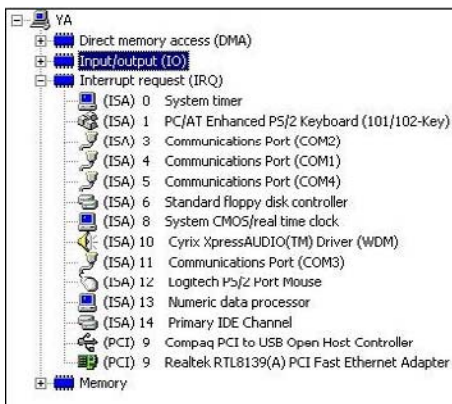

B.4 DMA Channel Assignments

