

Micro ATX Board

EMB-900M

EMB-900M

Intel® Pentium® 4 Processor,
Up to 3.6GHz
Micro ATX Board
With LCD and Ethernet,
7.1 Channel Audio & Mini PCI

EMB-900M Rev. A Manual 2nd Ed.
August 2005

Copyright Notice

This document is copyrighted, 2005. All rights are reserved. The original manufacturer reserves the right to make improvements to the products described in this manual at any time without notice.

No part of this manual may be reproduced, copied, translated, or transmitted in any form or by any means without the prior written permission of the original manufacturer. Information provided in this manual is intended to be accurate and reliable. However, the original manufacturer assumes no responsibility for its use, or for any infringements upon the rights of third parties that may result from its use.

The material in this document is for product information only and is subject to change without notice. While reasonable efforts have been made in the preparation of this document to assure its accuracy, AAEON assumes no liabilities resulting from errors or omissions in this document, or from the use of the information contained herein.

AAEON reserves the right to make changes in the product design without notice to its users.

Acknowledgments

All other products' name or trademarks are properties of their respective owners.

- Award is a trademark of Award Software International, Inc.
- CompactFlash™ is a trademark of the Compact Flash Association.
- Intel® Pentium® 4 / Celeron® D is trademark of Intel® Corporation.
- Microsoft Windows® is a registered trademark of Microsoft Corp.
- ITE is a trademark of Integrated Technology Express, Inc.
- IBM, PC/AT, PS/2, and VGA are trademarks of International Business Machines Corporation.
- SoundBlaster is a trademark of Creative Labs, Inc.

Packing List

Before you begin installing your card, please make sure that the following materials have been shipped:

- 1 EMB-900M CPU Card
- 1 Quick Installation Guide
- 1 CD-ROM for manual (in PDF format) and drivers
- 1 40 pin IDE Cable
- 1 34 pin FDD Cable
- 1 Serial Port Cable
- 3 SATA Cable
- 3 SATA Power Cable
- 2 USB Cable
- 1 DVI to CRT Converter (Only for Model with DVI)

If any of these items should be missing or damaged, please contact your distributor or sales representative immediately.

Optional Accessories

- 1700290150 DVI+VGA Y-Cable

Contents

Chapter 1 General Information

1.1 Introduction	1-2
1.2 Features.....	1-4
1.3 Specifications	1-5

Chapter 2 Quick Installation Guide

2.1 Safety Precautions	2-2
2.2 Location of Connectors and Jumpers	2-3
2.3 Mechanical Drawing	2-6
2.4 List of Jumpers	2-9
2.5 List of Connectors	2-10
2.6 Setting Jumpers.....	2-12
2.7 Audio Out Selection (JP1).....	2-13
2.8 LCD Voltage Selection (JP4).....	2-13
2.9 Clear CMOS (JP5).....	2-13
2.10 COM3 Ring / +5V / +12V Selection (JP6).....	2-13
2.11 COM4 Ring / +5V / +12V Selection (JP8).....	2-14
2.12 CD-IN Connector (CN1).....	2-14
2.13 ATX Power_12V Connector (CN2)	2-14
2.14 LVDS Connector (CN3).....	2-14
2.15 CPU Fan Connector (CN4)	2-15
2.16 USB Connector (CN5, CN16).....	2-15
2.17 Second Digital I/O Connector (CN6)	2-16

2.18 First Digital I/O Connector (CN7)..... 2-16
2.19 Fan Connector (CN10, CN13) 2-16
2.20 Front Panel Connector (CN11)..... 2-17
2.21 ATX-24 Power Connector (CN12) 2-17
2.22 RS-232/422/485 Serial Port Connector (CN14) 2-18
2.23 IrDA Connector (CN15)..... 2-19
2.24 Audio 7.1 Channel Connector..... 2-19

Chapter 3 Award BIOS Setup

3.1 System Test and Initialization 3-2
3.2 Award BIOS Setup 3-3

Chapter 4 Driver Installation

4.1 Step 1 – Install INF Driver 4-3
4.2 Step 2 – Install VGA Driver 4-3
4.3 Step 3 – Install LAN Driver..... 4-3
4.4 Step 4 – Install Audio Driver..... 4-3

Appendix A Programming The Watchdog Timer

A.1 Programming.....A-2
A.2 IT8712 Watchdog Timer Initial Program.....A-7

Appendix B I/O Information

B.1 I/O Address Map.....B-2
B.2 1st MB Memory Address Map..... B-3
B.3 IRQ Mapping Chart..... B-4
B.4 DMA Channel Assignments..... B-4

Chapter

1

**General
Information**

1.1 Introduction

The EMB-900M is AAEON's first board that supports Intel® 915GV Express chipset. This is important breakthroughs for AAEON® in the industrial environment domain.

High-Quality and Extreme Performance

With the flexibility to support the Intel® Pentium® 4 processor 550 with HT Technology and Intel® Celeron® D processor 340, the EMB-900M can offer a scalable solution across different processing speeds. The EMB-900M also provides an improved performance over previous solutions by incorporating the Intel® 915GV Express chipset. The DDR2 and PCI Express interface are the newest technologies that allow the EMB-900M to provide very high-speed bus bandwidth. By using PCI Express interface and adding 192KHz/7.1 Channel HD Audio, the EMB-900M can bring a significant increase in audio and visual performance in various applications. The extended life motherboards that AAEON supplies to the industrial markets offer functionality not available in off-the-shelf consumer motherboards, such as High-Bandwidth Gigabit Ethernet Connectivity, 4 COM Ports and optional ISA expansion slot.

Multimedia Function

The EMB-900M can be broadly implemented in various applications. It is suitable for High-end POS/ KIOSK by taking advantage of the Intel® Graphics Media Accelerator 900 (Intel® GMA 900). It is also suitable for Gigabit firewall and security applications thanks to its Gigabit-Ethernet

Controller that utilizes a PCI-Express interface. The applicability extends to Gaming and Entertainment Markets as well because of the 192K/24bit 7.1 Channel HD Audio via Intel® I/O Controller Hub 6.

1.2 Features

- Supports Intel® Pentium® 4/Celeron D(LGA775) Processor
Up to 3.6GHz
- Supports CRT, LVDS and DVI Display
- Two Gigabit Ethernet Ports Support Based Upon PCI
Express Bus
- Supports 7.1 Channel High Definition Audio
- Supports Type II CompactFlash™ Memory
- 2 PCI-E / 2 PCI / 1 Mini PCI / 1 Legacy ISA (Optional)
- 4 COM / 8 USB 2.0 / Digital I/O Ports

1.3 Specifications

System

- CPU: Supports Pentium® 4 LGA775 Processor, up to 3.6GHz
- Memory: Dual Channel DDR-II 400/533, Max. 4GB
- Chipset: Intel® 915GV + ICH6
- Ethernet: Dual Marvell 88E8053, 10/100/1000 Base-TX RJ-45
- BIOS: AWARD 512KB FLASH ROM
- Watchdog Timer: Generate a time-out system reset
- H/W Status Monitoring: Supports power supply voltages, fan speed and temperatures monitoring
- SSD: Type II CompactFlash™ slot x 1
- Expansion Interface: PCI slot x 2, PCI Express x 2, Mini PCI x 1, ISA(Optional) x 1
- Battery: Lithium battery
- Power Supply Voltage: +3.3V, $\pm 5V$, +5VSB, $\pm 12V$, ATX12V/ATX24P
- Board Size: 9.6"(L) x 9.6"(W) (244mm x 244mm)
- Gross Weight: 1.32 lb (0.6kg)
- Operating Temperature: 32 F~140 F (0 C~60 C)

Display

- Chipset: Intel® 915GV
- Memory: Shared memory up to 224MB with DVMT 3.0
- Resolutions: Up to 1600 x 1200
- Display Mode: Supports CRT/LCD, CRT/DVI, LCD/DVI simultaneous display
- LCD Interface: Up to 48-bit dual channel LVDS, DVI

I/O

- MIO: UDMA100 x 1, SATA x 3, Floppy Disk Drive x 1, PS/2 Keyboard x 1, PS/2 Mouse x 1, RS-232 x 3, RS-232/422/485 x 1, Parallel x 1
- IrDA: One IrDA Tx/Rx header
- Audio: MIC-in, Line-in, Line-out, CD-in, S/PDIF in/out, or 7.1 output
- USB: Two Type-A(dual) connectors support 4 USB 2.0 ports(External)
Two 5 x 2 pin header support 4 USB 2.0 ports(Internal)
- Digital I/O Supports up to 16 in and 16 out

Chapter

2

Quick Installation Guide

Notice:

The Quick Installation Guide is derived from Chapter 2 of user manual. For other chapters and further installation instructions, please refer to the user manual CD-ROM that came with the product.



2.1 Safety Precautions

Warning!

Always completely disconnect the power cord from your board whenever you are working on it. Do not make connections while the power is on, because a sudden rush of power can damage sensitive electronic components.

Caution!

Always ground yourself to remove any static charge before touching the board. Modern electronic devices are very sensitive to static electric charges. Use a grounding wrist strap at all times. Place all electronic components on a static-dissipative surface or in a static-shielded bag when they are not in the chassis

2.2 Location of Connectors and Jumpers

Component Side – For DVI Interface

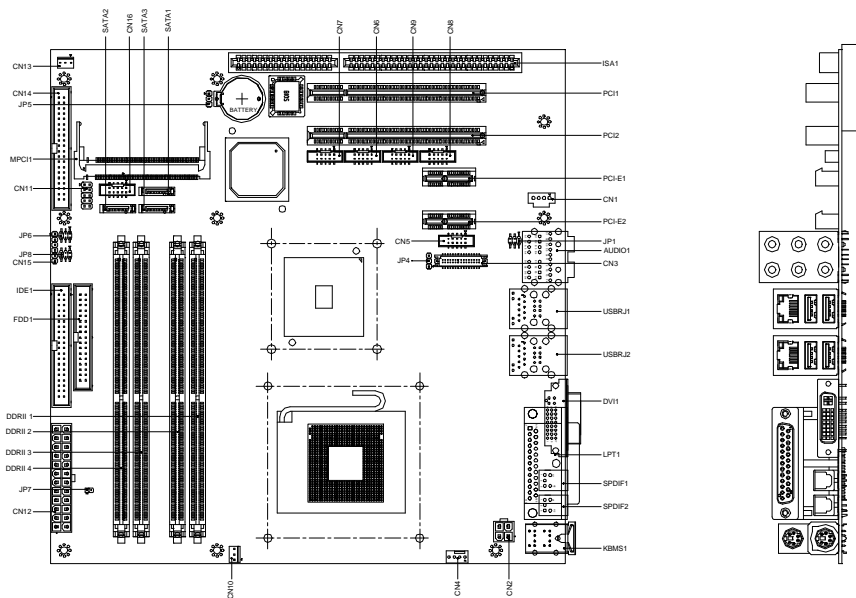

Component Side – For VGA Interface

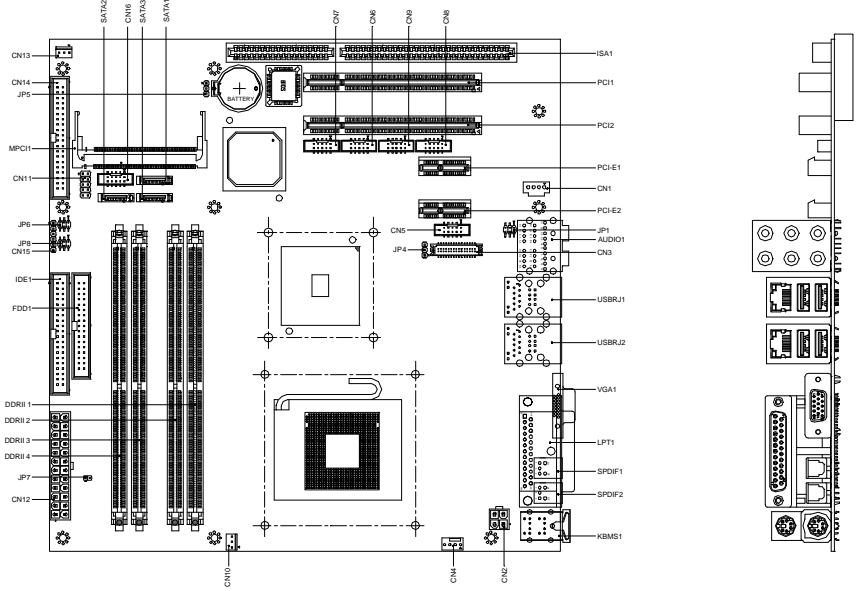

Solder Side

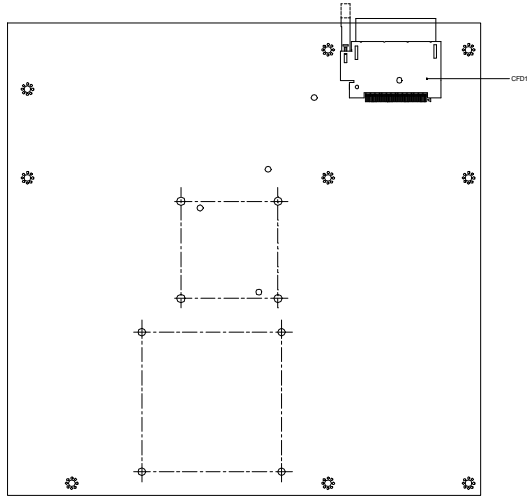

Component Side – For VGA Interface

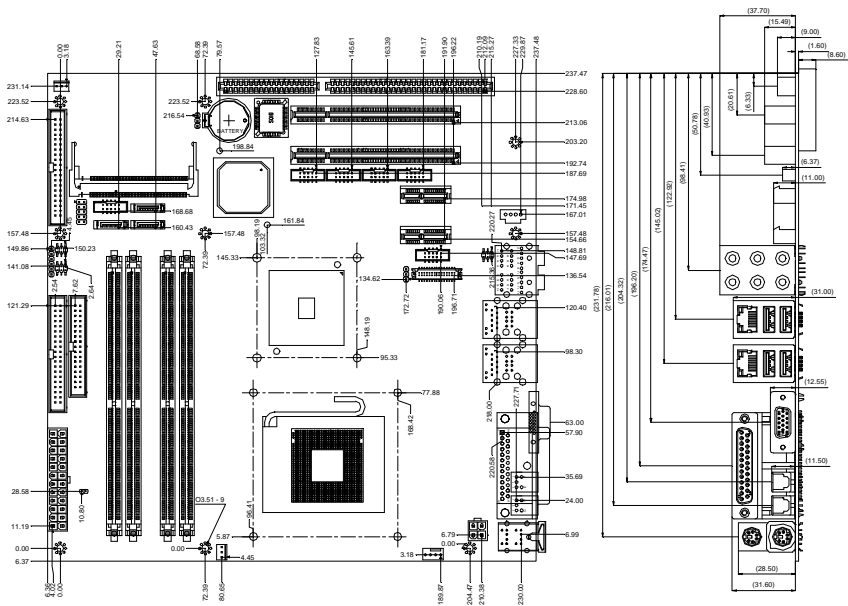

Solder Side

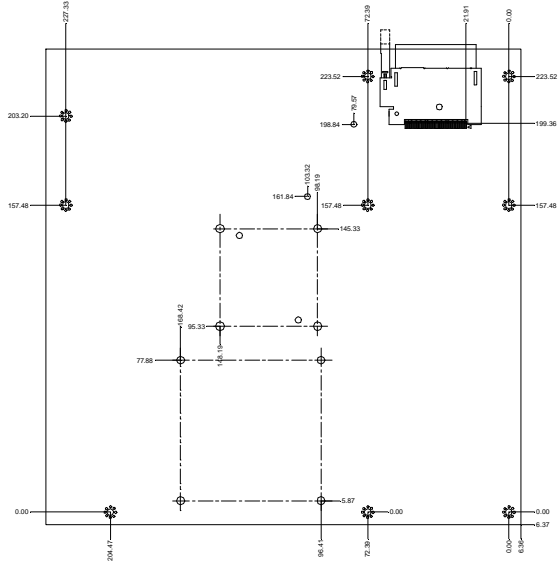

2.4 List of Jumpers

The board has a number of jumpers that allow you to configure your system to suit your application.

The table below shows the function of each of the board's jumpers:

Jumpers

Label	Function
JP1	Audio Out Selection
JP4	LCD Voltage Selection
JP5	Clear CMOS
JP6	COM 3 Ring / +5V/ +12V Selection
JP7	Reserve
JP8	COM 4 Ring / +5V/ +12V Selection

2.5 List of Connectors

The board has a number of connectors that allow you to configure your system to suit your application. The table below shows the function of each board's connectors:

Connectors

Label	Function
CN1	CD-IN Connector
CN2	ATX Power_12V Connector
CN3	LVDS Connector
CN4	CPU Fan Connector
CN5, CN16	USB Connector
CN6	Second Digital I/O Connector
CN7	First Digital I/O Connector
CN8	Reserve
CN9	Reserve
CN10, CN13	Fan Connector
CN11	Front Panel Connector
CN12	ATX Power Connector
CN14	RS-232/422/485 Serial Port Connector
CN15	IrDA Connector
FDD1	Floppy Connector
IDE1	EIDE Connector
VGA1	VGA Display Connector
LPT1	LPT Port Connector
USBRJ1, USBRJ2	USB & Lan Connector

Audio1	Audio 7.1 Channel Connector
DVI1	DVI Connector
PCI1,PCI2	PCI Slot
MPCI1	Mini PCI Slot
CFD1	CompactFlash™ Slot
DIMM1,2	Channel A DIMM Slot
DIMM3,4	Channel B DIMM Slot
ISA1	ISA Slot
PCI-E1,PCI-E2	PCI Express Slot
KBMS1	PS2 KB/MS Connector
SPDIF1	SPDIF In Connector
SPDIF2	SPDIF Out Connector
SATA1,2,3	SATA Connector

2.6 Setting Jumpers

You configure your card to match the needs of your application by setting jumpers. A jumper is the simplest kind of electric switch. It consists of two metal pins and a small metal clip (often protected by a plastic cover) that slides over the pins to connect them. To “close” a jumper you connect the pins with the clip.

To “open” a jumper you remove the clip. Sometimes a jumper will have three pins, labeled 1, 2 and 3. In this case you would connect either pins 1 and 2 or 2 and 3.

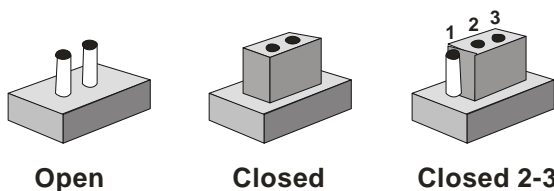

A pair of needle-nose pliers may be helpful when working with jumpers.

If you have any doubts about the best hardware configuration for your application, contact your local distributor or sales representative before you make any change.

Generally, you simply need a standard cable to make most connections.

2.7 Audio Out Selection (JP1)

JP1	Function
1-3, 2-4	W/O Amplifier
3-5, 4-6	W/ Amplifier (Default)

2.8 LCD Voltage Selection (JP4)

JP4	Function
1-2	+5V
2-3	+3.3V (Default)

2.9 Clear CMOS (JP5)

JP5	Function
1-2	Protected (Default)
2-3	Clear

2.10 COM3 Ring / +5V / +12V Selection (JP6)

JP6	Function
1-2	+12V
3-4	+5V
5-6	Ring (Default)

2.11 COM4 Ring / +5V / +12V Selection (JP8)

JP8	Function
1-2	+12V
3-4	+5V
5-6	Ring (Default)

2.12 CD-IN Connector (CN1)

Pin	Signal
1	CD IN L
2	GND
3	GND
4	CD_IN_R

2.13 ATX Power_12V Connector (CN2)

Pin	Signal
1	GND
2	GND
3	+12V
4	+12V

2.14 LVDS Connector (CN3)

Pin	Signal	Pin	Signal
1	ENBKL	2	N.C
3	PPVCC	4	GND
5	LVDS1_TXCLK-	6	LVDS1_TXCLK+
7	PPVCC	8	GND

Micro ATX Board**EMB-900M**

9	LVDS1_TX0-	10	LVDS1_TX0+
11	LVDS1_TX1-	12	LVDS1_TX1+
13	LVDS1_TX2-	14	LVDS1_TX2+
15	LVDS1_TX3-	16	LVDS1_TX3+
17	I2C_DATA	18	I2C_CLK
19	LVDS2_TX0-	20	LVDS2_TX0+
21	LVDS2_TX1-	22	LVDS2_TX1+
23	LVDS2_TX2-	24	LVDS2_TX2+
25	LVDS2_TX3-	26	LVDS2_TX3+
27	PPVCC	28	GND
29	LVDS2_TXCLK-	30	LVDS2_TXCLK+

2.15 CPU Fan Connector (CN4)

Pin	Signal
1	GND
2	+12V
3	Speed Sense
4	Speed Control

2.16 USB Connector (CN5, CN16)

Pin	Signal	Pin	Signal
1	+5V	2	GND
3	USBD1-	4	GND
5	USBD1+	6	USBD2+
7	GND	8	USBD2-
9	GND	10	+5V

2.17 Second Digital I/O Connector (CN6)

Pin	Signal	Pin	Signal
1	DIO2-1	2	DIO2-2
3	DIO2-3	4	DIO2-4
5	DIO2-5	6	DIO2-6
7	DIO2-7	8	DIO2-8
9	+5V	10	GND

Address=2F1H

2.18 First Digital I/O Connector (CN7)

Pin	Signal	Pin	Signal
1	DIO1-1	2	DIO1-2
3	DIO1-3	4	DIO1-4
5	DIO1-5	6	DIO1-6
7	DIO1-7	8	DIO1-8
9	+5V	10	GND

Address=2F0H

2.19 Fan Connector (CN10, CN13)

Pin	Signal
1	GND
2	+12V
3	Speed Sense

2.20 Front Panel Connector (CN11)

Pin	Signal	Pin	Signal
1	Power On Button(-)	2	Power On Button(+)
3	IDE LED(-)	4	IDE LED(+)
5	External Buzzer(-)	6	External Buzzer(+)
7	Power LED(-)	8	Power LED(+)
9	Reset Switch(-)	10	Reset Switch(+)

2.21 ATX-24 Power Connector (CN12)

Pin	Signal	Pin	Signal
1	N.C	13	N.C
2	N.C	14	-12V
3	GND	15	GND
4	+5V	16	PS_ON
5	GND	17	GND
6	+5V	18	GND
7	GND	19	GND
8	N.C	20	-5V
9	+5VSB	21	+5V
10	+12V	22	+5V
11	+12V	23	+5V
12	N.C	24	GND

2.22 RS-232/422/485 Serial Port Connector (CN14)

Pin	Signal	Pin	Signal
1	DCD1	2	DSR1
3	RXD1	4	RTS1
5	TXD1	6	CTS1
7	DTR1	8	RI1
9	GND	10	N.C
11	DCD2(422TXD-/485DATA-)	12	DSR2
13	RXD2(422RXD+)	14	RTS2
15	TXD2(422TXD+/485DATA+)	16	CTS2
17	DTR2(422RXD-)	18	RI2
19	GND	20	N.C
21	DCD3	22	DSR3
23	RXD3	24	RTS3
25	TXD3	26	CTS3
27	DTR3	28	+12V/+5V/RI3
29	GND	30	N.C
31	DCD4	32	DSR4
33	RXD4	34	RTS4
35	TXD4	36	CTS4
37	DTR4	38	+12V/+5V/RI4
39	GND	40	N.C

2.23 IrDA Connector (CN15)

Pin	Signal
1	+5V
2	N.C.
3	IRRX
4	GND
5	IRTX
6	N.C.

2.24 Audio 7.1 Channel Connector

Color	Signal
Blue	Line_In
Green	Line_Out
Pink	Mic_In
Orange	CEN/LFE
Black	Surround
Gray	Surround_Side

Chapter

3

**Award
BIOS Setup**

3.1 System Test and Initialization

These routines test and initialize board hardware. If the routines encounter an error during the tests, you will either hear a few short beeps or see an error message on the screen. There are two kinds of errors: fatal and non-fatal. The system can usually continue the boot up sequence with non-fatal errors. Non-fatal error messages usually appear on the screen along with the following instructions:

Press <F1> to RESUME

Write down the message and press the F1 key to continue the boot up sequence.

System configuration verification

These routines check the current system configuration against the values stored in the CMOS memory. If they do not match, the program outputs an error message. You will then need to run the BIOS setup program to set the configuration information in memory.

There are three situations in which you will need to change the CMOS settings:

1. You are starting your system for the first time
2. You have changed the hardware attached to your system
3. The CMOS memory has lost power and the configuration information has been erased.

The EMB-900M CMOS memory has an integral lithium battery backup for data retention. However, you will need to replace the complete unit when it finally runs down.

3.2 Award BIOS Setup

Awards BIOS ROM has a built-in Setup program that allows users to modify the basic system configuration. This type of information is stored in battery-backed CMOS RAM so that it retains the Setup information when the power is turned off.

Entering setup

Power on the computer and press immediately. This will allow you to enter Setup.

Standard CMOS Features

Use this menu for basic system configuration. (Date, time, IDE, etc.)

Advanced BIOS Features

Use this menu to set the advanced features available on your system.

Advanced Chipset Features

Use this menu to change the values in the chipset registers and optimize your system performance.

Integrated Peripherals

Use this menu to specify your settings for integrated peripherals. (Primary slave, secondary slave, keyboard, mouse etc.)

Power Management Setup

Use this menu to specify your settings for power management. (HDD power down, power on by ring etc.)

PnP/PCI Configurations

This entry appears if your system supports PnP/PCI.

PC Health Status

This menu shows you the status of PC.

Frequency/Voltage Control

This menu shows you the display of frequency/Voltage Control.

Load Fail-Safe Defaults

Use this menu to load the BIOS default values for the minimal/stable performance for your system to operate.

Load Optimized Defaults

Use this menu to load the BIOS default values that are factory settings for optimal performance system operations. While AWARD has designated the custom BIOS to maximize performance, the factory has the right to change these defaults to meet their needs.

Set Supervisor/User Password

Use this menu to set Supervisor/User Passwords.

Save and Exit Setup

Save CMOS value changes to CMOS and exit setup.

Exit Without Saving

Abandon all CMOS value changes and exit setup.

Note:

- 1. If on-chip serial ATA is enabled in BIOS and CompactFlash is not installed, it will take about one minute in detecting IDE drives after booting up.**
- 2. The EMB-900M needs different BIOSs to support different bit number LVDS LCDs. The default BIOS only supports**

24-bit LVDS LCD. If you need to use 18-bit, 36-bit or 48-bit LVDS LCD, please install the BIOS which supports 18-bit, 36-bit or 48-bit LVDS LCD in the CD-ROM.

3. You can refer to the "AAEON BIOS Item Description.pdf" file in the CD for the meaning of each setting in this chapter.

Chapter

4

**Driver
Installation**

The EMB-900M comes with a CD-ROM that contains all drivers and utilities that meet your needs.

In addition, you can activate the installation items through Auto-run program which will install each driver directly. If your system do not support Auto-run program or you cannot install drivers successfully, please read instructions below for further detailed installations.

Follow the sequence below to install the drivers:

Step 1 – Install INF driver

Step 2 – Install VGA Driver

Step 3 – Install LAN Driver

Step 4 – Install Audio Driver

Insert the EMB-900M CD-ROM into the CD-ROM Drive. And install the drivers from Step 1 to Step 4 in order.

4.1 Step 1 – Install INF Driver for Windows 2000/XP

1. Choose the folder according to the OS you used and then double click on the “**Setup.exe**” file.
2. Follow the instructions that the window will show you.
3. The system will help you install the driver automatically.
4. Please re-start your computer.

4.2 Step 2 – Install VGA Driver for Windows 2000/XP

1. Choose the folder according to the OS you used and then double click on the “**Setup.exe**” file.
2. Follow the instructions that the window will show you.
3. The system will help you install the driver automatically.
4. Please re-start your computer.

4.3 Step 3 – Install LAN Driver for Windows 2000/XP

1. Double click on the “**Setup YuKon Win.exe**” file.
2. Follow the instructions that the window will show you.
3. The system will help you install the driver automatically.

4.4 Step 4 – Install Audio Driver for Windows 2000/XP

1. Double click on the “**wdm_r121.exe**” file.
2. Follow the instructions that the window will show you.
3. The system will help you install the driver automatically.
4. Please re-start your computer.

Appendix

A

**Programming the
Watchdog Timer**

A.1 Programming

EMB-900M utilizes ITE 8712 chipset as its watchdog timer controller.

Below are the procedures to complete its configuration and the AAEON initial watchdog timer program is also attached based on which you can develop customized program to fit your application.

Configuring Sequence Description

After the hardware reset or power-on reset, the ITE 8712 enters the normal mode with all logical devices disabled except KBC. The initial state (enable bit) of this logical device (KBC) is determined by the state of pin 121 (DTR1#) at the falling edge of the system reset during power-on reset.

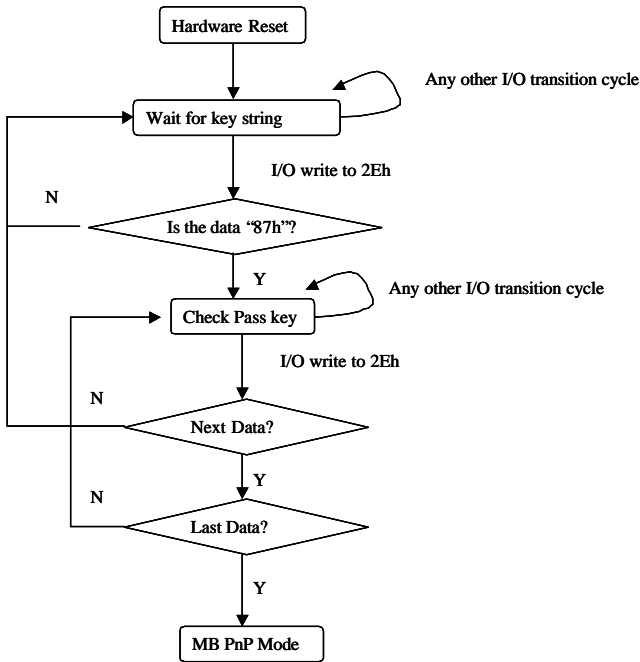

There are three steps to complete the configuration setup: (1) Enter the MB PnP Mode; (2) Modify the data of configuration registers; (3) Exit the MB PnP Mode. Undesired result may occur if the MB PnP Mode is not exited normally.

(1) Enter the MB PnP Mode

To enter the MB PnP Mode, four special I/O write operations are to be performed during Wait for Key state. To ensure the initial state of the key-check logic, it is necessary to perform four write operations to the Special Address port (2EH). Two different enter keys are provided to select configuration ports (2Eh/2Fh) of the next

step.

	Address Port	Data Port
87h, 01h, 55h, 55h:	2Eh	2Fh

(2) Modify the Data of the Registers

All configuration registers can be accessed after entering the MB PnP Mode. Before accessing a selected register, the content of Index 07h must be changed to the LDN to which the register belongs, except some Global registers.

(3) Exit the MB PnP Mode

Set bit 1 of the configure control register (Index=02h) to 1 to exit the MB PnP Mode.

WatchDog Timer Configuration Registers

LDN	Index	R/W	Reset	Configuration Register or Action
All	02H	W	N/A	Configure Control
07H	71H	R/W	00H	WatchDog Timer Control Register
07H	72H	R/W	00H	WatchDog Timer Configuration Register
07H	73H	R/W	00H	WatchDog Timer Time-out Value Register

Configure Control (Index=02h)

This register is write only. Its values are not sticky; that is to say, a hardware reset will automatically clear the bits, and does not require the software to clear them.

Bit	Description
7-2	Reserved
1	Returns to the Wait for Key state. This bit is used when the configuration sequence is completed
0	Resets all logical devices and restores configuration registers to their power-on states.

WatchDog Timer Control Register (Index=71h, Default=00h)

Bit	Description
7	WDT is reset upon a CIR interrupt
6	WDT is reset upon a KBC (mouse) interrupt
5	WDT is reset upon a KBC (keyboard) interrupt
4	WDT is reset upon a read or a write to the Game Port base address
3-2	Reserved
1	Force Time-out. This bit is self-clearing
0	WDT Status
	1: WDT value reaches 0.
	0: WDT value is not 0

WatchDog Timer Configuration Register (Index=72h, Default=00h)

Bit	Description
7	WDT Time-out value select
	1: Second
	0: Minute
6	WDT output through KRST (pulse) enable
5-4	Reserved
3-0	Select the interrupt level ^{Note} for WDT

WatchDog Timer Time-out Value Register (Index=73h, Default=00h)

Bit	Description
7-0	WDT Time-out value 7-0

A.2 IT8712 Watchdog Timer Initial Program

```
.MODEL SMALL
```

```
.CODE
```

Main:

```
CALL Enter_Configuration_mode
```

```
CALL Check_Chip
```

```
mov cl, 7
```

```
call Set_Logic_Device
```

```
;time setting
```

```
mov cl, 10 ; 10 Sec
```

```
dec al
```

Watch_Dog_Setting:

```
;Timer setting
```

```
mov al, cl
```

```
mov cl, 73h
```

```
call Superio_Set_Reg
```

```
;Clear by keyboard or mouse interrupt
```

```
mov al, 0f0h
```

```
mov cl, 71h
```

```
call Superio_Set_Reg
```

```
;unit is second.
```

```
mov al, 0C0H
```

```
mov cl, 72h
```

```
call Superio_Set_Reg
```

```
; game port enable  
mov cl, 9  
call Set_Logic_Device
```

```
Initial_OK:  
CALL Exit_Configuration_mode  
MOV AH,4Ch  
INT 21h
```

```
Enter_Configuration_Mode PROC NEAR  
MOV SI,WORD PTR CS:[Offset Cfg_Port]
```

```
MOV DX,02Eh  
MOV CX,04h  
Init_1:  
MOV AL,BYTE PTR CS:[SI]  
OUT DX,AL  
INC SI  
LOOP Init_1  
RET  
Enter_Configuration_Mode ENDP
```

```
Exit_Configuration_Mode PROC NEAR  
MOV AX,0202h  
CALL Write_Configuration_Data
```

```
RET
Exit_Configuration_Mode ENDP
```

```
Check_Chip PROC NEAR
```

```
MOV AL,20h
CALL Read_Configuration_Data
CMP AL,87h
JNE Not_Initial
```

```
MOV AL,21h
CALL Read_Configuration_Data
CMP AL,12h
JNE Not_Initial
```

```
Need_Initial:
```

```
STC
RET
```

```
Not_Initial:
```

```
CLC
RET
Check_Chip ENDP
Read_Configuration_Data PROC NEAR
MOV DX,WORD PTR CS:[Cfg_Port+04h]
OUT DX,AL
```

```
MOV DX,WORD PTR CS:[Cfg_Port+06h]
IN AL,DX
RET
Read_Configuration_Data ENDP
```

```
Write_Configuration_Data PROC NEAR
MOV DX,WORD PTR CS:[Cfg_Port+04h]
OUT DX,AL
XCHG AL,AH
MOV DX,WORD PTR CS:[Cfg_Port+06h]
OUT DX,AL
RET
Write_Configuration_Data ENDP
```

```
Superio_Set_Reg proc near
push ax
MOV DX,WORD PTR CS:[Cfg_Port+04h]
mov al,cl
out dx,al
pop ax
inc dx
out dx,al
ret
Superio_Set_Reg endp.Set_Logic_Device proc near
Set_Logic_Device proc near
```

```
push ax
push cx
xchg al,cl
mov cl,07h
call Superio_Set_Reg
pop cx
pop ax
ret
Set_Logic_Device endp
```

```
;Select 02Eh->Index Port, 02Fh->Data Port
Cfg_Port DB 087h,001h,055h,055h
```

```
DW 02Eh,02Fh
```

END Main

Note: Interrupt level mapping

0Fh-Dh: not valid

0Ch: IRQ12

.

.

03h: IRQ3

02h: not valid

01h: IRQ1

































00h: no interrupt selected

Appendix

B

I/O Information

B.1 I/O Address Map

	[00000000 - 0000000F]	Direct memory access controller
	[00000000 - 00000CF7]	PCI bus
	[00000010 - 0000001F]	Motherboard resources
	[00000020 - 00000021]	Programmable interrupt controller
	[00000022 - 0000003F]	Motherboard resources
	[00000040 - 00000043]	System timer
	[00000044 - 0000005F]	Motherboard resources
	[00000060 - 00000060]	Standard 101/102-Key or Microsoft Natural PS/2 Keyboard
	[00000061 - 00000061]	System speaker
	[00000062 - 00000063]	Motherboard resources
	[00000064 - 00000064]	Standard 101/102-Key or Microsoft Natural PS/2 Keyboard
	[00000065 - 0000006F]	Motherboard resources
	[00000070 - 00000073]	System CMOS/real time clock
	[00000074 - 0000007F]	Motherboard resources
	[00000080 - 00000090]	Direct memory access controller
	[00000091 - 00000093]	Motherboard resources
	[00000094 - 0000009F]	Direct memory access controller
	[000000A0 - 000000A1]	Programmable interrupt controller
	[000000A2 - 000000BF]	Motherboard resources
	[000000C0 - 000000DF]	Direct memory access controller
	[000000E0 - 000000EF]	Motherboard resources
	[000000F0 - 000000FF]	Numeric data processor
	[00000170 - 00000177]	Secondary IDE Channel
	[000001F0 - 000001F7]	Primary IDE Channel
	[00000274 - 00000277]	ISAPNP Read Data Port
	[00000279 - 00000279]	ISAPNP Read Data Port
	[00000290 - 0000029F]	Motherboard resources
	[000002E8 - 000002EF]	Communications Port (COM4)
	[000002F8 - 000002FF]	Communications Port (COM2)
	[00000376 - 00000376]	Secondary IDE Channel
	[00000378 - 0000037F]	Printer Port (LPT1)
	[000003B0 - 000003BB]	Intel(R) 82915G/GV/910GL Express Chipset Family
	[000003C0 - 000003DF]	Intel(R) 82915G/GV/910GL Express Chipset Family



B.2 1st MB Memory Address Map

[00000000 - 0009FFFF]	System board
[000A0000 - 000BFFFF]	Intel(R) 82915G/GV/910GL Express Chipset Family
[000A0000 - 000BFFFF]	PCI bus
[000C0000 - 000DFFFF]	PCI bus
[000CC000 - 000CFFFF]	System board
[000D7800 - 000D7FFF]	System board
[000E0000 - 000EFFFF]	System board
[000F0000 - 000F8FFF]	System board
[000FC000 - 000FFFFF]	System board
[00100000 - 0F6EFFFF]	System board
[0F6F0000 - 0F6FFFFF]	System board
[0F700000 - FEBFFFFF]	PCI bus
[C0000000 - CFFFFFFF]	Intel(R) 82915G/GV/910GL Express Chipset Family
[D0000000 - D00FFFFF]	Intel(R) 82801FB/FBM PCI Express Root Port - 2660
[D0020000 - D0023FFF]	Marvell Yukon 88E8053 PCI-E Gigabit Ethernet Controller #2
[D0100000 - D01FFFFF]	Intel(R) 82801FB/FBM PCI Express Root Port - 2662
[D0120000 - D0123FFF]	Marvell Yukon 88E8053 PCI-E Gigabit Ethernet Controller
[D0200000 - D027FFFF]	Intel(R) 82915G/GV/910GL Express Chipset Family
[D0280000 - D02FFFFF]	Intel(R) 82915G/GV/910GL Express Chipset Family
[D0300000 - D033FFFF]	Intel(R) 82915G/GV/910GL Express Chipset Family
[D0340000 - D0343FFF]	Microsoft UAA Bus Driver for High Definition Audio
[D0344000 - D03443FF]	Intel(R) 82801FB/FBM USB2 Enhanced Host Controller - 265C
[E0000000 - EFFFFFFF]	Motherboard resources
[FEC00000 - FEC00FFF]	System board
[FED13000 - FED1DFFF]	System board
[FED20000 - FED8FFFF]	System board
[FEE00000 - FEE00FFF]	System board
[FFB00000 - FFB7FFFF]	System board
[FFB80000 - FFBFFFFFFF]	Intel(r) 82802 Firmware Hub Device
[FFF00000 - FFFFFFFF]	System board

B.3 IRQ Mapping Chart

	(ISA) 0	System timer
	(ISA) 1	Standard 101/102-Key or Microsoft Natural PS/2 Keyboard
	(ISA) 3	Communications Port (COM2)
	(ISA) 4	Communications Port (COM1)
	(ISA) 6	Standard floppy disk controller
	(ISA) 8	System CMOS/real time clock
	(ISA) 9	Microsoft ACPI-Compliant System
	(ISA) 10	Communications Port (COM3)
	(ISA) 11	Communications Port (COM4)
	(ISA) 12	PS/2 Compatible Mouse
	(ISA) 13	Numeric data processor
	(ISA) 14	Primary IDE Channel
	(ISA) 15	Secondary IDE Channel
	(PCI) 5	Intel(R) 82801FB/FBM SMBus Controller - 266A
	(PCI) 16	Intel(R) 82801FB/FBM PCI Express Root Port - 2660
	(PCI) 16	Intel(R) 82801FB/FBM USB Universal Host Controller - 265B
	(PCI) 16	Intel(R) 82915G/GV/910GL Express Chipset Family
	(PCI) 16	Marvell Yukon 88E8053 PCI-E Gigabit Ethernet Controller #2
	(PCI) 16	Microsoft UAA Bus Driver for High Definition Audio
	(PCI) 17	Intel(R) 82801FB/FBM PCI Express Root Port - 2662
	(PCI) 17	Marvell Yukon 88E8053 PCI-E Gigabit Ethernet Controller
	(PCI) 18	Intel(R) 82801FB/FBM USB Universal Host Controller - 265A
	(PCI) 19	Intel(R) 82801FB/FBM USB Universal Host Controller - 2659
	(PCI) 23	Intel(R) 82801FB/FBM USB Universal Host Controller - 2658
	(PCI) 23	Intel(R) 82801FB/FBM USB2 Enhanced Host Controller - 265C

B.4 DMA Channel Assignments

	2	Standard floppy disk controller
	4	Direct memory access controller