

AEC-7450

Fanless Embedded Controller

Intel® Pentium® M 1.8 GHz

Wide temperature controller

Copyright Notice

This document is copyrighted, 2008. All rights are reserved. The original manufacturer reserves the right to make improvements to the products described in this manual at any time without notice.

No part of this manual may be reproduced, copied, translated, or transmitted in any form or by any means without the prior written permission of the original manufacturer. Information provided in this manual is intended to be accurate and reliable. However, the original manufacturer assumes no responsibility for its use, or for any infringements upon the rights of third parties that may result from its use.

The material in this document is for product information only and is subject to change without notice. While reasonable efforts have been made in the preparation of this document to assure its accuracy, AAEON assumes no liabilities resulting from errors or omissions in this document, or from the use of the information contained herein.

AAEON reserves the right to make changes in the product design without notice to its users.

Acknowledgments

All other products' name or trademarks are properties of their respective owners.

- Award is a trademark of Award Software International, Inc.
- CompactFlash™ is a trademark of the Compact Flash Association.
- Intel®, Pentium® M are trademarks of Intel® Corporation.
- Microsoft Windows® is a registered trademark of Microsoft Corp.
- PC/AT, PS/2, and VGA are trademarks of International Business Machines Corporation.

All other product names or trademarks are properties of their respective owners.

Packing List

Before you begin operating your PC, please make sure that the following materials are enclosed:

- 1 AEC-7450 Embedded Controller
- 1 Phoenix Power Connector
- 2 Wallmount Brackets
- 1 Screw Package
- 1 CD-ROM for manual (in PDF format) and drivers

If any of these items should be missing or damaged, please contact your distributor or sales representative immediately.

Safety & Warranty

1. Read these safety instructions carefully.
2. Keep this user's manual for later reference.
3. Disconnect this equipment from any AC outlet before cleaning. Do not use liquid or spray detergents for cleaning. Use a damp cloth.
4. For pluggable equipment, the power outlet must be installed near the equipment and must be easily accessible.
5. Keep this equipment away from humidity.
6. Put this equipment on a firm surface during installation. Dropping it or letting it fall could cause damage.
7. The openings on the enclosure are for air convection. Protect the equipment from overheating. **DO NOT COVER THE OPENINGS.**
8. Make sure the voltage of the power source is correct before connecting the equipment to the power outlet.
9. Position the power cord so that people cannot step on it. Do not place anything over the power cord.
10. All cautions and warnings on the equipment should be noted.
11. If the equipment is not used for a long time, disconnect it from the power source to avoid damage by transient over-voltage.
12. Never pour any liquid into an opening. This could cause fire or electrical shock.
13. Never open the equipment. For safety reasons, only qualified service personnel should open the equipment.
14. If any of the following situations arises, get the equipment checked by service personnel:
 - a. The power cord or plug is damaged.
 - b. Liquid has penetrated into the equipment.
 - c. The equipment has been exposed to moisture.

- d. The equipment does not work well, or you cannot get it to work according to the user's manual.
 - e. The equipment has been dropped and damaged.
 - f. The equipment has obvious signs of breakage.
15. DO NOT LEAVE THIS EQUIPMENT IN AN ENVIRONMENT WHERE THE STORAGE TEMPERATURE IS BELOW -20°C (-4°F) OR ABOVE 60°C (140°F). IT MAY DAMAGE THE EQUIPMENT.

FCC

Warning!



This device complies with Part 15 FCC Rules. Operation is subject to the following two conditions: (1) this device may not cause harmful interference, and (2) this device must accept any interference received including interference that may cause undesired operation.

Below Table for China RoHS Requirements

产品中有毒有害物质或元素名称及含量

AAEON Boxer/ Industrial System

部件名称	有毒有害物质或元素					
	铅 (Pb)	汞 (Hg)	镉 (Cd)	六价铬 (Cr(VI))	多溴联苯 (PBB)	多溴二苯醚 (PBDE)
印刷电路板 及其电子组件	×	○	○	○	○	○
外部信号 连接器及线材	×	○	○	○	○	○
外壳	×	○	○	○	○	○
中央处理器 与内存	×	○	○	○	○	○
硬盘	×	○	○	○	○	○
电源	×	○	○	○	○	○

O: 表示该有毒有害物质在该部件所有均质材料中的含量均在 SJ/T 11363-2006 标准规定的限量要求以下。

X: 表示该有毒有害物质至少在该部件的某一均质材料中的含量超出 SJ/T 11363-2006 标准规定的限量要求。

备注:

一、此产品所标示之环保使用期限，系指在一般正常使用状况下。

二、上述部件物质中央处理器、内存、硬盘、电源为选购品。

Contents

Chapter 1 General Information

1.1 Introduction.....	1-2
1.2 Features	1-4
1.3 Specifications	1-5

Chapter 2 Hardware Installation Guide

2.1 Dimension	2-2
2.2 Installing CompactFlash Card	2-4
2.3 Installing Solid State Disk.....	2-8
2.4 Wallmount Kit Installation.....	2-14

Chapter 3 Phoenix BIOS Setup

3.1 Introduction.....	3-2
-----------------------	-----

Chapter 4 Driver Installation

4.1 Installation	4-3
------------------------	-----

Appendix A Programming The Watchdog Timer

A.1 Programming	A-2
-----------------------	-----

Chapter

1

**General
Information**

1.1 Introduction

Due to the growing popularity from the IPC market, the newest Boxer series AEC-7450 has been introduced by AAEON. AEC-7450 utilizes an Intel® Pentium® processor without a fan.

New Innovation for Entertainment Multimedia Domain

In this era of information explosion, the advertising of consumer products will not be confined to the family television, but will also spread to high-traffic public areas, like department stores, the bus, transportation station, the supermarket etc. The advertising marketing industry will resort to every conceivable means to transmit product information to consumers. System integrators will need a multifunction device to satisfy commercial needs for such public advertising.

Stable Design for Rugged Environment

The AEC-7450 is designed for rugged environments due to the following reasons; first, it can withstand tough vibration testing up to 3G rms. With the anti-vibration hard drive device option, the AEC-7450 can be used in high vibration environments. In addition, the AEC-7450 offers low power consumption system that while operating in ambient temperatures ranging from -40° to 70°C. The MTBF(Mean Time Before Failure) rating states that the AEC-7450 can operate up to 100,000 hours at 30°C ambient temperature,

which indicates its careful and long-life design.

The AEC-7450 is a standalone high performance controller designed for long-life operation and with high reliability. It can replace traditional methods and become the mainstream controller for the multimedia entertainment market.

1.2 Features

- Fanless Design with Intel[®] Pentium[®] M 1.8 GHz Processor
- Onboard 1GB DDR SD RAM ECC
- Wide Temperature Operating Design
- DC 9~30V Input With Phoenix Connector And Optional External AC Input Power Adapter
- Wallmount Design And Suit For Industrial Applications
- Windows XP Pro, Windows XP Embedded And Linux Red Hat Are Ready For Applications

1.3 Specifications

System

- CPU Intel[®] Pentium[®] M 1.8GHz Processor
- Memory Onboard 1GB DDR SD RAM ECC
- VGA D-sub 15 VGA Connector
- Ethernet 100/1000Base-TX, RJ-45 x 2
- Keyboard/ Mouse Keyboard/Mouse Connector in USB type
- Solid Storage Disk Internal Type II CompactFlash[™] slot x 1, SATA x 1
- Serial port RS-232 x 2 (COM1/COM2)
- Audio Audio port x 1 (Line-in x 1, Line-out x1, MIC-in x1)
- USB USB2.0 port x 4
- Parallel Parallel Port x 1
- Watchdog Timer Generates a time-out system reset
- Power Supply DC Input: 9V DC~30V DC
AC Input: External power adapter (Optional)

Mechanical and Environmental

- Construction Aluminum Alloy Chassis
- Color Navy Blue

- Mounting Wallmount
- Dimension 8.3" (W) x 6.5" (D) x 3"(H)
(212mm x 166mm x 76.4mm)
- Net weight 7.26 lb (3.3 kg)
- Gross weight 8.8 lb (4 kg)
- Operating Temperature -40°F ~ 158°F (-40°C ~ 70°C)
- Operating Humidity 5 ~ 90% @ 40°C,
non-condensing
- Vibration 3g rms/ 5~500Hz/ random
operation
- Shock 50g peak acceleration (11
msec. duration)
- EMC CE/FCC Class A

Chapter

2

**Hardware
Installation
Guide**

2.1 Dimension

AEC-7450 Dimension

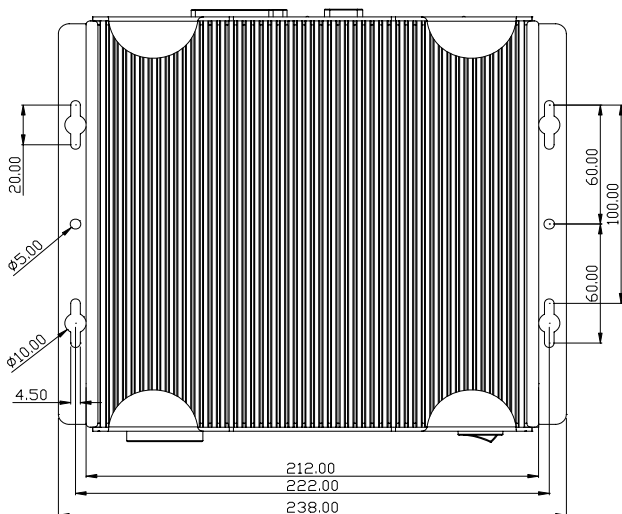

Front Side

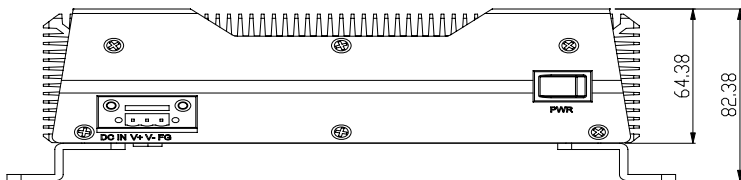

Rear Side

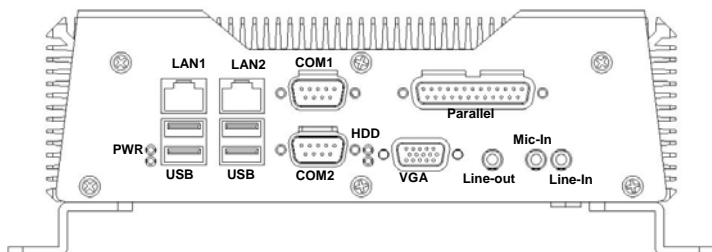

2.2 Installing Compact Flash Card

For Compact Flash Card (CF card) installation, you have to disassemble the bottom lid of AEC-7450 and some components and covers in the AEC-7450.

Step 1: Unfasten the all screws on the rear panel, the front panel and the bottom lid.

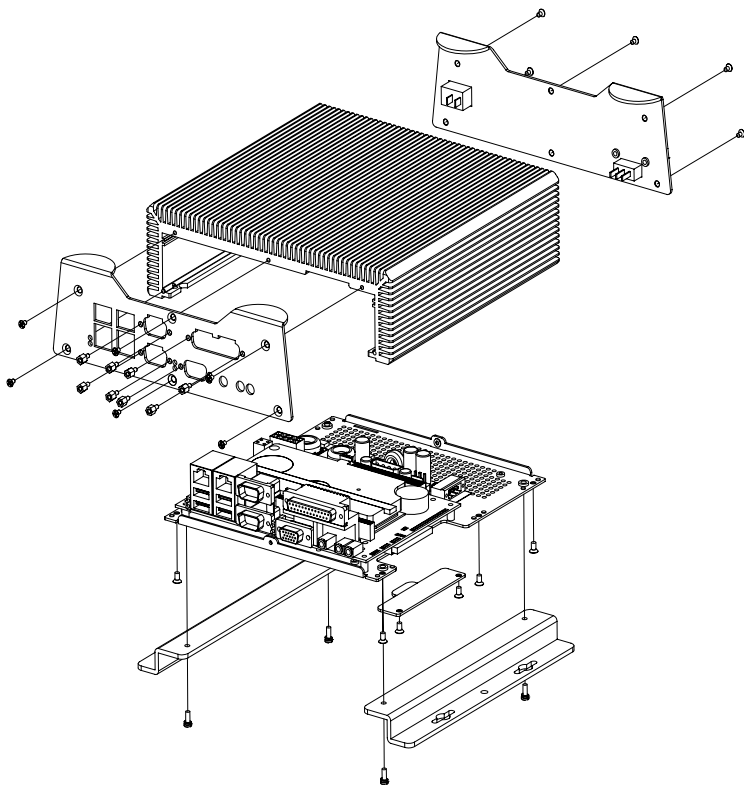

Step 2: Insert the CF card into the CF slot.

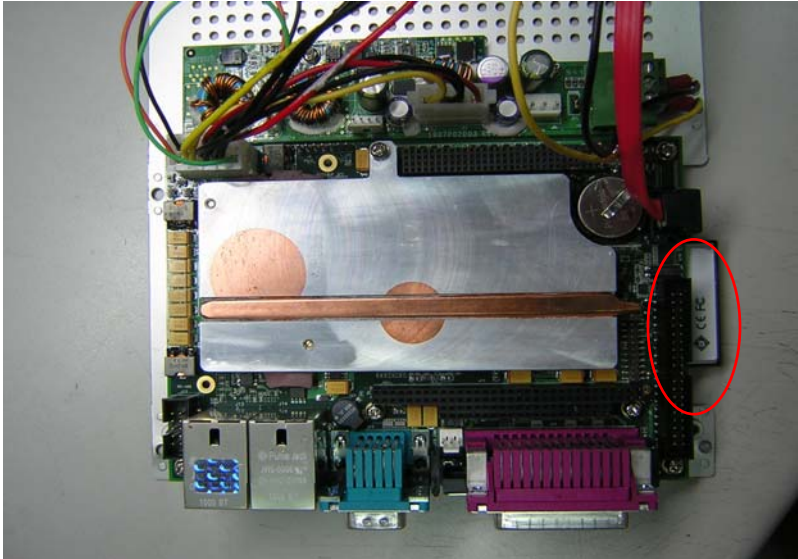

Step 3: Combine the chassis and t and fasten the screws

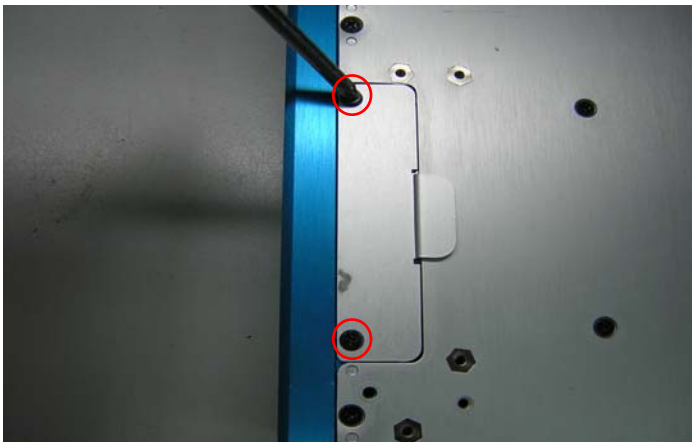
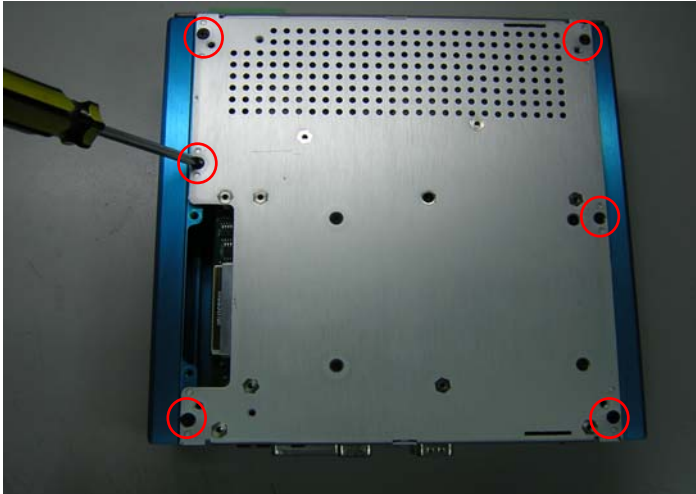

Step 4: Fasten the one screw on the front panel and one screw on the front panel

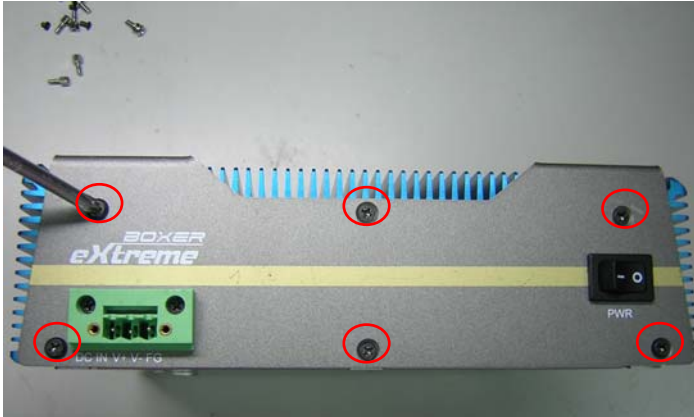

Step 5: Fasten the one screw on the front panel and one screw on the real panel

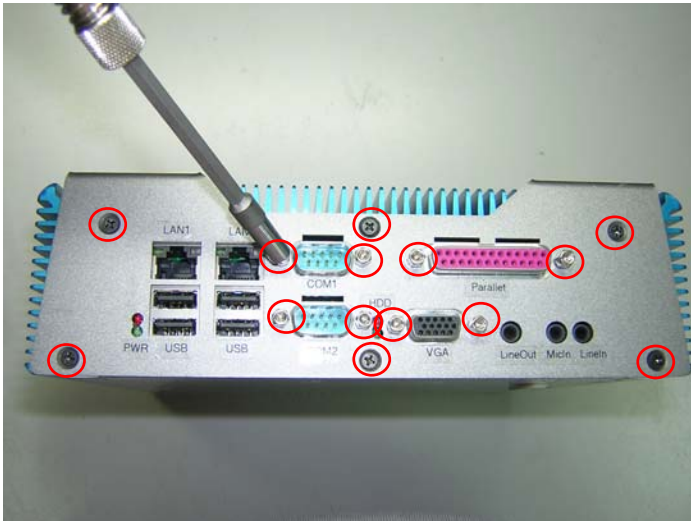

2.3 Installing Solid State Disk

For Solid State Disk (SSD) installation, you have to disassemble the bottom lid of AEC-7450 and some components and covers in the AEC-7450. After disassembling the AEC-7450, you have to get the SSD module ready for the proceeding installation.

Step 1: Unfasten the all screws on the rear panel, the front panel and the bottom lid.

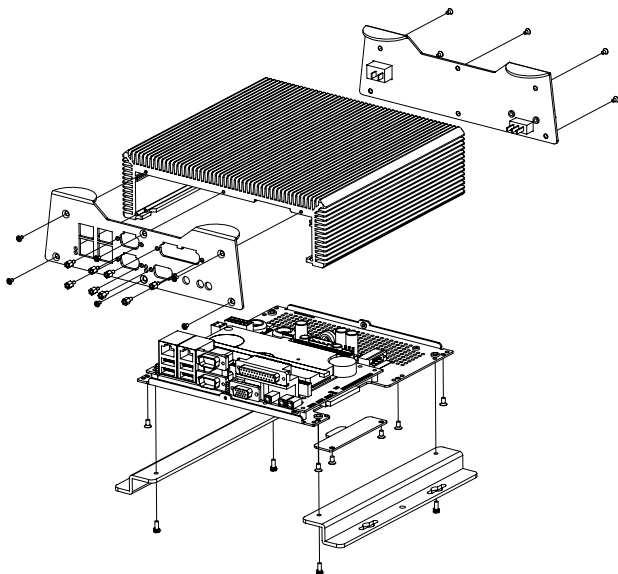

Step 2: Fasten the four SSD screws and cover with the four black Damper and assembly the SSD chassis

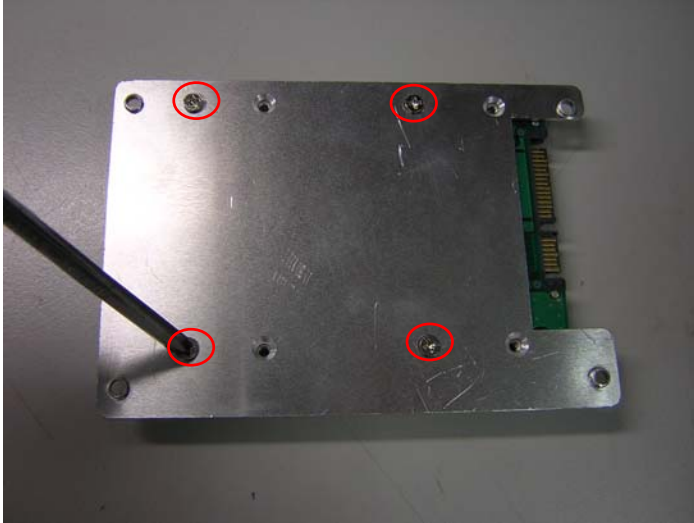

Step 3: Connect the SSD cable

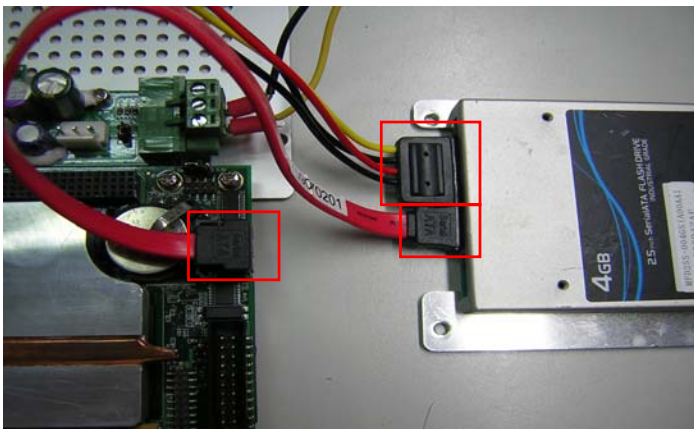

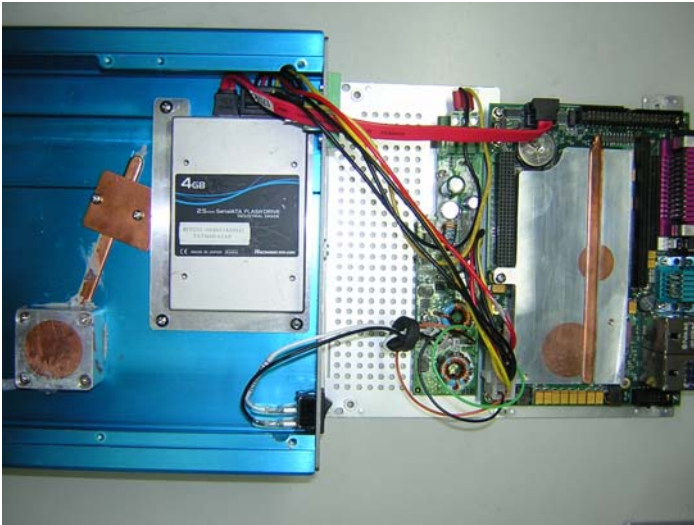

Step 4: Fasten the four SSD screws



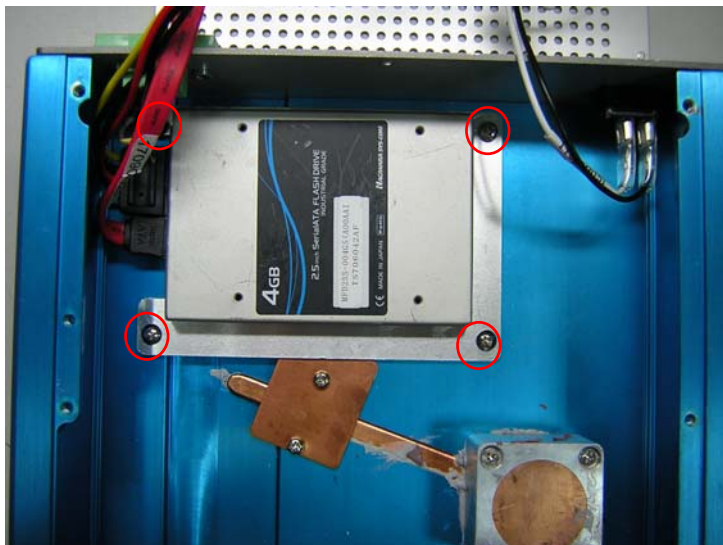

Step 5: Fasten the eight screws on the back of the AEC-7450

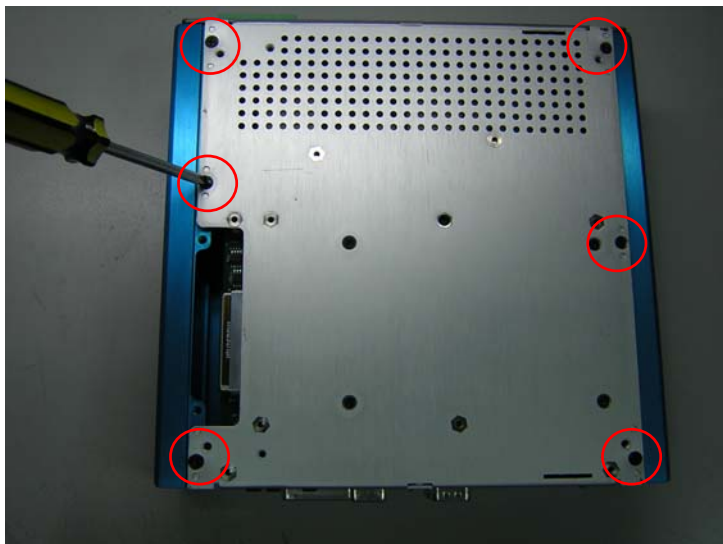

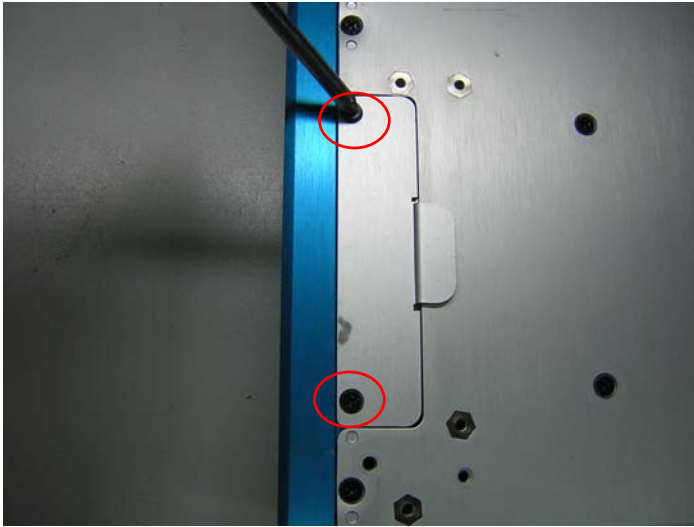

Step 6: Fasten the one screw on the front panel and one screw on the front panel

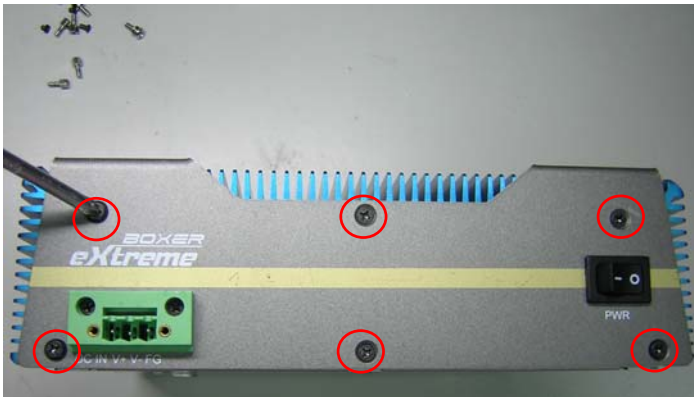

Step 7: Fasten the one screw on the front panel and one screw on the rear panel

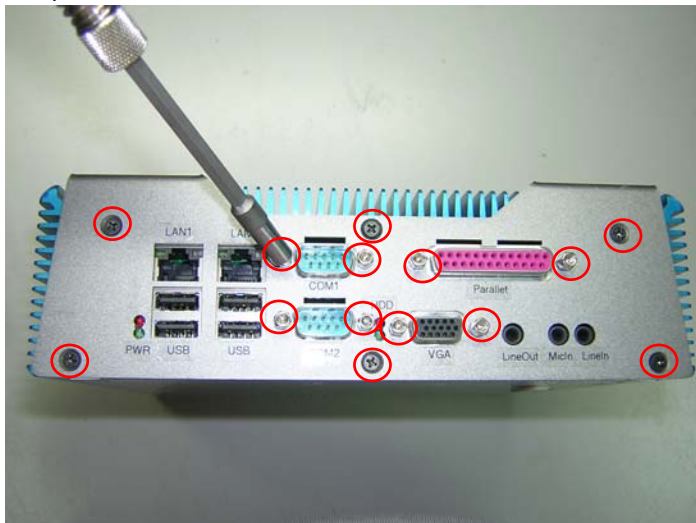

2.4 Wallmount Kit Installation

Step 1: Get the brackets ready and fasten appropriate three screws on each bracket. After fastening the two brackets on the bottom lid of AEC-7450, the wallmount kit installation is finished

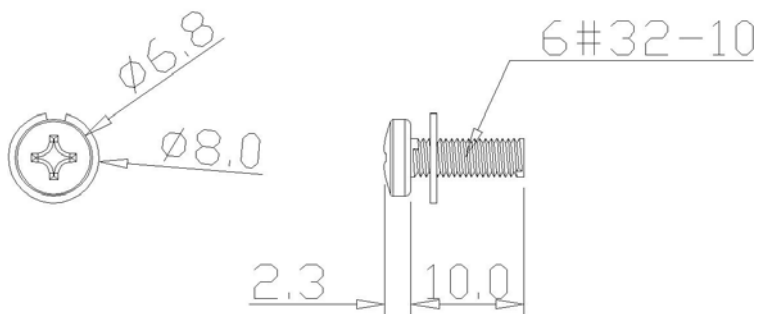
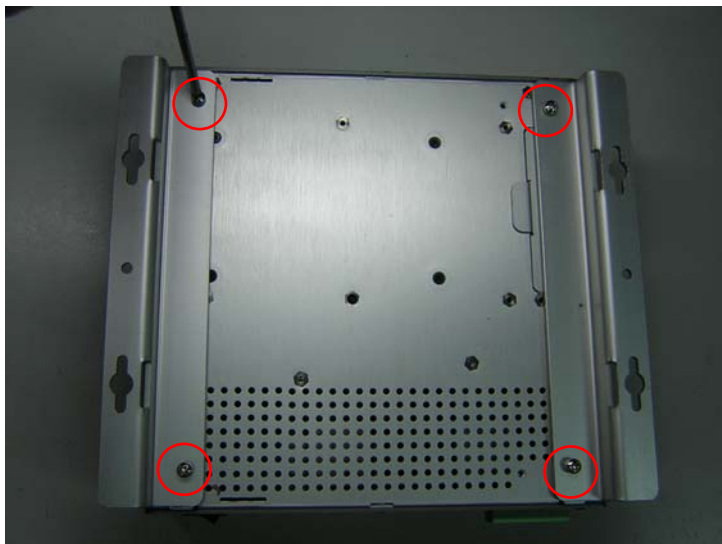

Chapter

3

**Phoenix
BIOS Setup**

3.1 Introduction

The Phoenix BIOS in your computer is a customized version of standard BIOS for IBM PC AT-compatible personal computers. It supports the Intel®x86 and compatible processors. The BIOS provides critical low-level support for the system central processing, memory, and I/O subsystems.

This manual describes the Phoenix BIOS Setup program. The Setup program lets you modify basic system configuration settings and control the special features of your computer. The settings are then stored in a dedicated battery-backed memory, called CMOS RAM, that retains the information when the power is turned off.

The Setup program uses a number of menus for making changes and turning the special features on or off.

To start the Phoenix BIOS Setup utility turn on or reboot your system. PhoenixBIOS displays this message:

Press <F2> to enter SETUP

Pressing <F2> lets you enter the Setup utility. The first screen is the Main Menu.

The Main Menu

The Main Menu screen is shown below.

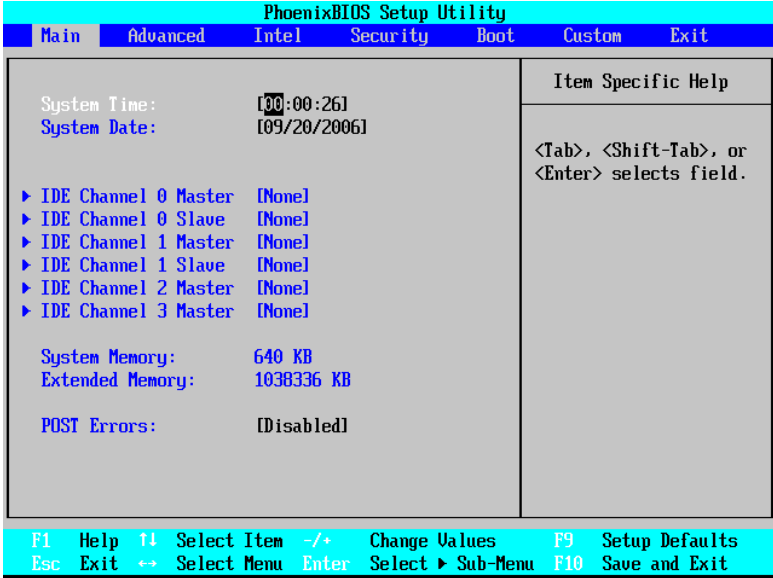

The following subsections explain the purpose of main functional areas of the screen and give description of the fields.

The Menu Bar

The Menu Bar at the top of the window lists these selections:

Menu	Purpose
Main	Basic system configuration
Advanced	Use to set the Advanced Features available on

	your system's chipset
Intel	Intel chipset-specific parameters
Security	Configuration of system security settings
Boot	Boot sequence configuration
Custom	Configuration of special board features
Exit	Exits the current menu

Use the left and right (←, →) arrow keys to make a selection.

For a description on exiting the Main Menu, see "Exit Menu" section below.

The Legend Bar

The legend bar at the bottom of the screen lists the keys to navigate within menu system, to make your selections or exit the current menu. The following table describes the legend keys and their alternates.

Key	Function
<F1> or <Alt-H>	General Help window (See below)
<Esc>	Exit this menu.
← or → arrow keys	Select a different menu

↑ or ↓ arrow keys	Move cursor up and down
<Tab> or <Shift-Tab>	Cycle cursor between the fields
<Home> or <End>	Move cursor to top or bottom of window
<PgUp> or <PgDn>	Move cursor to next or previous page
<F5> or <->	Select the next lower value for the field
<F6> or <+> or <Space>	Select the next higher value for the field
<F9>	Load the Default Configuration values for the complete BIOS
<F10>	Save and exit
<Enter>	Execute command or select ► Submenu
<Alt-R>	Refresh screen

To select an item, use the arrow keys to move the cursor to the field you want. Then use the plus-and-minus value keys to select a value for that field. The Save Values command in the Exit Menu save the values currently displayed in all the menus.

A pointer ► marks all submenus. To display a submenu, use the arrow keys to move the cursor to the submenu you want, and then press <Enter>.

The Item Specific Help Window

The help window on the right side of each menu screen displays the field-specific help text, it updates as you move the cursor from field to field.

The General Help Window

Pressing <F1> or <Alt-H> on any menu brings up the General Help window that describes the legend keys and their alternates.

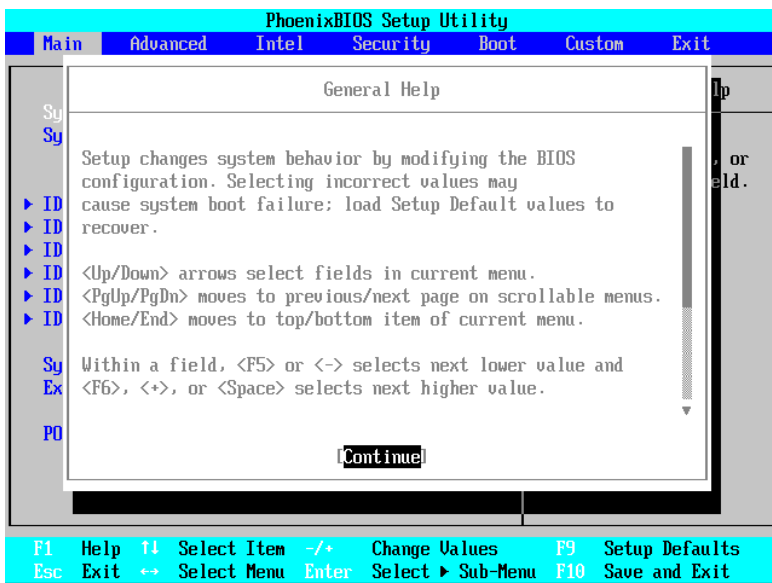

The scroll bar on the right of any window indicates that there is more than one page of information in the window. Use <PgUp> and <PgDn> to display all the pages. Pressing <Home> and <End> displays the first and last page. Pressing <Enter> displays each page and then exits the window.

Press <Esc> to exit the window.

Main Menu Selections

Main Menu screen offers possibility to set system time and date, to enter type, specifications, and control options for the devices connected to IDE channels. Additionally, this menu screen gives information on the amount of the detected main and extended system memory, and allows to set system response to POST errors.

Warning:

Incorrect settings may cause your system to malfunction. To correct mistakes, return to Setup and restore the Setup Defaults with <F9> and re-enter the correct drive parameters.

The Advanced Menu

The Advanced Menu screen is shown below.

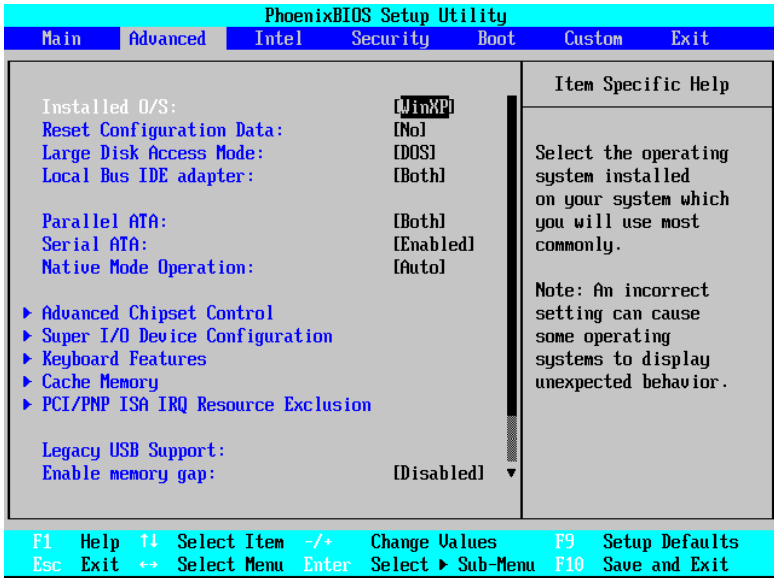

This menu screen gives access to advanced system configuration parameters. Submenus allow setting thermal and power control options, configuring serial and parallel ports, adjusting keyboard behavior, enabling cache memory use for various system components, and reserving IRQs for legacy ISA devices.

Remember, that incorrect settings can cause your system to malfunction.

The Intel Menu

The Intel menu screen offers a number of submenus containing chipset-specific control fields.

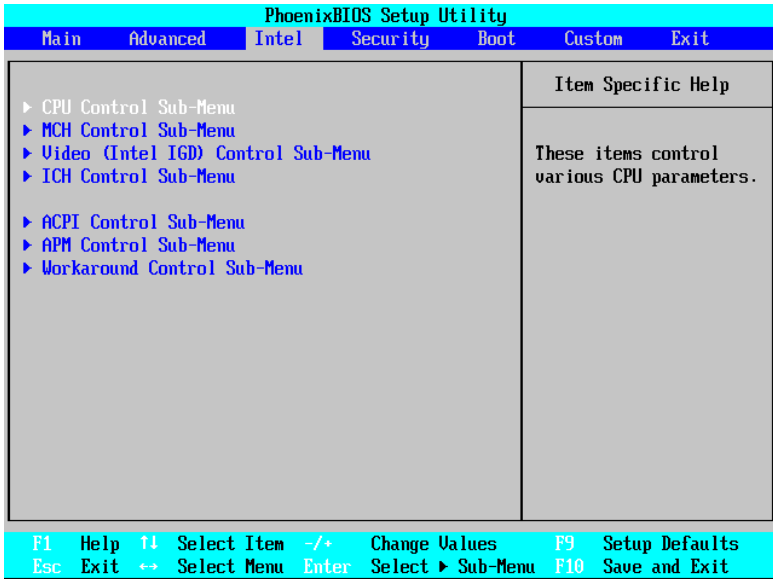

CPU power and thermal management, MCH and ICH control options, integrated graphics controller parameters, as well as ACPI and APM control – all these features are available via submenus on this screen.

The Security Menu

Various system security settings, such as supervisor password and other access control parameters, are collected at this menu screen.

PhoenixBIOS Setup Utility			
Main	Advanced	Intel	Security
			Boot Custom Exit
FirstWare Authentication Level	[High]		Item Specific Help
Supervisor Password Is:	Clear		Select FirstWare authentication level
User Password Is:	Clear		
Set Supervisor Password	[Enter]		
Set User Password			
Diskette access:			
Fixed disk boot sector:	[Normal]		
Virus check reminder:	[Disabled]		
System backup reminder:	[Disabled]		
Password on boot:			
F1 Help ↑↓ Select Item -/+ Change Values	F9 Setup Defaults		
Esc Exit ↔ Select Menu Enter Select ▶ Sub-Menu	F10 Save and Exit		

The Boot Menu

PhoenixBIOS Setup Utility						
Main	Advanced	Intel	Security	Boot	Custom	Exit
+Removable Devices +Hard Drive CD-ROM Drive Network Boot				Item Specific Help Keys used to view or configure devices: <Enter> expands or collapses devices with a + or - <Ctrl+Enter> expands all <Shift + 1> enables or disables a device. <+> and <-> moves the device up or down. <n> May move removable device between Hard Disk or Removable Disk <d> Remove a device that is not installed.		
F1	Help	↑↓	Select Item	-/+	Change Values	F9 Setup Defaults
Esc	Exit	↔	Select Menu	Enter	Select ▶ Sub-Menu	F10 Save and Exit

After you turn on your computer, it will attempt to load the operating system from the chosen device. If it cannot find the operating system on that device, it will attempt to load it from one or more other devices in the order specified in the Boot Menu. Boot devices (i.e., with access to an operating system) can include: hard drives, floppy drives, CD ROMs, removable devices (e.g., Iomega Zip drives), and network cards.

Use the keys described in Item Specific Help to arrange devices in order to specify the priority of the devices from which the BIOS will attempt to boot the operating system.

The Custom Menu

Selecting "Custom" from menu bar on the Main Menu displays a menu shown below.

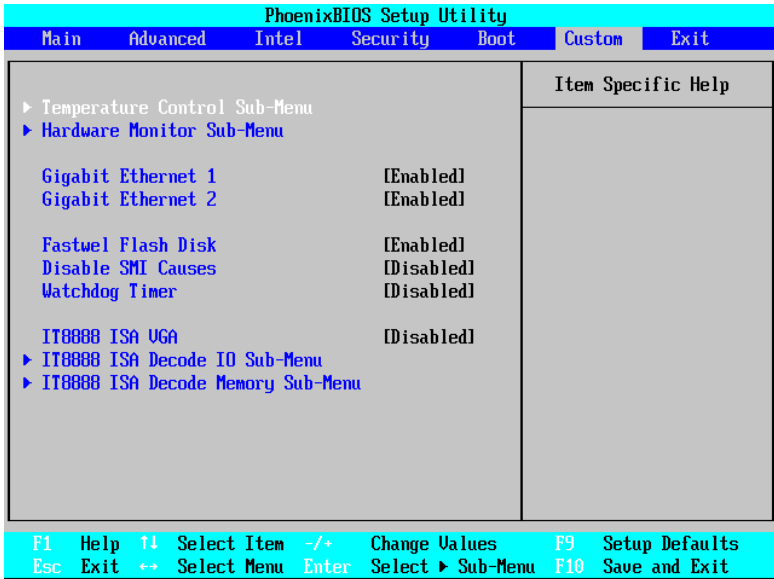

Temperature Control submenu contains a number of fields with some ACPI settings, such as temperature threshold values and control constants. Hardware Monitor submenu displays temperatures and voltages supervised by the hardware monitor. This menu screen also provides possibility to control other product-specific features, including Gigabit Ethernet channels, Fastwel flash disk, SMI sources, watchdog timer, and IT8888 PCI-to-ISA bridge.

The Exit Menu

Selecting "Exit" from menu bar on the Main Menu or pressing <Esc> at any Main Menu screen displays the following menu.

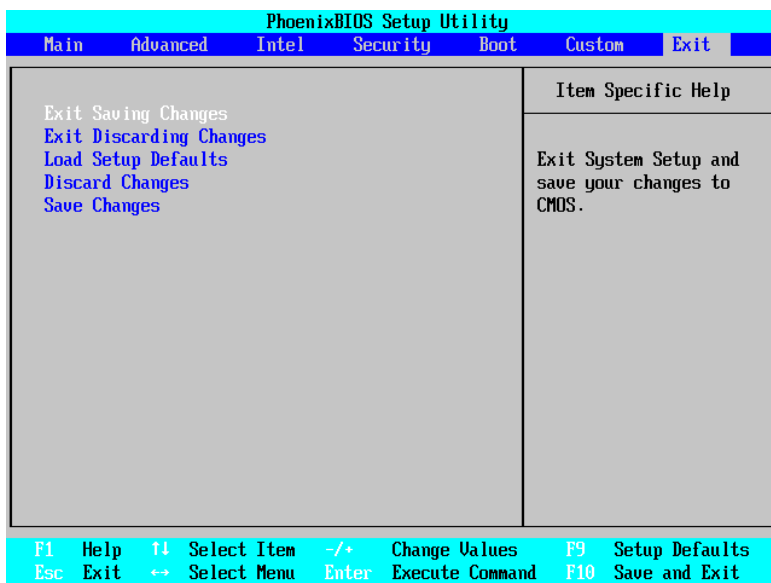

Note that <Esc> does not exit this menu. You must select one of the items from the menu to exit. Here you can select whether or not to save changes made to BIOS parameters during the current session to CMOS memory and exit BIOS Setup utility.

Chapter

4

**Driver
Installation**

The AEC-7450 comes with a CD-ROM that contains all drivers and utilities that meet your needs.

OS	Description	File Name
Windows XP *	Audio Driver	/win2k_xp/audio/
	Chipset Driver	/win2k_xp/chipset/
	Ethernet Driver	/win2k_xp/eth/
	Video Driver	/win2k_xp/graphics/
	ISA Bridge Driver	/win2k_xp/ite8888
Linux 2.4	Ethernet Driver	/linux/eth/
	DRI Video Driver	/linux/graphics/

* - fully compatible with Windows XP Professional SP2.

4.1 Installation

Insert the AEC-7450 CD-ROM into the CD-ROM Drive. The Autorun program will run automatically. You also can choose the drivers to install from as following instructions.

Windows XP

- **Install Audio Driver**

1. Double click the System icon to open up your System Properties window.
2. Click **Hardware** and then **Device Manager** in the **System Properties** window.
3. Right click the drive and select update driver.
4. In this wizard's window check "Yes, this time only" and press Next.
5. In next window check "Install from a list or specific location" and press Next.
6. In next window check "Don't search. I will choose the driver to install" and press Next.
7. Press "Have disk" button, then browse driver (\win2k_xp\audio) and press "OK".
8. To start installation press "Next" .
9. To complete installation press "Finish" .



- **Install Chipset Driver**

1. Click on the win2k_xp\chipset folder and then double click on the **infnst_enu.exe**
2. Follow the instructions that the window will show you
3. The system will help you install the driver automatically

- **Install LAN Driver**

1. Click on the win2k_xp\eth folder and then double click on the **PRO2KXP.exe**
2. Follow the instructions that the window shows you
3. The system will help you install the driver automatically

- **Install Graphics Driver**

1. Click on the **win2k_xp\graphics** folder and then click on the folder of Windows
2. Double click on the **win2k_xp141950.exe**
3. Follow the instructions that the window shows you
4. The system will help you install the driver automatically

- **Install ISA bridge Driver**

1. Double click the System icon to open up your System Properties window.
2. Click **Hardware** and then **Device Manager** in the **System Properties** window.
3. Right click the drive and select update driver.

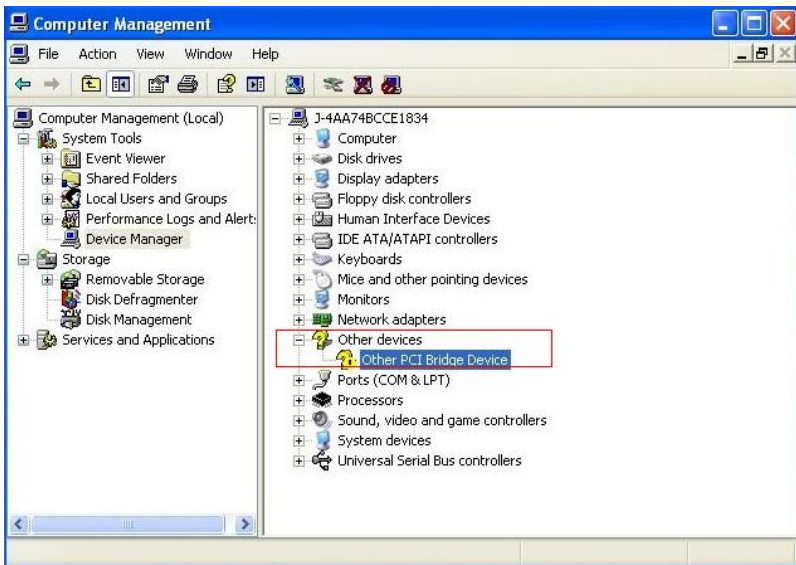

4. In this wizard' s window check “Yes, this time only” and press Next.
5. In next window check “Install from a list or specific location” and press Next.
6. In next window check “Don’ t search. I will choose the driver to install” and press Next.
7. Press “Have disk” button, then browse driver (\win2k_xp\ite8888) and press “OK” .
8. To start installation press “Next” .
9. To complete installation press “Finish” .

Linux 2.4

- **Install Ethernet driver**

1. To uncompress the files (or to get the files out of a tarball), please use the following commands in linux.

tar xvfz e1000-7.2.9.tar.gz

- **Install Graphics driver**

1. To uncompress the files (or to get the files out of a tarball), please use the following commands in linux.

tar xvfz Intel-3.4.3006-20051209.i386.tar.gz

Appendix

A

Programming the Watchdog Timer

A.1 Programming

The watchdog timer eliminates system hang-ups both during the start-up process (for example, in case of mistakes in BIOS, when the additional timer is not able to restart the system) and during normal operation. The timeout period is set in BIOS Setup program. On the expiry of the timeout period the watchdog timer issues "Reset" signal. During start-up process watchdog timer monitors BIOS code execution. If BIOS error is detected, the system is automatically reset and red D7 LED is lit indicating system failure state. The instructions on watchdog timer programming can be found in the following subsections.

- **Watchdog Timer**

FPGA XILINX XC3S200 is also used to control the watchdog timer. 17 lower bits of the 24-bit WD FPGA register are used to program the watchdog timeout period. It is possible to set the timeout period from 0 to 512 seconds with increments of 30.52 ms by changing the value in this register.

By default, without prior initialization, the watchdog timeout period is set to maximum that is 512 seconds. The equation below can be used to calculate the timeout TWD in ms as a function of the decimal value in the WD register (KWD):

$$\text{TWD [ms]} = \text{KWD} * 106 / 215$$

For example, decimal value "1" of KWD (000001h) corresponds to the timeout of 30.52 ms, and KWD = 16777215 (FFFFFFh) – 512

seconds.

2.2.3.1 Access to Watchdog Registers

The unit's configuration is based on Plug-and-Play architecture.

Watchdog timer registers are available via standard I/O registers (Index and Data ports) in configuration mode.

Port	Address	Operation
Config Port	302h	Write
Index Port	302h	Read/Write
Data Port	303h	Read/Write

- **Configuration Mode**

Configuration mode is enabled by writing <46h><57h> to Config Port. Configuration mode is disabled by writing <57h><46h> to Config Port. Index and Data ports are available in configuration mode only.

- **Watchdog Timer Programming**

The procedures of watchdog programming is described below:

- Enter configuration mode

```
MOV DX, 302H
```

```
MOV AL, 46H
```

```
OUT DX, AL
```

```
MOV AL, 57H
```

```
OUT DX, AL
```

- Write to LDN register a logic device number (watchdog timer has logical number 1)

```
MOV DX, 302H
```

```
MOV AL, 7
```

```
OUT DX, AL
```

```
MOV DX, 303H
```

```
MOV AL, 1
```

```
OUT DX, AL
```

- Watchdog timer registers are available for read and write now.

For example, to read status register 3eh and to write the value from it back:

```
MOV DX, 302H
```

```
MOV AL, 3EH
```

```
OUT DX, AL
```

MOV DX, 303H

IN AL, DX

OUT DX, AL

· To exit configuration mode:

MOV DX, 302H

MOV AL, 57H

OUT DX, AL

MOV AL, 46H

OUT DX, AL

● Global Configuration Registers

Index	Type	Hard Reset	Configuration Register
7h	R/W	01h	Logical Device Number

● Logical Device Number register (index 7h)

Index = 7h		
Bit	Name	Description
7:1	-	Not used
0	LDN	Write/Read: Writing to this register selects logical device.

● Logical Devices Configuration Registers

Index	Type	Hard Reset	Configuration Register
30h	R/W		Activate
60h	R/W		I/O port base address bits [15:8]
61h	R/W		I/O port base address bits [7:0]
70h	R/W	00h	Primary interrupt select

● **Activate register**

Index = 30h		
Bit	Name	Description
7:1	-	Not used
0	Activate	Write/Read: 1 – Current logical device enabled 0 – Current logical device disabled

● **I/O port base address registers**

Index = 60h		
Bit	Name	Description
7:1	-	Not used
0	I/O_Base_Adres[15:8]	Write/Read: Current logical device base address bits 15:8
Index = 61h		
Bit	Name	Description
7:1	-	Not used
0	I/O_Base_Adres[7:0]	Write/Read: Current logical device base address bits 7:0

● **Primary interrupt select register**

Index = 70h		
Bit	Name	Description
7:4	-	Not used
3:0	Interrupt_select	Write/Read: 00h – Interrupt disabled 01h – IRQ1 02h – SMI 03h – IRQ3 04h – IRQ4 05h – IRQ5 06h – IRQ6 07h – IRQ7 08h – IRQ8 09h – IRQ9 0ah – IRQ10 0bh – IRQ11 0ch – IRQ12 0dh – IRQ13 0eh – IRQ14 0fh – IRQ15

- **Watchdog Timer Registers (Logical Device 1)**

Index	I/O Port Address	Type	Hard Reset	Configuration Register
30h	–	R/W		Activate
38h	Base+0	R/W		Timer current value [7:0]
39h	Base+1	R/W		Timer current value [15:8]
3ah	Base+2	R/W		Timer current value [23:16]
3bh	Base+3	R/W	00h	Timer initial value [7:0]
3ch	Base+4	R/W	40h	Timer initial value [15:8]
3dh	Base+5	R/W	00h	Timer initial value [23:16]
3eh	Base+6	R/W	00h	Status register
3fh	Base+7	R/W	03h	Control register
60h	–	R/W		Base [15:8] – I/O port base address bits [15:8]
61h	–	R/W		Base [7:3] – I/O port base address bits [7:3] Base [2:0] – should be 0
70h	–	R/W	00h	Primary interrupt select