

AEC-6820B

Fanless Embedded Control PC

VIA Eden 677MHz/ C3 1GHz

CPU With 2 PCMCIA slots,

Ethernet, 2 COMs, Audio,

CompactFlash[™]

AEC-6820B Manual 1st Ed.

July 2005

Copyright Notice

This document is copyrighted, 2005. All rights are reserved. The original manufacturer reserves the right to make improvements to the products described in this manual at any time without notice.

No part of this manual may be reproduced, copied, translated, or transmitted in any form or by any means without the prior written permission of the original manufacturer. Information provided in this manual is intended to be accurate and reliable. However, the original manufacturer assumes no responsibility for its use, or for any infringements upon the rights of third parties that may result from its use.

The material in this document is for product information only and is subject to change without notice. While reasonable efforts have been made in the preparation of this document to assure its accuracy, AAEON assumes no liabilities resulting from errors or omissions in this document, or from the use of the information contained herein.

AAEON reserves the right to make changes in the product design without notice to its users.

Acknowledgments

All other products' name or trademarks are properties of their respective owners.

- Award is a trademark of Award Software International, Inc.
- CompactFlash™ is a trademark of the Compact Flash Association.
- VIA Eden™ is a trademark of VIA Technology Inc.
- Microsoft Windows® is a registered trademark of Microsoft Corp.
- PC/AT, PS/2, and VGA are trademarks of International Business Machines Corporation.

Please be notified that all other products' name or trademarks not be mentioned above are properties of their respective owners.

Packing List

Before you begin operating your PC, please make sure that the following materials have been shipped:

- 1 AEC-6820B Embedded Control PC
- 1 Keyboard & mouse cable
- 1 Phoenix Power Connector
- 2 Wallmount Bracket
- 1 Audio Cable
- 1 Screw Package
- 1 CD-ROM for manual (in PDF format) and drivers

If any of these items should be missing or damaged, please contact your distributor or sales representative immediately.

Safety & Warranty

1. Read these safety instructions carefully.
2. Keep this user's manual for later reference.
3. Disconnect this equipment from any AC outlet before cleaning.
Do not use liquid or spray detergents for cleaning. Use a damp cloth.
4. For a pluggable equipment, the power outlet must be installed near the equipment and must be easily accessible.
5. Keep this equipment away from humidity.
6. Put this equipment on a reliable surface during installation.
Dropping it or letting it fall could cause damage.
7. The openings on the enclosure are for air convection. Protect the equipment from overheating. **DO NOT COVER THE OPENINGS.**
8. Make sure the voltage of the power source is correct before connecting the equipment to the power outlet.
9. Position the power cord so that people cannot step on it. Do not place anything over the power cord.
10. All cautions and warnings on the equipment should be noted.
11. If the equipment is not used for a long time, disconnect it from the power source to avoid damage by transient over-voltage.
12. Never pour any liquid into an opening. This could cause fire or electrical shock.
13. Never open the equipment. For safety reasons, only qualified service personnel should open the equipment.
14. If any of the following situations arises, get the equipment checked by service personnel:

- a. The power cord or plug is damaged.
 - b. Liquid has penetrated into the equipment.
 - c. The equipment has been exposed to moisture.
 - d. The equipment does not work well, or you cannot get it to work according to the users manual.
 - e. The equipment has been dropped and damaged.
 - f. The equipment has obvious signs of breakage.
15. DO NOT LEAVE THIS EQUIPMENT IN AN ENVIRONMENT WHERE THE STORAGE TEMPERATURE IS BELOW -20°C (-4°F) OR ABOVE 60°C (140°F). IT MAY DAMAGE THE EQUIPMENT.

FCC Safety

Warning!



This device complies with Part 15 FCC Rules. Operation is subject to the following two conditions: (1) this device may not cause harmful interference, and (2) this device must accept any interference received including interference that may cause undesired operation.

Caution:

It may cause danger of explosion if battery is incorrectly replaced. Replace only with the same or equivalent type recommended by the manufacturer. Dispose of used batteries according to the manufacturer's instructions.

Contents

Copyright Notice	2
Acknowledgments.....	3
Packing List	4
Safety & Warranty.....	5
FCC Safety	6
1.1 Introduction.....	9
1.2 Features	10
1.3 Specifications	11
2.1 Dimension	15
2.2 HDD Module Installation.....	16
2.3 SDRAM Installation	21
2.4 COM2 RS-232/422/485 Setting	23
2.5 Power Linkage Installation	24
2.6 Wallmount Installation	26
2.7 DIN Rail Installation.....	27
2.8 COM2 RS-232/422/485 Serial Port Connector	28
2.9 COM1 RS-232 Serial Port Connector	28
3.1 System Test and Initialization	30
3.2 Award BIOS Setup	31
4.1 Installation 1	36
4.2 Installation 2	37
A.1 Programming the Watchdog timer	39

Chapter

1

**General
Information**

1.1 Introduction

The AEC-6820B is an Embedded Control PC with PCMCIA slots that supports different interfaces with wireless functions. Anti-vibration and high temperature tolerances are the main design features of the AEC-6820B. This allows the AEC-6820B to be installed in a rugged transportation environment despite high ambient vibration and temperature.

The AEC-6820B continues the design concept of the AEC-6810 but focuses on the Intelligent Transportation System (ITS) market. Because of the shortage of the Transmeta CPU found in the original AEC-6820, the AEC-6820B adopts the VIA Eden EBGA mobile processor up to 1GHz. This is not only for providing a long-term supply of AEC-6820B to our valuable customers, but it also reduces the cost of integration.

In addition to the fanless CPU, the AEC-6820B features two PCMCIA expansion slots for mobile devices. One concept for an ITS would be to use the two PCMCIA slots to communicate with a control center for vehicle data recording through wireless applications. A DC power supply is commonly used in most vehicles and factory equipments. The AEC-6820B can be powered by a DC 9~30V input with low power consumption and high performance. You can also choose an additional external AC

power adapter for power redundancy purposes. AAeon provides flexible power choices for customers who choose the AEC-6820B.

Transportation has become part of most people's life and forms a necessary part of their lifestyle. From cars to trains to ships and airplanes, we rely on those tools a lot. The AEC-6820B is designed to improve transportation control and enhance the quality of our lives.

1.2 Features

- Fanless Design with VIA Eden 667MHz/C3 1GHz processor
- 2 PCMCIA slots for expansion
- DC 9~30V input with Phoenix connector and optional external AC power adapter
- Front accessible USB port for system control and data transfer
- WinCE.net / CFD / Optional 2.5" HDD kit
- Ethernet /2 COM / 4 USB / Audio
- Operating Temperature: -15°C ~65°C (-5°F~149°F)
- Anti-vibration up to 6 g rms / Anti-shock up to 100g
- CE / FCC class B certified

1.3 Specifications

System

- CPU: VIA Eden 667MHz / C3 1GHz
- Memory: SDRAM SODIMM x 1, Max. 512MB
- Expansion: PCMCIA x 2
- VGA: D-sub 15 VGA Connector
- Keyboard/Mouse: PS/2 Keyboard & Mouse
- Ethernet: 10/100Base-TX Ethernet RJ-45 connector x 1
- SSD: Type II CompactFlash™ slot
- Hard Disk Storage: Optional 2.5" Slim HDD Module
- Serial Port: 1 x RS-232, 1 x RS-232/422/485
- Audio: Mic-in / Line-in / Line-out, by extension cable
- USB: 4 USB 1.1 Ports
- Parallel Port: 1 Parallel Port
- Watchdog Timer: Generates a time-out system reset
- Power Supply: DC Input: 9V DC~30V DC
AC Input: External Power Adapter (Optional)
- System Control: Power on / off switch x 1; Reset button x 1
- Indicator: Power LED x 1

HDD active LED x 1

Mechanical and Environmental

- Construction: Aluminum Alloy chassis
- Color: Dark Blue
- Mounting: Wallmount (Default), DIN-Rail
- Dimension: 8.35" (W) x 2.53" (H) x 4.21" (D)
212.15mm x 64.2mm x 107mm
- Net Weight: 4.75lb (2.16kg)
- Gross Weight: 8.36lb (3.8kg)
- Operation Temperature:
5°F ~ 149°F (-15°C ~ 65°C)(CFD)
- Operation Humidity: 5~95% @40°C, non-condensing
- Vibration:
6 g rms / 5~500Hz / random
operation (Without HDD Module)
1 g / 5~500Hz / random operation
(With HDD Module)
- Shock: 100g peak acceleration (11 msec.
duration)
- EMC: CE/FCC class B

Front Side

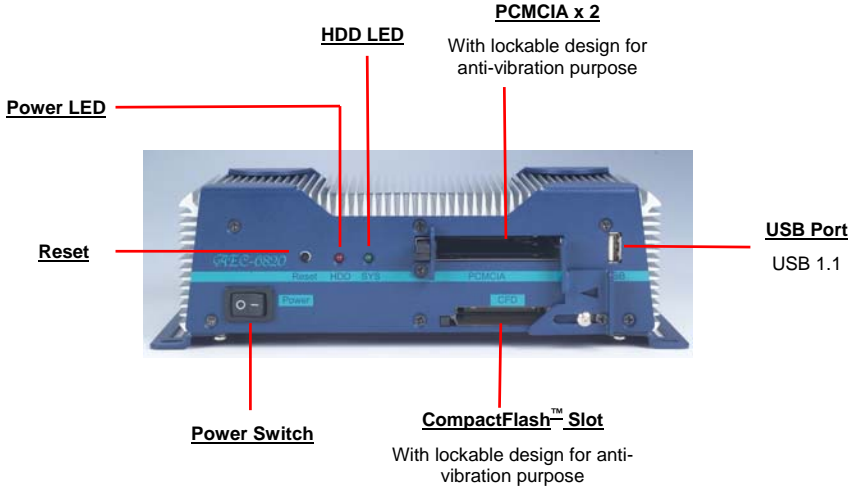

Rear Side

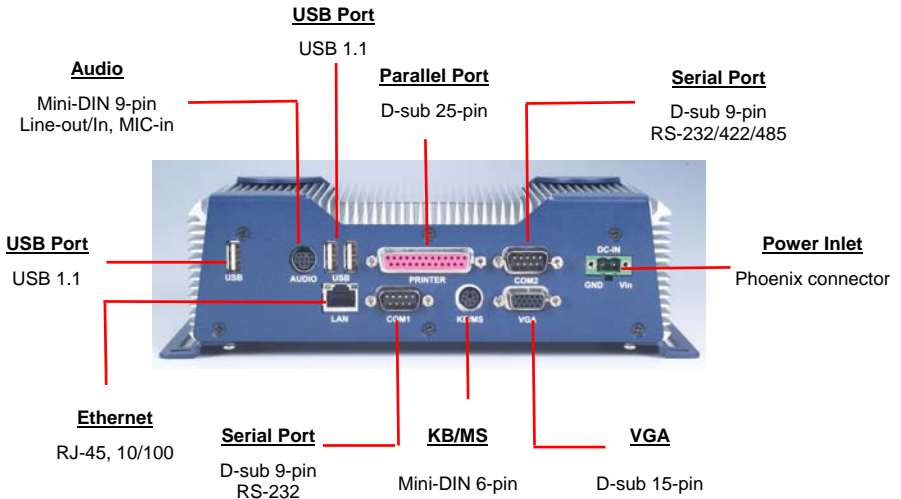

Chapter

2

**Hardware
Installation**

2.1 Dimension

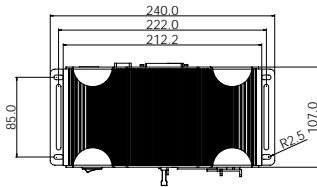

AEC-6820B

Units:mm

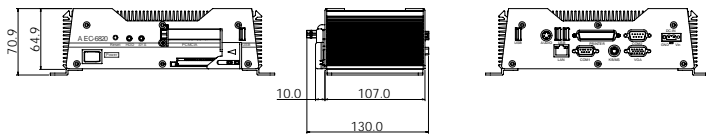

2.2 HDD Module Installation

Cable Insertion

Step 1: Open the HDD cover by loosening the screws on the bottom of the chassis.

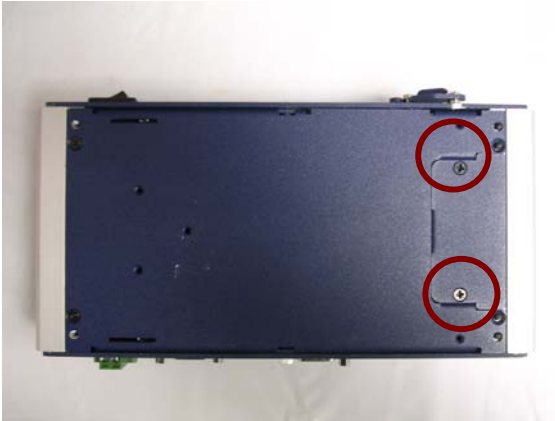

Step 2: Insert the Cable to the bottom of the chassis as the illustration below.

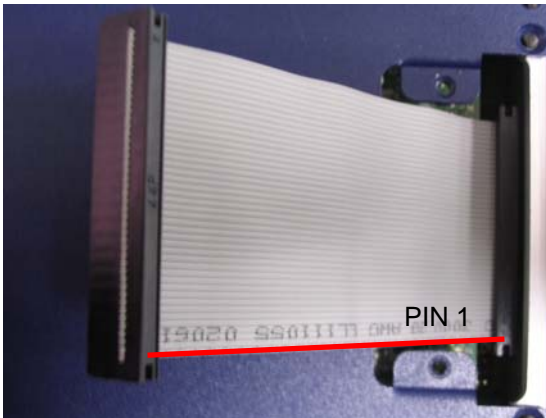
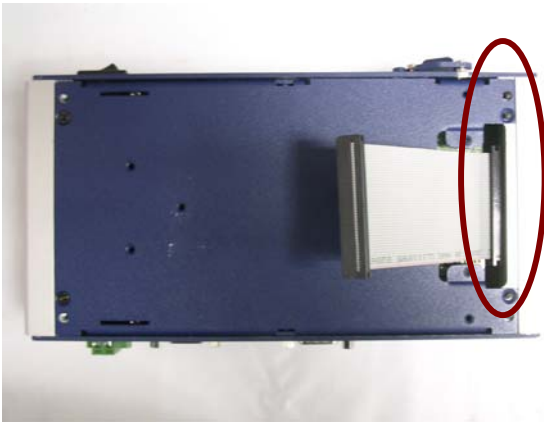

HDD Kit Combination

Get the HDD and bracket ready.

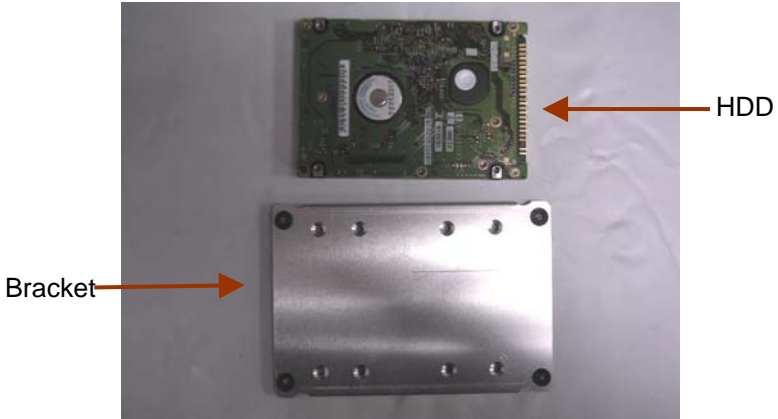

Step 1: Stack the HDD and bracket. Fasten HDD and bracket with the screws.

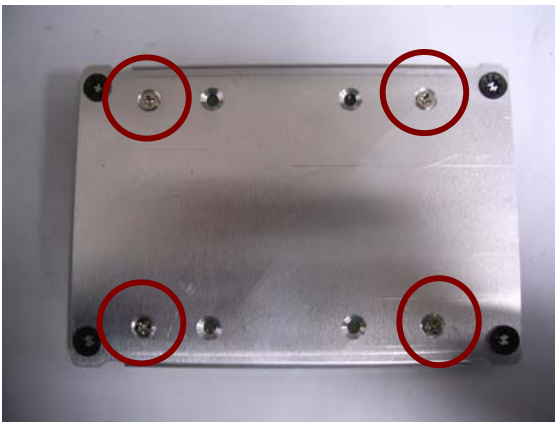

Step 2: Fasten the HDD module into the HDD kit house.



Step 3: Insert the other side of the cable to the HDD module.



Step 3: Combine the HDD kit house with the chassis and push as the illustration shown below.

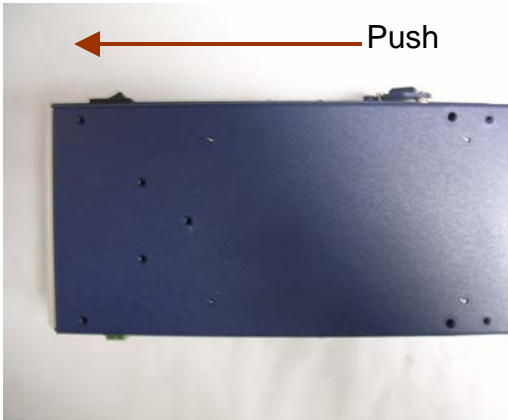

Step 4: Lock with the screws.

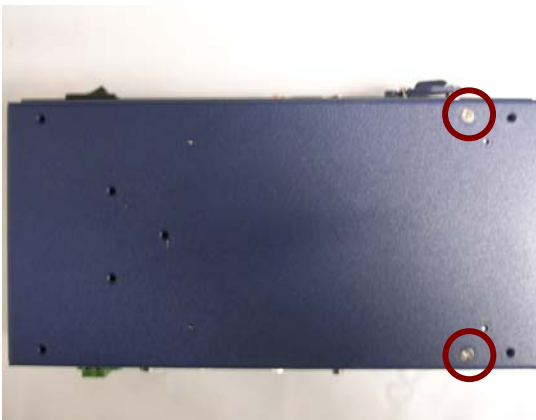

Step 2: Remove the lid and insert the SDRAM SODIMM module into the slot.

SDRAM
SODIMM
module



2.4 COM2 RS-232/422/485 Setting

RS-232/422/485 Selection (JP4 & JP5 & JP6)

The following table provides the user to set up COM2 port.

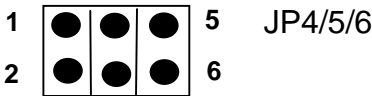

JP4	Function
1-2	RS-232 (Default)
3-4	RS-422
5-6	RS-485

JP5	Function
1-3,2-4	RS-232 (Default)
3-5,4-6	RS-422
3-5,4-6	RS-485

JP6	Function
1-3,2-4	RS-232 (Default)
3-5,4-6	RS-422
3-5,4-6	RS-485



2.5 Power Linkage Installation

Step 1: Get the cable and connector ready



Step2: Fix the connector to the cable with the screws.



Step3: Insert the power cable in.



Step 4: Screw the power cable into the chassis.



Notice:

Please make sure that pin assignment of **Power** and **Ground** on the accurate location.

2.6 Wallmount Installation

Fasten the brackets with the screws.



2.7 DIN Rail Installation

Step 1: Fix the DIN Rail kit with the screws on the chassis as the illustration shown.



Step 2: Press the DIN Rail on the DIN Rail kit to fix it.

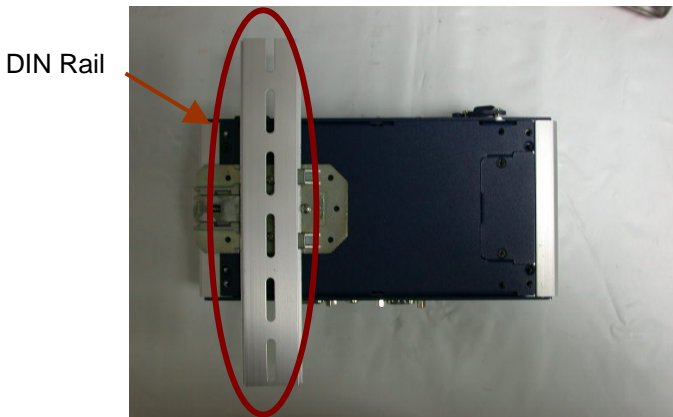

2.8 COM2 RS-232/422/485 Serial Port Connector

Different devices implement the RS-232/422/485 standard in different ways. If you are having problems with a serial device, be sure to check the pin assignments below for the connector.

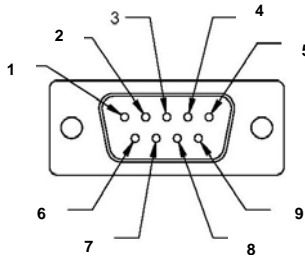

Pin	Signal	Pin	Signal
1	DCD (422TXD-/485DATA-)	2	RXD (422RXD+)
3	TXD (422TXD+/485DATA+)	4	DTR (422RXD-)
5	GND	6	DSR
7	RTS	8	CTS
9	RI	10	N.C.

2.9 COM1 RS-232 Serial Port Connector

Pin	Signal	Pin	Signal
1	DCD	2	RXD
3	TXD	4	DTR
5	GND	6	DSR
7	RTS	8	CTS
9	RI	10	N.C.

Chapter

3

Award BIOS Setup

3.1 System Test and Initialization

These routines test and initialize board hardware. If the routines encounter an error during the tests, you will either hear a few short beeps or see an error message on the screen. There are two kinds of errors: fatal and non-fatal. The system can usually continue the boot up sequence with non-fatal errors. Non-fatal error messages usually appear on the screen along with the following instructions:

Press <F1> to RESUME

Write down the message and press the F1 key to continue the boot up sequence.

System configuration verification

These routines check the current system configuration against the values stored in the CMOS memory. If they do not match, the program outputs an error message. You will then need to run the BIOS setup program to set the configuration information in memory.

There are three situations in which you will need to change the CMOS settings:

1. You are starting your system for the first time
2. You have changed the hardware attached to your system
3. The CMOS memory has lost power and the configuration information has been erased.

The AEC-6820B CMOS memory has an integral lithium battery backup for data retention. However, you will need to replace the complete unit when it finally runs down.

3.2 Award BIOS Setup

Awards BIOS ROM has a built-in Setup program that allows users to modify the basic system configuration. This type of information is stored in battery-backed CMOS RAM so that it retains the Setup information when the power is turned off.

Entering Setup

Power on the computer and press immediately. This will allow you to enter Setup.



Standard CMOS Features

Use this menu for basic system configuration. (Date, time, IDE, etc.)

Advanced BIOS Features

Use this menu to set the advanced features available on your system.

Advanced Chipset Features

Use this menu to change the values in the chipset registers and optimize your system performance.

Integrated Peripherals

Use this menu to specify your settings for integrated peripherals. (Primary slave, secondary slave, keyboard, mouse etc.)

Power Management Setup

Use this menu to specify your settings for power management. (HDD power down, power on by ring, KB wake up, etc.)

PnP/PCI Configurations

This entry appears if your system supports PnP/PCI.

PC Health Status

This menu allows you to set the shutdown temperature for your system.

Frequency/Voltage Control

Use this menu to specify your settings for auto detect DIMM/PCI clock and spread spectrum.

Load Fail-Safe Defaults

Use this menu to load the BIOS default values for the minimal/stable performance for your system to operate.

Load Optimized Defaults

Use this menu to load the BIOS default values that are factory settings for optimal performance system operations. While AWARD has designated the custom BIOS to maximize performance, the factory has the right to change these defaults to meet their needs.

Set Supervisor/User Password

Use this menu to set Supervisor/User Passwords.

Save and Exit Setup

Save CMOS value changes to CMOS and exit setup.

Exit Without Saving

Abandon all CMOS value changes and exit setup.

You can refer to the "AAEON BIOS Item Description.pdf" file in the CD for the meaning of each setting in this chapter.

Chapter

4

Driver Installation

The AEC-6820B comes with a CD-ROM which contains most of drivers and utilities of your needs.

There are several installation ways depending on the driver package under different Operating System application.

If you utilize Windows NT series OS, you are strongly recommended to download the latest version Windows NT Service Pack from Microsoft website and install it before installing any driver.

Please follow the sequence below to install the drivers:

Step 1 – Install System Driver

Step 2 – Install VGA Driver

Step 3 – Install Audio Driver

Step 4 – Install LAN Driver

For installation procedures of each driver, you may refer to section 4.1 to 4.2.

4.1 Installation 1

Applicable for Windows 2000/98/ME/XP

1. Insert the AEC-6820B CD-ROM into the CD-ROM Drive.
2. From the CD-ROM, select the desired component Driver folder, and then select the desired Operation System folder to double click on the Setup.exe icon. A driver installation screen will appear.

Notice:

Take VGA driver installation under Windows 98 for example, choose the corresponding folder depending on your OS.

3. A driver installation screen will appear, please follow the onscreen instructions to install the driver in sequence and click on the Next button.

Notice:

In some cases the system will ask you to insert Windows 98 CD ROM and key in its path. Then click on the OK button to key in path.

4. Click on the **Finish** button to finish installation process. And allow the system to reboot.

4.2 Installation 2

Applicable for Windows 2000/ 98/ME/XP

1. Insert the **AEC-6820B CD-ROM** into the CD-ROM Drive.
2. Click on **Start** button, select the **Settings**, and then click on the **Control Panel** icon.
3. Double click on the **Add/Remove Hardware** icon and **Add New Hardware Wizard** will appear. Click on the **Next** button.
4. Select **Search for the best driver for your device (Recommended)** and click on the **Next** button.
5. Select **Specify a location**, click on **Have Disk** button then key in the CD-ROM path and specify component drivers and OS folders. Then click on the **Next** button.
6. The Wizard shows that Windows driver file search for the device. Click on the **Next** button.
7. The system will ask you to insert Windows 98 CD ROM. Click on the **OK** button to insert CD-ROM and key in path.
8. Click on the **OK** button.
9. Click on the **Finish** button to finish installation process. And allow the system to reboot.

Appendix

A

Programming the Watchdog Timer

A.1 Programming the Watchdog timer

AEC-6820B contains a watchdog timer reset pin. (GP16)

All reference material can be found on the following pages.

```
=====*
```

```
*
** Title : WatchDog Timer Setup Utility (for W83977 GP16) **
** Company : AAEON Technology Inc. **
** Compiler : Borland C ++ Version 3.0 **
**=====
=====*/
```

```
#include <dos.h>
```

```
#include <io.h>
```

```
#include <bios.h>
```

```
#include <stdio.h>
```

```
#include <stdlib.h>
```

```
#include <conio.h>
```

```
/* Set I/O Address : 370/371 or 3F0/3F1 */
```

```
#define IO_INDEX_PORT  0x370
#define IO_DATA_PORT   0x371

/* Set Watchdog reset pin : 12/13/16 */
#define watch_dog_output_GP 16

#define UNLOCK_DATA    0x87
#define LOCK_DATA      0xAA
#define DEVICE_REGISTER 0x07

void EnterConfigMode()
{
    outportb(IO_INDEX_PORT, UNLOCK_DATA);
    outportb(IO_INDEX_PORT, UNLOCK_DATA);
}

void ExitConfigMode()
{
    outportb(IO_INDEX_PORT, LOCK_DATA);
```

```
}  
  
void SelectDevice(unsigned char device)  
{  
    outportb(IO_INDEX_PORT, DEVICE_REGISTER);  
    outportb(IO_DATA_PORT, device);  
}  
  
unsigned char ReadAData(short int reg)  
{  
    outportb(IO_INDEX_PORT, reg);  
    return (inportb(IO_DATA_PORT));  
}  
  
void WriteAData(unsigned char reg, unsigned char data)  
{  
    outportb(IO_INDEX_PORT, reg);  
    outportb(IO_DATA_PORT, data);  
  
}
```

```
void SetWatchDogTime(unsigned char time_val)
{
    EnterConfigMode();
    SelectDevice(8);
    //Set Register F2
    //Set Watch-Dog Timer 1~ 256
    WriteAData(0xF2, time_val);
    // set counter counts in second (or minute)
    // Register F4 Bit 6 = 0/1 (minutes/seconds)
    // For w83977EF only
    WriteAData(0xF4, 0x40);
    ExitConfigMode();
}

void init_w83977f_aw_watchdog()
{
    short int value;
```

```
//Enter W83977 Configure Mode
EnterConfigMode();

//Select Device 7
SelectDevice(7);

//Set Device Active
WriteAData(0x30, 0x01);

//caution:skip this step will be a mistake!!
if (watch_dog_output_GP==12)
{
    //Set Register E2 to define GP12
    WriteAData(0xE2, 0x0A);
}
else if(watch_dog_output_GP==13)
{
    //Set Register E3 to define GP13
    WriteAData(0xE3, 0x0A);
}
```

```
else if(watch_dog_output_GP==16)
{
    //Set Register E6 to define GP16
    WriteAData(0xE6, 0x0A);
}

//Select Device 8
SelectDevice(8);

//Set Register F3
//keyboard and mouse interrupt reset Enable
//When Watch-Dog Time-out occurs,Enable POWER LED output
WriteAData(0xF3, 0x0E);

//caution:skip this step will be a mistake!!
if (watch_dog_output_GP==12)
{
    //Set Register 2A (PIN 57) Bit 7 = 0/1 (KBLOCK/GP12)
    //set to GP12 for WD Rst
    WriteAData(0x2A,ReadAData(0x2A)|0x80);
}
```

```
else if(watch_dog_output_GP==13)
{
//Set Register 2B (PIN 58) Bit 0 = 0/1 (KBLOCK/GP13)
//set to GP13 for WD Rst
WriteAData(0x2B,ReadAData(0x2B)|0x01);
}
else if(watch_dog_output_GP==16)
{
//Set Register 2C (PIN 119) Bit 5-4 = 01 (GP16)
//set to GP16 for WD Rst
WriteAData(0x2C,ReadAData(0x2C)|0x10);
}

//Exit W83977 Configure mode
ExitConfigMode();
}

void main(int argc, char* argv[])
{
```

```
int time_value=0;

char *ptr;

printf("winBond 83977 WatchDog Timer Setup Utility Version 1.0
\n" );

printf("Ccopyright (c) 2000 AAEON Technology Inc.\n");

printf("Tthis version only for W83977 that using GP%d to Reset
System.\n",watch_dog_output_GP);

if (argc == 1)
{
    printf("\n Syntax: WATCHDOG [time] \n" );
    printf(" time range : 1 ~ 256 \n\n" );
    return ;
}

if (argc > 1)
{
    ptr = argv[1];
    time_value = atoi(ptr);
}
}
```

```
if (time_value > 0 && time_value < 256)
{
SetWatchDogTime((unsigned char) time_value);
init_w83977f_aw_watchdog();
printf("Watch Dog Timer set up : %d \n",time_value);
}
}
```